

VGC-301 Vacuum Gauge Controller



User's Manual

**Revision: 1.02
1 June 2005**

1475 S. Fordham St.
Longmont, CO 80503
Phone 303-651-0551
Fax 303-678-1754
E-mail info@instrutechinc.com



LAB Online Exhibition



Table of Contents

	<u>page</u>
Introduction / General Information	
Description	3
Specifications	3
Options & Accessories	3
Safety	
General	4
Service and Operation	4
Electrical	4
Overpressure	4
Gases other than N ₂	5
Flammable/Explosive Gases	5
Installation	
Mounting	6
Electrical Connections	7
Setup & Operation	
User Interface Basics	9
Menu Item Explanations	9
Calibration	10
Interface	
RS-485/RS-232 Commands	11
Service	
Maintenance	12
Cleaning	12
Troubleshooting	12
Factory Default Reset	13
Factory Service and Support	13
Trademarks & Acknowledgements	13
Appendices	
A. User interface map	14
B. Using thermal vacuum gauges with different gases	16
C. Vacuum gauge contamination & cleaning	23

Introduction / General Information

Description

The VGC-301 vacuum gauge controller is a convenient and inexpensive power supply and readout instrument for a CVG "Worker Bee" convection vacuum gauge. The 1/8-DIN housing can be used on the bench top or mounted in a cutout in an instrument panel. The VGC-301 is powered by 12-30 VDC, or by its self-contained universal 100-240VAC supply.

Compatibility: Signals and relay functions are the same as found on similar convection gauge controllers from other manufacturers. The VGC-301, CVG gauge, and gauge cable can be directly interchanged with Granville-Phillips 375 Controller, 275 Convector[®] gauge, and gauge cable. (Remote interface, relay, and power connectors are different.)

Specifications

measurement range	1x10 ⁻⁴ to 1000 Torr 1x10 ⁻⁴ to 1333 mbar 1x10 ⁻² Pa to 133 kPa
resolution	1x10 ⁻⁴ Torr / 1x10 ⁻⁴ mbar / 1x10 ⁻² Pa
display	Four-digit LCD, displays 4 digits from 100 mTorr to 1100 Torr 3 digits from 10.0 to 100 mTorr 2 digits from 1.0 to 10 mTorr
display engineering units	Torr, mbar, or Pa - user selectable
display update rate	0.5 sec
weight	250 gm (9 oz)
operating temperature	0 to +40 °C ambient
storage temperature	-40 to +70 °C
humidity	0 to 95% RH non-condensing
analog output (user-selectable)	a) non-linear S-curve 0.375 to 5.659 Vdc, or b) linear 0 to 10 Vdc, user scalable (default is 10Vdc = 1 Torr), or c) log-linear 1 to 8 Vdc, 1V/decade
digital interface	RS232 and RS485
housing	1/8-DIN panel-mount enclosure (see outline drawing for dimensions)
input power	100-240 Vac, 50/60Hz, universal power supply or 12-30 Vdc
setpoint relays	two single-pole double-throw relays (SPDT)
contact rating	1A at 30 Vdc resistive, or ac non-inductive
trippoint range	1x10 ⁻³ to 1000 Torr
adjustment	a) adjust value by panel pushbutton up/down keys and display b) adjust value, direction, and hysteresis by software/interface
connectors	gauge: 9-pin D female analog output and digital interface: 9-pin D male relay outputs: 6-pin pluggable terminal block power: universal AC and 2-pin pluggable terminal block DC
RF/EMI protection	CE compliant

Options & Accessories

Gauge Cable - Connects VGC-301 to InstruTech CVG-101 Worker Bee or Helix/GP 275 Convector[®] gauge tube

10 ft (3m)	CB 421-1- 10F
20 ft (6m)	CB 421-1- 20F
50 ft (15m)	CB 421-1- 50F
custom lengths over 50 ft (15m), up to 100 ft (30 m)	CB 421-1 - xxxF or - yyM

Connector Kit - One set of mating connectors is included with the VGC-301: one AC Cord , one 6-pin pluggable terminal strip connector, and one 2-pin pluggable terminal strip connector. (Does not include gauge cable connector - part of cable above.) To order a spare set of connectors separately ...

CK-431-xx

Safety

Instrutech has designed and tested this product to provide safe and reliable service, provided it is installed and operated within the *strict safety guidelines provided in this manual*. **Please read and follow all warnings and instructions. Failure to comply with these safety procedures may result in serious bodily harm, including death, and or property damage.** Failure to comply with these warnings violates the safety standards of the installation and intended use of the instrument. Instrutech, Inc. disclaims all liability for the customer's failure to comply with these requirements.

Although every attempt has been made to consider most possible installations, Instrutech cannot anticipate every contingency that arises from various installations, operation, or maintenance of the module. If you have any questions about the safe installation and use of this product, please contact Instrutech at the address shown on page 1 of this manual.

Service and operation

Do not modify this product or substitute any parts without authorization of a qualified Instrutech technician. Return the product to an Instrutech qualified service and repair center to ensure that all safety features are maintained. Do not use this product if unauthorized modifications have been made.

After servicing this product, ensure that all safety checks are made by a qualified service person. Replacement Parts: When replacement parts are required, ensure that the parts are specified by Instrutech Inc. Unauthorized substitutions or non-qualified parts may result in fire, electric shock, or other hazards.

To reduce the risk of fire or electric shock, do not expose this product to rain or moisture. This product is not waterproof and careful attention must be paid to not spill any type of liquid onto this product.

Due to the possibility of corrosion under certain environmental conditions, it is possible that the product's safety could be compromised over time. It is important that the product be periodically inspected for sound electrical connections and grounding. Do not use if the grounding or electrical insulation has been compromised.

Electrical conditions:

Danger: When high voltage is present in any vacuum system, a life threatening electrical shock hazard may exist unless all exposed conductors are maintained at earth ground. This applies to all products that come in contact with the gas.

Danger: An electrical discharge through a gas may couple dangerous high voltage directly to any ungrounded conductor. A person may be seriously injured or killed by coming in contact with an exposed ungrounded conductor at a high voltage potential. This applies to all products that may come in contact with the gas.

Proper Grounding: Verify that the vacuum port on which the module is mounted is electrically grounded. This is essential for safety as well as proper operation. The gauge and/or case of the module must be connected to earth ground. Use a ground lug on the flange if necessary.

Overpressure:

Warning: Install suitable protective devices that will limit the level of the pressure to less than what the vacuum system can withstand. InstruTech convection gauges should not be used above 1000 Torr absolute pressure.

Safety (continued)Gases other than Nitrogen:

InstruTech gauges are calibrated for N₂. Do not attempt to use with other gases such as argon or CO₂ unless accurate conversion data for N₂ to the other gas is properly used. Refer to Appendix B for a more complete discussion of issues.

Do not use a convection gauge in an explosive atmosphere or in the presence of flammable gases or fumes.

Do not use a convection gauge to measure the pressure of explosive or combustible gases or mixtures. The sensor wire in the gauge normally operates at 125 C, but under malfunction the wire temperature could exceed the ignition temperature of combustible mixtures.

Installation

This manual describes installation of the VGC-301 Controller and connection to the vacuum gauge. For installation of the vacuum gauge, refer to the instruction manual for your particular gauge.

Installation - Controller Mounting

The VGC-301 was designed for use on a bench top, or mounted in an instrument control panel.

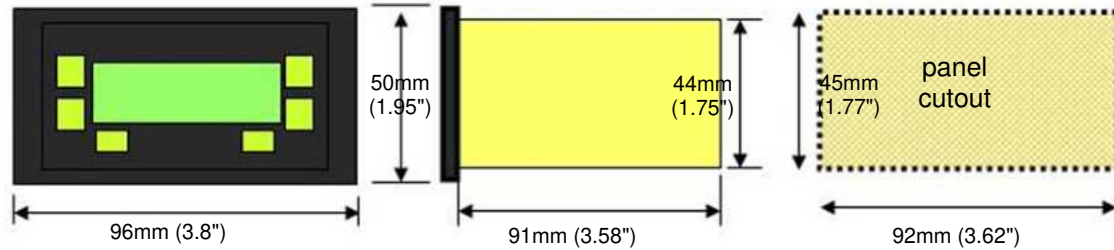

To mount the VGC-301 in a panel:

1. Make a cutout in your instrument control panel as shown in the drawing above. Be sure to allow clearance behind the panel for the instrument as well as connectors and cables at the rear of the instrument.
2. Slip a screwdriver into the slot located on either side of the front panel bezel, and pry the bezel off.
3. Slide the VGC-301 into the panel hole cutout.
4. On either side of the VGC-301 are two screw-mounting brackets. When the screws in the front of the instrument are turned counterclockwise, the hold-down brackets recess out of the way into the VGC-301 housing. When these screws are turned clockwise, the brackets rotate out 90° behind the panel. Tighten these screws until the brackets hold the VGC-301 in place against the panel.
5. Press the bezel back in place on the front of the instrument.



Installation - Electrical Connections

Grounding: Be sure the vacuum gauge and the rest of your vacuum system are properly grounded to protect personnel from shock and injury. Be aware that some vacuum fittings, especially those with O-rings, do not make a good electrical connection between the gauge and the chamber.

A good recommended practice is to remove power from any cable prior to connecting or disconnecting it.

The InstruTech VGC-301 may replace similar controllers from other manufacturers, such as BOC/Edwards, Helix/Granville-Phillips, Inficon, MKS Instruments, Varian Vacuum, and others. Many of these employ the same 9- and 15-pin D connectors, but they do not all use the same signal/pinout configurations. If you wish to use your existing cables, be sure to check compatibility with the tables below, and rewire your cables as necessary.

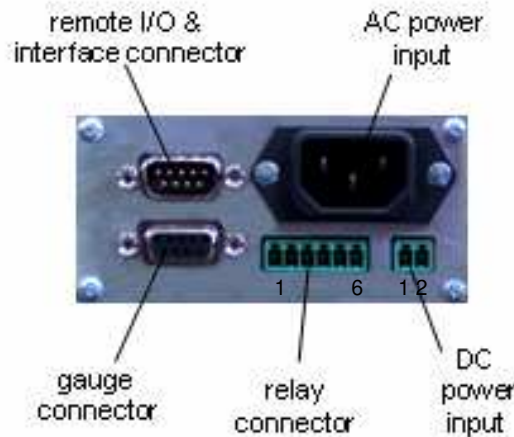

AC Power Input

Universal AC power cord input plug. The VGC-301 accepts AC power from 100 to 240 VAC, 50/60Hz. The VGC-301 includes a power cord with North America 115 VAC plug on the other end. Consult InstruTech for availability of AC cords with plugs for other countries.

DC Power Input

Two-pin pluggable terminal strip (Mating connector: Phoenix p/n 1803578 or InstruTech p/n 000327).

pin number	pin description
1	+12 to +30 V
2	ground

Note: The VGC-301 will operate from either AC or DC power. It is not necessary to supply both.

Installation - Electrical Connections (continued)

Remote I/O & Interface Connector

Nine-pin D male. (Mating connector: InstruTech p/n 000263 + 000264)

pin number	pin description
1	RS485B TX/RX
2	RS485A TX/RX
3	RS485B TX
4	RS485A TX
5	RS232 TX
6	RS232 RX
7	analog signal output (non-linear, linear, or log-linear)
8	signal ground
9	relay disable

Relay Connector

Six-pin pluggable terminal strip (Mating connector: Phoenix p/n1803617 or InstruTech p/n 000347)

pin number	pin description
1	relay 1 common
2	relay 1 NC
3	relay 1 NO
4	relay 2 common
5	relay 2 NC
6	relay 2 NO

Gauge Connector

VGC-301 - Nine-pin D female. (Mating connector: InstruTech p/n 000XXX + 000YYY)

CVG Gauge tube - Custom connector (Mating connector: InstruTech p/n 000ZZZ)

VGC-301 pin number	connects to	CVG gauge pin number
1		NC
2		cable shield
3		3
4		3
5		2
6		5
7		1
8		1
9		NC

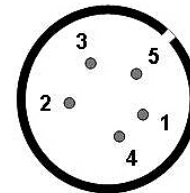

Setup and Operation

User Interface Basics:

The menus within the VGC-301 user interface have been designed for easy operation and a natural progression of setup parameters. The complete map of the user interface screens is shown in appendix A. The following sections give a brief explanation of the features for added clarity.

The four buttons to the left and right of the display are the programming buttons. During programming of the VGC-301, the display will identify what function each button represents.

To begin programming, press any of the four Programming Buttons. After setting the various parameters, press the SAVE/EXIT key to save the new setting and return to the main screen. To continue setting additional parameters, scroll forward with the MORE key until you reach the desired parameter.



Menu Item Explanations:

SET UNITS

This should be the first parameter that is set. This will be the units (Torr, mBar, or Pascal) that are used for all other settings. If the setpoints have already been set, changing units is not recommended because the setpoints will return to their default setting. [Factory default = Torr.]

SET VACUUM

Setting the Zero Point (Vacuum Adjust):

1. Evacuate the system to a pressure less than 0.1 mTorr.
2. Go to the "Set Vacuum" screen. When the pressure is below 0.1 mTorr, press the "Press to set vac" key. The zero point is now set.

SET ATM

Setting the Span Point (Atmosphere Adjust):

1. Backfill the system with Nitrogen to a known pressure above 400 Torr.
2. Go to the "Set ATM" screen. When desired system pressure is stable, adjust the pressure on the screen to the known value using the INCRease and DECRease keys on the left side of screen. Press the SAVE/EXIT key to save the new atmosphere value.

SET SP1 ON and SET SP2 ON:

These setpoints correspond to the turn on points for each relay. The relays will turn on when the pressure drops below this setting. [Factory default = 100 mTorr.]

SET SP1 OFF and SET SP2 OFF:

These setpoints correspond to the turn off points for each relay. The relays will turn off when the pressure rises above this setting. [Factory default = 200 mTorr.]

SET ADDR:

This is the lower nibble of the one byte RS485 device address. (e.g. Setting this to a 5 would make the address be 0x05 in hex; a 15 would be 0x0F in hex; if the address offset is equal to 0.) Note that Address must be used even in RS232 commands. [Factory default = 1]

SET ADDR OFFSET

This is the upper nibble of the one byte RS485 address. (e.g. Setting this to a 5 (with ADDR = 0) would make the address 0x50, a 15 would be 0xF0.) [Factory default = 0.]

SET BAUD

This sets the baud rate for the RS485 and the RS232. The baud rate can be set to many other values through the serial interface command set. The parity can also be changed. When this occurs, the current setting will be shown in the list of choices and can be re-selected if changed. [Factory default = 19.2K baud]

RS485 TYPE

Select 2-wire or 4-wire configuration for the RS-485 interface.

SET ANALOG

Selects non-linear, linear, or log-linear for the analog output.

SET LINEAR

This will take the user to 4 screens to setup the linear analog output.

- a) Set the minimum pressure,
- b) Set the minimum voltage corresponding to the minimum pressure.
- c) Set the maximum pressure.
- d) Set the maximum voltage corresponding to the maximum pressure.

The linear output voltage can be any values between 10mV and 10V corresponding to pressure values between 1 mTorr and 1000 Torr. [Factory default is 10mV to 10 Vdc corresponding to 1 mTorr to 1 Torr.]

INFO

This screen shows the Instrutech phone number for questions and the unit software version.

Calibration:

All InstruTech gauges are calibrated prior to shipment using Nitrogen. However, you can calibrate the VGC-301 against your own standards, using the zero and span settings, as described above. Zero and span affect the displayed pressure values and the output signals. Care should be exercised when using gases other than nitrogen N₂ - See Appendix B for more information.

Interface

RS485/RS232 Command Protocol Summary

Note: This protocol was designed to be 100% compatible with the Helix / Granville-Phillips Mini-Convectron®.

COMMAND	BRIEF DESCRIPTION	COMMAND SYNTAX	RESPONSE
READ	Read the current pressure in Torr	#xxRD<CR> (eg: #01RD<CR>)	*xx_y.yyEzyy<CR> (eg: *01_7.60E+02<CR>)
SET ADDR OFFSET	Set the communications (RS485) address offset (upper nibble) *	#xxSAxx<CR> (eg: #01SA04<CR>)	*xx_PROGM_OK<CR>
SET SPAN	Set the span or atmosphere calibration point	#xxTSy.yyEzyy<CR> (eg: #01TS7.60E+02)	*xx_PROGM_OK<CR>
SET ZERO	Set the zero or vacuum calibration point	#xxTZ0<CR> (eg: #01TZ0<CR>)	*xx_PROGM_OK<CR>
SET TRIP POINT #1	Set the 'turns on below' pressure point for relay #1 and set the 'turns off above' pressure point for relay #1.	#xxSLzy.yyEzyy<CR> (eg: #01SL+4.00E+02<CR>) (eg: #01SL-5.00E+02<CR>)	*xx_PROGM_OK<CR>
SET TRIP POINT #2	Set the 'turns on below' pressure point for relay #2 and set the 'turns off above' pressure point for relay #2.	#xxSHzy.yyEzyy<CR> (eg: #01SH+4.00E+02<CR>) (eg: #01SH+5.00E+02<CR>)	*xx_PROGM_OK<CR>
READ TRIP POINT #1	Read the 'turns on below' pressure point for relay #1 and read the 'turns off above' pressure point for relay #1.	#xxRLz<CR> (eg: #01RL+<CR>) (eg: #01RL-<CR>)	*xx_y.yyEzyy<CR> (eg: *01_7.60E+02<CR>)
READ TRIP POINT #2	Read the 'turns on below' pressure point for relay #2 and read the 'turns off above' pressure point for relay #2.	#xxRHz<CR> (eg: #01RH+<CR>) (eg: #01RH-<CR>)	*xx_y.yyEzyy<CR> (eg: *01_7.60E+02<CR>)
READ SW VERSION	Read the revision number of the firmware.	#xxVER<CR> (eg: #01VER<CR>)	*xx_mmnnv-vv (eg: *0105041-00)
SET FACTORY DEFAULTS	Force unit to return ALL settings back to the way the factory programmed them before shipment.	#xxFAC<CR> (eg: #01FAC<CR>)	*xx_PROGM_OK<CR>
SET BAUD RATE	Set the communications baud rate for RS485 and RS232.*	#xxSByyyyy<CR> (eg: #01SB19200<CR>)	*xx_PROGM_OK<CR>
SET NO PARITY	Set the communications to NO parity, 8 bits for the RS485 and RS232.*	#xxSPN<CR> (eg: #01SPN<CR>)	*xx_PROGM_OK<CR>
SET ODD PARITY	Set the communications to ODD parity, 7 bits for the RS485 and RS232.*	#xxSPO<CR> (eg: #01SPO<CR>)	*xx_PROGM_OK<CR>
SET EVEN PARITY	Set the communications to EVEN parity, 7 bits for the RS485/ RS232.*	#xxSPE<CR> (eg: #01SPE<CR>)	*xx_PROGM_OK<CR>
RESET	Reset the device as if power was cycled. (required to complete some of the commands.)	#xxRST<CR> (eg: #01RST<CR>)	No response

* Commands marked with an asterisk will not take effect until after RESET command is sent or power is cycled.

NOTES:

1. All Responses are 13 characters long.
2. xx is the address of the device. (00 thru FF)
3. <CR> is a carriage return.
4. _ is a space.
5. The 'z' in the set or read trip point commands is a + or -. The plus is the 'turns on below' point and the minus is the 'turns off above' point.
6. All commands sent to the module start with a '#' character, and all responses from the module start with a '*' character.
7. This protocol was designed to be 100% compatible with the Helix Mini-Convectron®.
8. A valid address must be used even in RS232 commands. Factory default is 1.

Service

Maintenance

Under normal circumstances, there is no routine maintenance required for your VGC-301 Controller. Good manufacturing practice suggests that all measuring instruments should be periodically calibrated against known calibration standards.

Cleaning

The most common cause of all vacuum gauge failures is contamination of the sensor. Refer to the instruction manual for your gauge for more information. Appendix C also contains a more complete discussion of contamination and cleaning procedures.

Troubleshooting

<i>Indication</i>	<i>Possible Cause</i>	<i>Possible Solution</i>
Display is off / blank	No power	Check cable connections and verify that power is being supplied.
Display reads "Sensor Bad"	The gauge tube or gauge cable is disconnected. The gauge tube is bad.	Check gauge cable connections. Replace gauge tube.
Readings appear very different from expected pressure	The process gas is different from the gas used to calibrate the gauge. The gauge and VGC-301 have not been calibrated or have been calibrated incorrectly	Correct readings for different gas thermal conductivity. See Appendix B. Check that zero and atm are adjusted correctly.
Readings are noisy or erratic	Loose cables or connections Contamination	Check and tighten connections. Inspect gauge for signs of contamination such as particles, deposits, or discoloration on gauge inlet. Try cleaning if appropriate.
Gauge cannot be calibrated - zero and span (vacuum & atm)	Contamination. Sensor failure for other cause.	Replace or clean the gauge. See Appendix C on cleaning. Replace gauge.
Setpoint does not actuate	Incorrect setup	Check setpoint setup

Factory Default Reset

When all else fails, the VGC-301 can be returned to the original factory settings by pressing the upper left and upper right softkeys simultaneously. The user will then be prompted “Set Factory Defaults?”. Choose Yes or No.

Factory Service and Support

If you need help setting up, operating, or troubleshooting your controller, you are welcome to call us during normal business hours (8:00am to 5:00pm Mountain time) Monday through Friday, at 303-651-0551. Or e-mail us at info@instrutechinc.com.

If it becomes necessary to return the controller to InstruTech for service or calibration, please call or e-mail us for a return authorization. For the safety of our employees, if you are returning a gauge with the controller, you must provide a history of the gauge detailing what gases have been used. We cannot work on gauges that have been exposed to hazardous materials.

Trademarks & Acknowledgements

These trademarks, used throughout this manual, are the property of the following companies:

Convectron® and Mini-Convectron® are registered trademarks of Helix Technology Corp.

Conflat® and Mini-Conflat® are registered trademarks of Varian Vacuum Technology.

Cajon® and VCR® are registered trademarks of the Swagelok Company.

Teflon® is a registered trademark of DuPont.

Appendices

- A. User Interface Map
- B. Using Thermal Vacuum Gauges with Different Gases
- C. Vacuum Gauge Contamination and Cleaning

User Interface Map - page 2

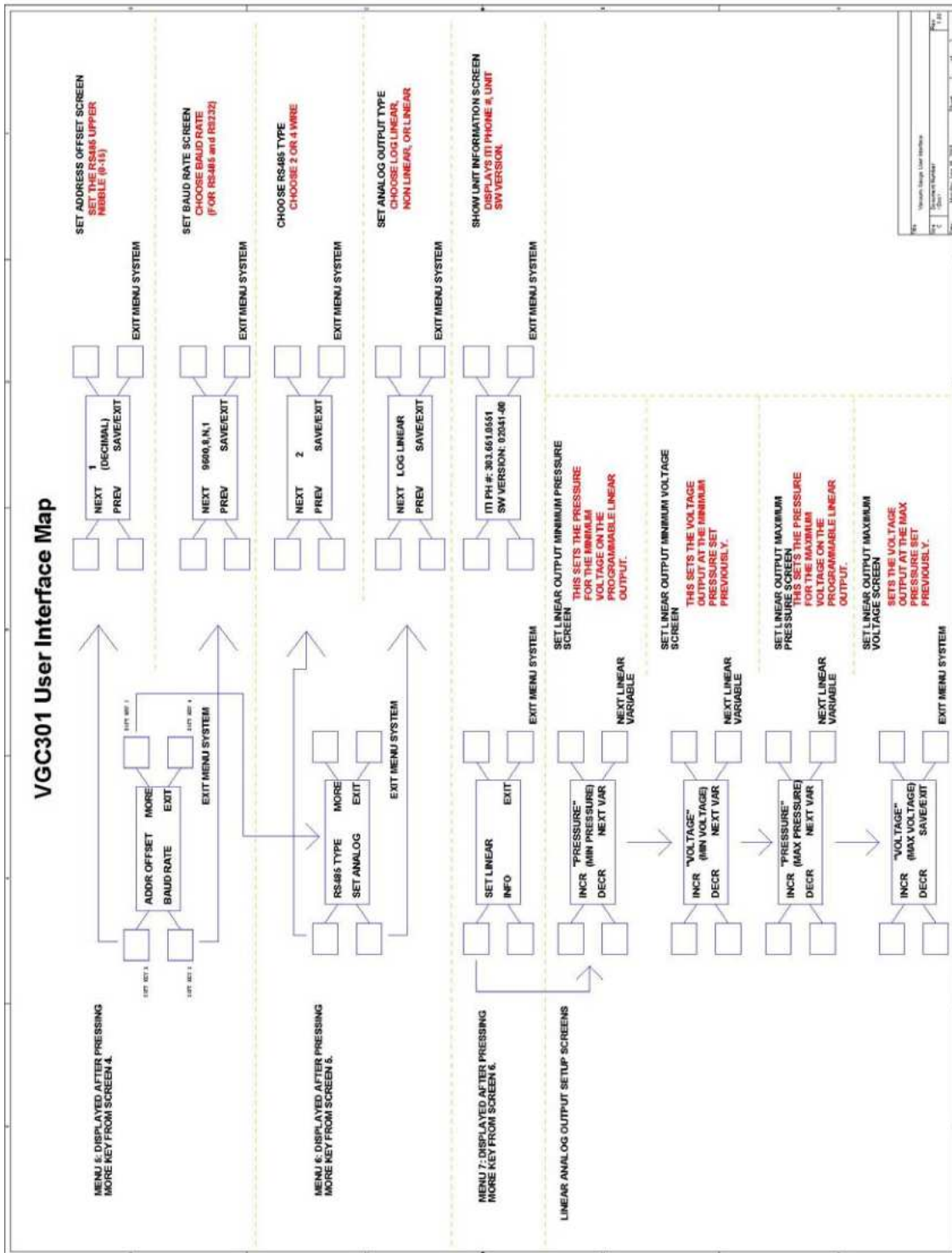

Appendix B: Using thermal vacuum gauges with different gases

Principal of Operation

Thermal conductivity gauges measure pressure indirectly, by sensing the loss of heat from a sensor to the surrounding gases. The higher the pressure of the surrounding gas, the more heat is conducted away from the sensor. Pirani thermal conductivity gauges maintain a sensor (usually a wire) at some constant temperature, and measure the current or power required to maintain that temperature. A standard Pirani gauge has a useful measuring range of about 10^{-4} Torr to 10 Torr. By taking advantage of convection currents that are generated above 1 Torr, *convection-enhanced* Pirani gauges increase the measuring range to just above atmosphere.

Output Signals and Displays

A vacuum gauge sensor, by itself, does not generate any output signal or readout. Electronic signal conditioning is required to convert heat loss into a useable signal and/or readout of pressure. Note that the output signal voltage is not the same as the displayed pressure readings. Table 3 below shows the displayed readings at various pressures for selected gases.

Non-Linear Output

Granville-Phillips' first Convectron[®] gauge controllers produced a non-linear output signal of 0.375 to 5.659 VDC for 0 to 1000 Torr of N₂, roughly in the shape of an "S" curve, as shown at right. GP adopted the same output curve for most of their Mini-Convectron[®] modules and controllers with non-linear output (though in recent years, some GP controllers produced a different S-curve).

The non-linear output from InstruTech convection gauges, modules, and controllers duplicates exactly the original S-curve of 0.375 to 5.659 VDC for 0 to 1000 Torr.

Table 1 below contains the lookup data for converting the non-linear output voltage into pressure values.

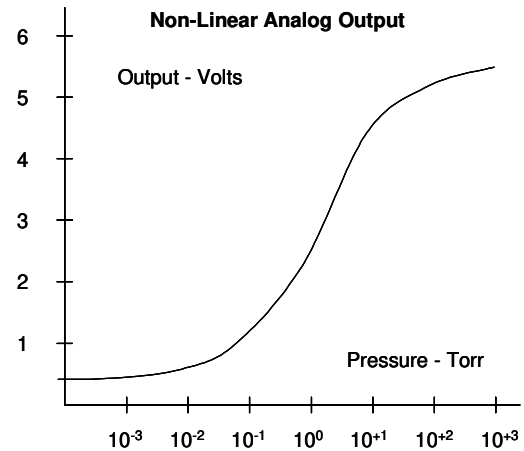

Log-Linear Output

Many InstruTech modules and controllers also provide a log-linear output signal, as an alternative to the non-linear signal described above. This output, shown at right, is a 1 Volt per decade signal that may be easier to use for data logging or control.

Table 2 below contains the lookup data and provides the formulas for converting the log-linear output voltage into pressure values.

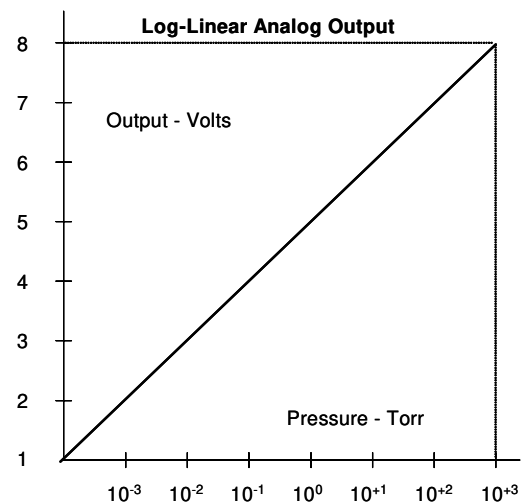

Linear Output

Some InstruTech controllers & modules offer a user-programmable linear analog output. In this case, the user chooses the two end points, and the signal is a linear output voltage between those two points.

A couple of examples are shown at right:

Example-A: A full scale of 10 Volts was chosen to equal 1 Torr, and 10 mVolts was chosen to equal "zero" pressure (considered here to be 10^{-4} Torr). [Note: These are the factory default settings, which also happen to be the same as the Granville-Phillips linear output.]

Example-B: In this case, a full scale of 5 Volts equals 100 mTorr and 1 Volt equals 10 mTorr.

Because you can choose virtually any zero and span settings, there are an infinite number of possible linear signal configurations. If needed, you must generate your own table of signal vs pressure values for your particular setup.

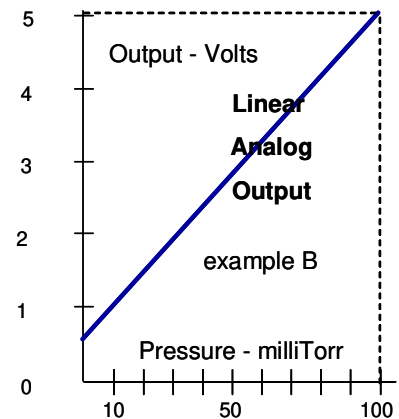
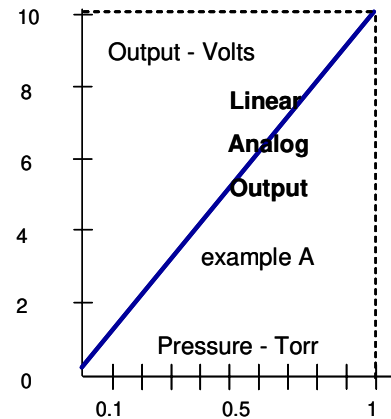

Some considerations in choosing the best analog signal to work with:

1. The non-linear S-curve is convenient if you are replacing a Convectron[®] which has that output, and you don't want to change anything in the control system. For new systems, however, the formulas needed to interpret the non-linear signal are complex and difficult to use. The linear or log-linear signal is generally easier to interface with today's data acquisition or control systems.
2. The linear signal is good when you want to monitor pressure over a limited range of 1 or 2 decades. If you try to use the linear signal over too wide a range, the signal at the low end of pressures will be too small to be useable by most electronic systems. For example: If you tried to setup the linear signal to cover the range from 1000 to 10^{-3} Torr, the signal at 10^{-3} Torr would be 1 microVolt. For most systems, that level of signal would be lost in the noise and you could never see it. For this reason, and to distinguish a valid low pressure reading from a power-loss/off/fail condition, the minimum linear signal cannot be set lower than 10 milliVolts.
3. If you need to monitor pressure over a wider range, you should use the log-linear signal. This output covers the entire measuring range with a high level 1 to 8 Volt signal. The signal changes by 1 Volt for each decade, and, even at the very low end, the smallest signal is still milliVolts, not microVolts. Also, the formulas defining the relationship between Voltage and pressure are simple and can be readily programmed into most computers / data acquisition systems.

The discussions above, about signals, assumed the gas being measured is Nitrogen. The following discussion illustrates how other gases affect both readings and outputs from thermal vacuum gauges.

Effect of Different Gases on Signals and Displayed Pressure

A thermal conductivity gauge senses heat loss, which depends on the thermal conductivity of the gas surrounding the sensor. Since different gases, and mixtures, have different thermal conductivities, the indicated pressure readings and outputs will also be different. InstruTech convection gauges (and most other thermal gauges) are normally calibrated using nitrogen. When a gas other than N₂ is used, correction must be made for the difference in thermal conductivity, between N₂ and the gas in use. The charts and tables below indicate how different gases affect the display and output from an InstruTech convection gauge.

For N₂ the calibration shows excellent agreement between indicated and true pressure throughout the range from 10⁻⁴ to 1000 Torr. (As it *should*, of course, since they're calibrated for N₂.) At pressures below 1 Torr, the calibration curves for the different gases are similar: the difference in readings at these low pressures is a constant, a function of the difference between thermal conductivities of the gases.

At pressures above 1 Torr, indicated pressure readings may diverge significantly. At these higher pressures, convection currents in the gauge become the predominant cause of heat loss from the sensor, and calibration depends on gauge tube geometry and mounting position, as well as gas properties.

Generally, air and N₂ are considered the same as far as thermal conductivity goes, but even these two gases will exhibit slight differences in readings at higher pressures. For example, when venting a system to atmosphere using N₂, you may see readings change by 30 to 40 Torr after the chamber is opened and air gradually displaces the N₂ in the gauge.

For most other gases, the effect is much more significant, and may result in a hazardous condition, as described below.

Other considerations when using gases other than N₂

Flammable or explosive gases:

InstruTech CV gauges and modules are not intrinsically safe or explosion proof, and are not intended for the measurement, or use in the presence, of flammable or explosive gases or vapors.

Under normal conditions, the voltages and currents in InstruTech CV Gauges and Modules are too low to cause ignition of flammable gases. However, under certain failure conditions, sufficient energy could be generated to cause flammable vapors or gases to ignite or explode.

Thermal gauges like the InstruTech CV gauges and modules are not recommended for use with flammable or explosive gases.

Moisture / water vapor:

In some processes (lyophilization, for example). the gas composition may not change significantly, except for moisture content. Water vapor can significantly change the response of a thermal gauge and correction should be made, as you would for any other gas.

Other contaminants:

If your gases condense, coat, or corrode the sensor, the gauge calibration and response to different gases will change. Generally, if the gauge can be "calibrated" ("zero" and "atmosphere" settings), these changes are small enough to be ignored. If you cannot set zero and atmosphere, the gauge should be replaced or cleaned. (See the Application Note on cleaning for more information.)

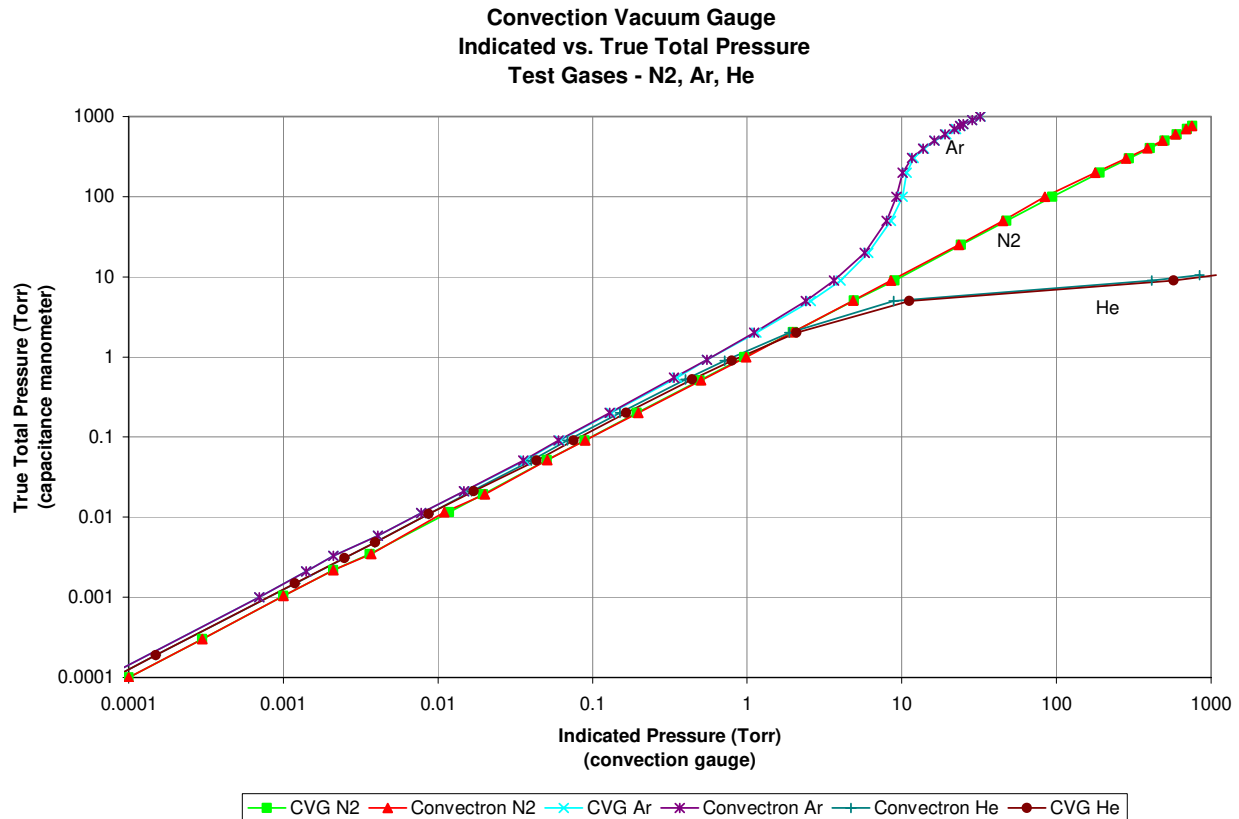

Gas Correction Chart

The Y- Axis is actual pressure, measured by a capacitance manometer, a diaphragm gauge that measures true total pressure, independent of gas composition.

The X-Axis is the pressure reading indicated by the convection gauge under test.

The chart shows readings for an InstruTech CVG as well as for a GP Convector[®] gauge, to illustrate that the response of the gauges to these different gases is virtually indistinguishable. (Caution: Do not assume this data applies to other convection gauges, which may or may not be the same.)

If the gas is N₂, when the true total pressure is 100 Torr, the gauge will read 100 Torr

If the gas is Ar, when the true pressure is 100 Torr, the gauge will read only 10 Torr.

If you are backfilling your vacuum system with Ar, when your system reaches atmospheric pressure of 760 Torr true pressure, your gauge will be reading about 20 Torr. If you continue to backfill your system, attempting to increase the reading up to 760, you will overpressure your chamber and probably blow up your vacuum system !

If the gas is He, the gauge will read 1000 Torr when pressure reaches about 10 Torr actual pressure.

You probably won't blow up the vacuum system, but opening the chamber to atmosphere prematurely may present other hazards for both people and product.

What these examples illustrate is that, without proper precautions,

use of different gases can result in injury to personal and/or damage to equipment.

Suggested precautions when using gases other than N₂:

Install a pressure relief valve, or burst disk, on your chamber, to protect it from overpressure.

Post a warning label on your gauge readout "Do Not Exceed ____ Torr Indicated Pressure" (fill in the blank for your gas) so that an operator using the gauge will not exceed a safe pressure.

Table 1 - Non-Linear Analog Output Voltage vs Pressure, for Selected Gases

True Total Pressure	N2	Ar	He	O2	CO2	Kr	Freon12	Freon22	D2	Ne	CH4
0 mTorr	0.3751	0.3750	0.3750	0.3750	0.3750	0.3750	0.3750	0.3750	0.3750	0.3750	0.3750
0.1 mTorr	0.3759	0.3757	0.3755	0.3760	0.3760	0.3755	0.3760	0.3760	0.3760	0.3757	0.3766
0.2 mTorr	0.3768	0.3760	0.3765	0.3770	0.3770	0.3768	0.3780	0.3780	0.3770	0.3763	0.3780
0.5 mTorr	0.3795	0.3780	0.3790	0.3800	0.3810	0.3772	0.3820	0.3810	0.3810	0.3782	0.3825
1 mTorr	0.3840	0.3810	0.3820	0.3840	0.3850	0.3790	0.3880	0.3880	0.3860	0.3810	0.3896
2 mTorr	0.3927	0.3870	0.3890	0.3920	0.3950	0.3840	0.4010	0.4000	0.3960	0.3880	0.4030
5 mTorr	0.4174	0.4030	0.4090	0.4170	0.4120	0.3950	0.4370	0.4320	0.4250	0.4050	0.4380
10 mTorr	0.4555	0.4290	0.4410	0.4530	0.4620	0.4150	0.4880	0.4800	0.4700	0.4330	0.4920
20 mTorr	0.5226	0.4770	0.4970	0.5210	0.5360	0.4510	0.5810	0.5660	0.5490	0.4840	0.5840
50 mTorr	0.6819	0.5950	0.6370	0.6790	0.7050	0.5440	0.7780	0.7640	0.7270	0.6080	0.7960
100 mTorr	0.8780	0.7450	0.8140	0.8680	0.9000	0.6680	1.0090	0.9900	0.9440	0.7680	1.0530
200 mTorr	1.1552	0.9620	1.0680	1.1410	1.1790	0.8470	1.3150	1.2910	1.2650	1.0020	1.3920
500 mTorr	1.6833	1.3860	1.5890	1.6640	1.6680	1.1940	1.8260	1.8050	1.9140	1.4690	2.0140
1 Torr	2.2168	1.8180	2.1640	2.1950	2.1720	1.5360	2.2570	2.2470	2.6030	1.9760	2.6320
2 Torr	2.8418	2.3330	2.9390	2.8140	2.6950	1.9210	2.6470	2.6660	3.5080	2.6310	3.3130
5 Torr	3.6753	3.0280	4.3870	3.6720	3.3160	2.4290	3.0290	3.0900	5.0590	3.7150	
10 Torr	4.2056	3.4800	5.7740	4.2250	3.6700	2.7340	3.2040	3.3300	6.3610	4.6050	4.6990
20 Torr	4.5766	3.8010	7.3140	4.6200	3.9030	2.9660	3.3080	3.4140		5.4060	5.1720
50 Torr	4.8464	4.0370		4.9160	4.0710	3.0750	3.4300	3.5090		6.1590	5.5830
100 Torr	4.9449	4.1220		5.0260	4.1540	3.1340	3.6180	3.6600		6.4830	5.7200
200 Torr	5.0190	4.1920		5.1060	4.3360	3.2690	3.8270	3.8830		6.6610	5.8600
300 Torr	5.1111	4.2830		5.2000	4.5020	3.3840	3.9380	4.0050		6.7260	
400 Torr	5.2236	4.3860		5.3150	4.6210	3.4660	4.0160	4.0880		6.7670	6.1030
500 Torr	5.3294	4.4770		5.4220	4.7080	3.5260	4.0760	4.1510		6.8030	
600 Torr	5.4194	4.5500		5.5150	4.7750	3.5730	4.1240	4.2030		6.8430	6.3420
700 Torr	5.4949	4.6110		5.5920	4.8300	3.6130	4.1660	4.2470		6.8900	
760 Torr	5.5340	4.6430		5.6330	4.8600	3.6320	4.1900	4.2710		6.9200	
800 Torr	5.5581	4.6630		5.6580	4.8770	3.6450	4.2030	4.2860		6.9420	6.5190
900 Torr	5.6141	4.7060		5.7130	4.9190	3.6740	4.2370	4.3210		7.0000	
1000 Torr	5.6593	4.7450		5.7620	4.9550	3.6900	4.2700	4.3540		7.0560	6.6420

Note: By design, these values are identical to the outputs from Helix/Granville-Phillips Convector[®] gauges, Mini-Convector[®] modules, and Controllers, so that equivalent units can be interchanged without affecting your process system or software.

Table 2 - Log-Linear Analog Output Voltage vs Pressure, for Selected Gases

True Pressure (Torr)	N2	Ar	He	O2	CO2	Kr	Freon12	Freon22	D2	Ne	CH4
0.0001	1.000	1.000	1.000	1.000	1.000	1.000	1.000	1.000	1.000	1.000	1.000
0.0002	1.301	1.301	1.301	1.301	1.301	1.301	1.301	1.301	1.301	1.301	1.301
0.0005	1.699	1.699	1.699	1.699	1.699	1.477	1.699	1.699	1.699	1.699	1.699
0.0010	2.000	1.845	1.903	2.000	2.041	1.602	2.176	2.176	2.114	1.845	2.230
0.0020	2.301	2.146	2.204	2.301	2.362	2.000	2.491	2.491	2.380	2.176	2.519
0.0050	2.699	2.519	2.602	2.699	2.643	2.362	2.881	2.845	2.778	2.544	2.886
0.0100	3.000	2.820	2.908	2.987	3.041	2.681	3.167	3.130	3.083	2.851	3.185
0.0200	3.301	3.117	3.207	3.297	3.346	2.978	3.476	3.435	3.386	3.149	3.483
0.0500	3.699	3.511	3.607	3.692	3.740	3.371	3.860	3.839	3.778	3.542	3.888
0.1000	4.000	3.808	3.914	3.988	4.029	3.670	4.155	4.134	4.083	3.845	4.201
0.2000	4.301	4.100	4.217	4.288	4.322	3.960	4.439	4.418	4.398	4.149	4.498
0.5000	4.699	4.494	4.638	4.687	4.689	4.336	4.786	4.774	4.837	4.555	4.893
1.0000	5.000	4.778	4.973	4.987	4.978	4.602	5.021	5.017	5.190	4.872	5.204
2.0000	5.301	5.057	5.346	5.288	5.233	4.845	5.210	5.220	5.616	5.201	5.522
5.0000	5.699	5.389	6.130	5.697	5.524	5.107	5.389	5.418	7.391	5.719	5.877
10.0000	6.000	5.602	8.041	6.013	5.696	5.250	5.471	5.530	8.041	6.332	6.446
20.0000	6.301	5.763	8.041	6.348	5.819	5.360	5.521	5.571	8.041	7.766	7.550
50.0000	6.699	5.895	8.041	6.890	5.915	5.410	5.579	5.617	8.041	8.041	7.925
100.0000	7.000	5.946	8.041	7.320	5.966	5.438	5.670	5.691	8.041	8.041	8.041
200.0000	7.301	5.991	8.041	7.470	6.090	5.521	5.777	5.808	8.041	8.041	8.041
300.0000	7.477	6.053	8.041	7.580	6.228	5.555	5.838	5.876	8.041	8.041	8.041
400.0000	7.602	6.130	8.041	7.686	6.350	5.595	5.883	5.925	8.041	8.041	8.041
500.0000	7.699	6.207	8.041	7.781	6.458	5.624	5.918	5.964	8.041	8.041	8.041
600.0000	7.778	6.274	8.041	7.863	6.561	5.647	5.947	5.998	8.041	8.041	8.041
700.0000	7.845	6.338	8.041	7.934	6.664	5.667	5.974	6.029	8.041	8.041	8.041
760.0000	7.881	6.375	8.041	7.974	6.732	5.677	5.989	6.045	8.041	8.041	8.041
800.0000	7.903	6.400	8.041	7.999	6.774	5.685	5.998	6.057	8.041	8.041	8.041
900.0000	7.954	6.455	8.041	8.041	6.900	5.698	6.021	6.079	8.041	8.041	8.041
1000.0000	8.000	6.512	8.041	8.041	7.045	5.706	6.045	6.104	8.041	8.041	8.041

The log-linear output signal and pressure are related by the following formulas:

$$P = 10^{(V - 5)} \quad V = \log_{10}(P) + 5$$

where P is the pressure in Torr, and V is the output signal in Volts.

The chart on the following page shows the graphical results of the table and formulas above. Pressure is plotted on the X-axis with a log scale; the output signal is plotted on the Y-axis on a linear scale.

Log-Linear Analog Output Voltage vs Pressure

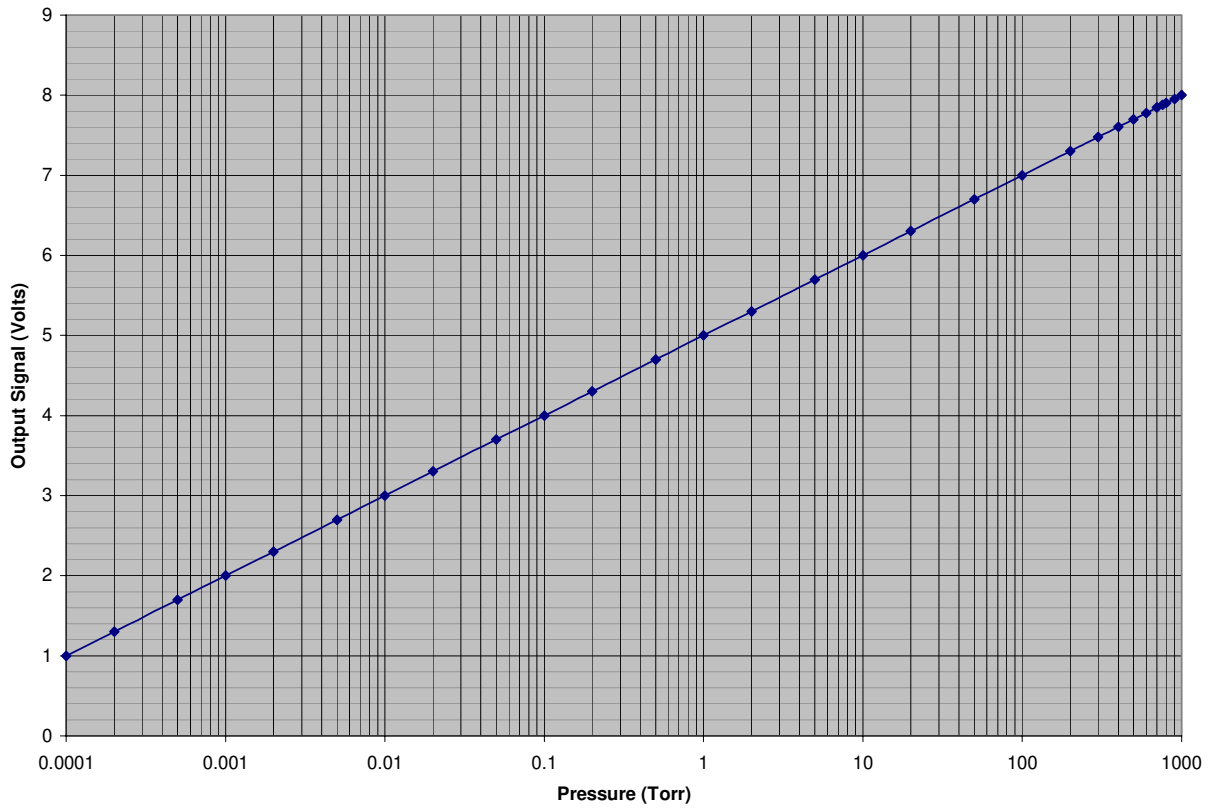

This is a plot of the formulas and data for the log-linear output signal, from the previous page.

Table 3 - Displayed Pressure Readings vs Pressure, for Selected Gases

True Total Pressure	N2	Ar	He	O2	CO2	Kr	Freon12	Freon22	D2	Ne	CH4
<i>0 mTorr</i>	<i>0.0</i>	<i>0.0</i>	<i>0.0</i>	<i>0.0</i>	<i>0.0</i>	<i>0.0</i>	<i>0.0</i>	<i>0.0</i>	<i>0.0</i>	<i>0.0</i>	<i>0.0</i>
0.1 mTorr	0.1	0.1	0.1	0.1	0.1	0.1	0.1	0.1	0.1	0.1	0.1
<i>0.2 mTorr</i>	<i>0.2</i>	<i>0.2</i>	<i>0.2</i>	<i>0.2</i>	<i>0.2</i>	<i>0.2</i>	<i>0.2</i>	<i>0.2</i>	<i>0.2</i>	<i>0.2</i>	<i>0.2</i>
<i>0.5 mTorr</i>	<i>0.5</i>	<i>0.5</i>	<i>0.5</i>	<i>0.5</i>	<i>0.5</i>	<i>0.3</i>	<i>0.5</i>	<i>0.5</i>	<i>0.5</i>	<i>0.5</i>	<i>0.5</i>
1 mTorr	1.0	0.7	0.8	1.0	1.1	0.4	1.5	1.5	1.3	0.7	1.7
<i>2 mTorr</i>	<i>2.0</i>	<i>1.4</i>	<i>1.6</i>	<i>2.0</i>	<i>2.3</i>	<i>1.0</i>	<i>3.1</i>	<i>3.1</i>	<i>2.4</i>	<i>1.5</i>	<i>3.3</i>
<i>5 mTorr</i>	<i>5.0</i>	<i>3.3</i>	<i>4.0</i>	<i>5.0</i>	<i>4.4</i>	<i>2.3</i>	<i>7.6</i>	<i>7.0</i>	<i>6.0</i>	<i>3.5</i>	<i>7.7</i>
10 mTorr	10.0	6.6	8.1	9.7	11.0	4.8	14.7	13.5	12.1	7.1	15.3
<i>20 mTorr</i>	<i>20.0</i>	<i>13.1</i>	<i>16.1</i>	<i>19.8</i>	<i>22.2</i>	<i>9.5</i>	<i>29.9</i>	<i>27.2</i>	<i>24.3</i>	<i>14.1</i>	<i>30.4</i>
<i>50 mTorr</i>	<i>50.0</i>	<i>32.4</i>	<i>40.5</i>	<i>49.2</i>	<i>54.9</i>	<i>23.5</i>	<i>72.5</i>	<i>69.0</i>	<i>60.0</i>	<i>34.8</i>	<i>77.2</i>
100 mTorr	100	64.3	82.0	97.2	107	46.8	143	136	121	70.0	159
<i>200 mTorr</i>	<i>200</i>	<i>126</i>	<i>165</i>	<i>194</i>	<i>210</i>	<i>91.1</i>	<i>275</i>	<i>262</i>	<i>250</i>	<i>141</i>	<i>315</i>
<i>500 mTorr</i>	<i>500</i>	<i>312</i>	<i>435</i>	<i>486</i>	<i>489</i>	<i>217</i>	<i>611</i>	<i>594</i>	<i>687</i>	<i>359</i>	<i>781</i>
1 Torr	1.00	600	940	970	950	400	1.05	1.04	1.55	745	1.60
<i>2 Torr</i>	<i>2.00</i>	<i>1.14</i>	<i>2.22</i>	<i>1.94</i>	<i>1.71</i>	<i>700</i>	<i>1.62</i>	<i>1.66</i>	<i>4.13</i>	<i>1.59</i>	<i>3.33</i>
<i>5 Torr</i>	<i>5.00</i>	<i>2.45</i>	<i>13.5</i>	<i>4.98</i>	<i>3.34</i>	<i>1.28</i>	<i>2.45</i>	<i>2.62</i>	<i>246</i>	<i>5.24</i>	<i>7.53</i>
10 Torr	10.0	4.00	OP	10.3	4.97	1.78	2.96	3.39	OP	21.5	27.9
<i>20 Torr</i>	<i>20.0</i>	<i>5.80</i>	<i>OP</i>	<i>22.3</i>	<i>6.59</i>	<i>2.29</i>	<i>3.32</i>	<i>3.72</i>	<i>OP</i>	<i>584</i>	<i>355</i>
<i>50 Torr</i>	<i>50.0</i>	<i>7.85</i>	<i>OP</i>	<i>77.6</i>	<i>8.22</i>	<i>2.57</i>	<i>3.79</i>	<i>4.14</i>	<i>OP</i>	<i>OP</i>	<i>842</i>
100 Torr	100	8.83	OP	209	9.25	2.74	4.68	4.91	OP	OP	OP
<i>200 Torr</i>	<i>200</i>	<i>9.79</i>	<i>OP</i>	<i>295</i>	<i>12.3</i>	<i>3.32</i>	<i>5.99</i>	<i>6.42</i>	<i>OP</i>	<i>OP</i>	<i>OP</i>
<i>300 Torr</i>	<i>300</i>	<i>11.3</i>	<i>OP</i>	<i>380</i>	<i>16.9</i>	<i>3.59</i>	<i>6.89</i>	<i>7.52</i>	<i>OP</i>	<i>OP</i>	<i>OP</i>
<i>400 Torr</i>	<i>400</i>	<i>13.5</i>	<i>OP</i>	<i>485</i>	<i>22.4</i>	<i>3.94</i>	<i>7.63</i>	<i>8.42</i>	<i>OP</i>	<i>OP</i>	<i>OP</i>
<i>500 Torr</i>	<i>500</i>	<i>16.1</i>	<i>OP</i>	<i>604</i>	<i>28.7</i>	<i>4.21</i>	<i>8.28</i>	<i>9.21</i>	<i>OP</i>	<i>OP</i>	<i>OP</i>
<i>600 Torr</i>	<i>600</i>	<i>18.8</i>	<i>OP</i>	<i>730</i>	<i>36.4</i>	<i>4.44</i>	<i>8.86</i>	<i>9.95</i>	<i>OP</i>	<i>OP</i>	<i>OP</i>
<i>700 Torr</i>	<i>700</i>	<i>21.8</i>	<i>OP</i>	<i>859</i>	<i>46.1</i>	<i>4.65</i>	<i>9.42</i>	<i>10.7</i>	<i>OP</i>	<i>OP</i>	<i>OP</i>
<i>760 Torr</i>	<i>760</i>	<i>23.7</i>	<i>OP</i>	<i>941</i>	<i>53.9</i>	<i>4.75</i>	<i>9.76</i>	<i>11.1</i>	<i>OP</i>	<i>OP</i>	<i>OP</i>
<i>800 Torr</i>	<i>800</i>	<i>25.1</i>	<i>OP</i>	<i>997</i>	<i>59.4</i>	<i>4.84</i>	<i>9.95</i>	<i>11.4</i>	<i>OP</i>	<i>OP</i>	<i>OP</i>
<i>900 Torr</i>	<i>900</i>	<i>28.5</i>	<i>OP</i>	<i>OP</i>	<i>79.5</i>	<i>4.99</i>	<i>10.5</i>	<i>12.0</i>	<i>OP</i>	<i>OP</i>	<i>OP</i>
1000 Torr	1000	32.5	OP	OP	111	5.08	11.1	12.7	OP	OP	OP

Notes:

- 1) OP = overpressure
- 2) Display auto-ranges between Torr and mTorr at 1Torr
 Readings in normal font are in Torr. *Readings in blue italics are in mTorr.*

Appendix C: *Vacuum gauge contamination and cleaning*

The most common cause of all vacuum gauge failures is contamination of the sensor. Noisy or erratic readings, the inability to set zero or atmosphere, and total gauge failure, are all possible indications of gauge contamination.

Contamination can be generally characterized as either: A) a reaction of process gases with sensor elements, or B) an accumulation of material on the sensor elements. Sensors that fail due to chemical reaction are generally not salvageable. Sensors that fail due to condensation, coatings, or particles may possibly be restored by following the cleaning procedure described below.

A) Reactive Gases

If process gases react with the materials of construction of the sensor, the result is corrosion and disintegration of the sensor over time. Plasma etching and other reactive semiconductor processes are examples where this failure mode is common. In this instance, cleaning can not solve the problem, because the sensor has been destroyed; the gauge or module must be replaced.

If you experience this failure mode quickly or frequently, you should consider a different vacuum gauge for your application. Thermal vacuum gauges may be available with different sensor materials that are not as reactive with your particular process gases. Or you may consider a different type of gauge, such as a capacitance diaphragm gauge, which exposes only stainless steel or ceramic to the gases.

There is no material that is universally chemical resistant; your choice of vacuum gauge (as well as all other vacuum components) should take into consideration the potential reactions between your process gases and the materials of construction. Consider what effect water vapor will have when combined with your process gases because a finite amount of water will enter the chamber during venting to atmosphere.

B) Condensation, Coatings, and Particles

If the failure is due to an accumulation of material in the sensor, you may be able to restore your gauge or module by cleaning. Contamination may be as simple as condensed water, or as difficult as solid particles.

Condensation: Some gases (such as water vapor) can condense on sensor surfaces, forming a liquid coating that changes the rate at which heat is removed from the sensor (which changes the calibration). The sensor can often be restored simply by pumping on the gauge between process cycles. A dry N₂ purge will help speed up drying, or the gauge may be gently heated, provided temperature doesn't exceed the specified limit (150°C with cables or electronics removed).

Coatings: Some gases can condense on sensor surfaces, forming a solid coating, which again changes the rate at which heat is removed from the sensor. Some of these coatings may be removed using an appropriate solvent, following the procedure described below.

Particles: Particles generated by the process may enter the gauge during the process cycle or during the venting cycle. The result is interference with heat removal from the sensor. The cleaning procedure described below may be able to remove particles from the gauge. However, particulate contamination is the most difficult to remove as particles can become stubbornly trapped inside the gauge.

In some processes, solid particles are created during the process, throughout the chamber, including inside the gauge. Particles tend to form on cooler surfaces, such as in a gauge at room temperature. You may slow down the build-up of particles in the gauge, by keeping the gauge warm (within specified limits) during the process cycle.

More commonly, particles in the process chamber are swept into the gauge during the vent cycle. InstruTech gauges have a screen built into the gauge port, to help keep the largest particles out of the gauge. In very dirty applications, or where particles are small enough to get through the screen, an additional filter installed on the inlet may help prolong gauge life further.

C) Cleaning Procedures

Caution: Cleaning chemicals and their handling pose a variety of health, safety, and environmental issues. Protect yourself, your co-workers, and your surroundings, by using protective clothing (gloves, eyewear, etc), performing the cleaning in a well-ventilated area, and disposing of waste materials in a responsible manner.

Cleaning solvents:

To be effective, the cleaning agent should be one that is likely to remove the suspected contaminant. It must also be compatible with the gauge materials of construction. Alcohol and water are recommended cleaning solvents, as they are compatible with most vacuum systems and components, and will remove many contaminants commonly found in vacuum processes, such as pump oil. However, depending on your particular contamination, you may need to use a more aggressive solvent.

Cleaning procedure:

1. With the gauge port up, pour your cleaning solution into the gauge port until it is full. Note: The fine mesh of the port screen may not allow the solution into the gauge tube because of surface tension effects. You may need to insert a small tool into the gauge vacuum port to push the port screen slightly away from the tube wall to allow solvent into the gauge. ("Slightly away" means less than about a millimeter.) Make sure the tool is not plated with high vapor pressure material such as zinc plating.
2. Let the solution sit for a while, 10-20 minutes should be sufficient. Gentle agitation will help disperse the solution throughout the gauge, but do not shake the gauge vigorously. (While the InstruTech gauge is constructed to be rugged, it was not designed to withstand forces exerted by *liquids* in motion.)
3. With the gauge port down, pour the solution out of the gauge and leave it to drain and dry for several hours or overnight. Warming the gauge, and/or pumping on it, will speed up the drying time.
4. When you are sure the gauge is completely dry, install it on a vacuum system, apply power, and run through the calibration setup. Pump the gauge below 10^{-4} Torr and confirm that the zero/vacuum can be set. If zero is ok, raise pressure and set the atmosphere adjustment.
 - 5a. If both zero and atm can be set properly, you have successfully cleaned your gauge.
 - 5b. If zero or atm cannot be set, the gauge has been contaminated beyond recovery and must be replaced. (You can try cleaning it again, but if the first pass doesn't recover the gauge, additional cleanings are not likely to succeed.)



VACOM Vakuum Komponenten & Messtechnik GmbH
Gabelsbergerstrasse 9 ▪ 07749 Jena ▪ Germany
Tel. +49 3641 4275-0 ▪ Fax +49 3641 4275-24
info@vacom.de ▪ www.vacom.de