

Synergy™ 2

Operator's Manual





LAB Online Exhibition



Synergy™ 2
Multi-Mode Microplate Reader

Operator's Manual

© 2010
Part Number 7131000
Revision E
BioTek® Instruments, Inc.

Notices

BioTek® Instruments, Inc.
Highland Park, P.O. Box 998
Winooski, Vermont 05404-0998 USA

All Rights Reserved

© 2010, BioTek® Instruments, Incorporated. No part of this publication may be reproduced, transcribed, or transmitted in any form, or by any means electronic or mechanical, including photocopying and recording, for any purpose other than the purchaser's use without written permission of BioTek Instruments, Inc.

Trademarks

BioTek® is a registered trademark, and Synergy™ 2, Gen5™, Take3™, and BioStack™ are trademarks of BioTek Instruments, Inc. Glowell™ is a trademark of LUX Biotechnology, Ltd. Harta™ is a trademark of Harta Instruments. FluoSpheres® is a registered trademark of Invitrogen Corporation.

Microsoft®, Windows®, Windows XP, Windows 2000, and Windows Vista™ are either registered trademarks or trademarks of Microsoft Corporation in the United States and/or other countries.

All other trademarks are the property of their respective holders.

Restrictions and Liabilities

Information in this document is subject to change and does not represent a commitment by BioTek Instruments, Inc. Changes made to the information in this document will be incorporated in new editions of the publication. No responsibility is assumed by BioTek for the use or reliability of software or equipment that is not supplied by BioTek or its affiliated dealers.

Contents

Notices	2
All Rights Reserved.....	2
Trademarks.....	2
Restrictions and Liabilities	2
Contacting BioTek Instruments, Inc.	8
Customer Service and Sales	8
Service/TAC	8
European Coordination Center/Authorized European Representative	8
Revision History	9
Document Conventions	11
Intended Use Statement	11
Quality Control	11
Warranty and Product Registration	12
Warnings	12
Hazards.....	12
Precautions	13
CE Mark.....	14
Directive 89/336/EC: Electromagnetic Compatibility	14
Directive 73/23/EEC Low Voltage (Safety)	15
Directive 2002/96/EC: Waste Electrical and Electronic Equipment	15
Directive 98/79/EC: In Vitro Diagnostics.....	15
Electromagnetic Interference and Susceptibility	16
User Safety	16
Safety Symbols.....	17
Chapter 1: Introduction	19
Product Description	20
Package Contents.....	21
Optional Accessories.....	22
Product Support and Service.....	24
Technical Assistance Center (TAC)	24
Applications Support.....	24
Chapter 2: Installation	25
Product Registration	26
Important Information	26
1: Unpack and Inspect the Reader	27
2: Unpack and Inspect the Dispense Module	28
3: Select an Appropriate Location	29
4: Remove the Shipping Hardware	29
5: Install the Power Supply.....	34
6: Install the Dispense Module	35
7: Connect the Host Computer	37
8: Install Gen5 on the Host Computer	38

9: Turn on the Power Supply and Reader	38
10: Establish Communication	39
Communication Errors	39
11: Run a System Test	39
12: Test the Injector System	41
Operational/Performance Qualification.....	42
Repackaging and Shipping Instructions	43
Chapter 3: Getting Started	49
Modular Design.....	50
External Components.....	51
Internal Components	52
Tungsten Lamp	53
Description and Location	53
When to Replace the Lamp	53
Excitation/Emission Filters	54
EX/EM Configuration for Luminescence	54
Mirrors	55
Injector System	56
External Dispense Module.....	56
Internal Tubing	57
Priming the Injector System	58
Gen5 Software.....	59
Define Excitation/Emission Filters	59
Define Mirrors.....	59
Protocols and Experiments.....	60
Dispense Module Control	61
Prime	61
Purge	61
Recommendations for Optimum Performance	62
Chapter 4: Filters and Mirrors	63
Excitation/Emission Filters	64
Change the Filter Wheels and Filters	65
Clean the Filters.....	66
Filters Available from BioTek.....	67
Mirrors	68
Change the Mirror Holder and Mirrors.....	71
To remove the mirror holder	72
To change a mirror in the mirror holder	73
To reinstall the mirror holder	76
Clean the Mirrors	76
Mirrors Available from BioTek.....	77
Chapter 5: Instrument Qualification	79
Overview	80
IQ/OQ/PQ	80
Recommended Qualification Schedule	82

System Test	83
Absorbance Plate Test.....	87
Description.....	87
Test Plate Certificates	88
Define Absorbance Test Plate Parameters	88
Run the Absorbance Plate Test	89
Sample Report.....	90
Results & Troubleshooting Tips.....	91
Absorbance Liquid Tests.....	92
Absorbance Liquid Test 1.....	93
Materials.....	93
Solution A	93
Solution B	93
Prepare the Plate	94
Read the Plate	94
Analyze the Results	94
Absorbance Liquid Test 2.....	95
Materials.....	95
Prepare the Dilutions	95
Prepare the Plate	96
Linearity & Repeatability Tests	96
Alignment Test	96
Absorbance Liquid Test 3 (Optional).....	97
Materials.....	97
Buffer Solution.....	97
Prepare the Plate	98
Read the Plate	98
Analyze the Results	98
Fluorescence Liquid Tests	99
Required Materials.....	100
All Tests.....	100
Corners/Sensitivity/Linearity (FI) Tests	100
Fluorescence Polarization (FP) Test	101
Time-Resolved Fluorescence (TRF) Test.....	101
Test Solutions.....	101
Corners/Sensitivity/Linearity (FI) Tests	102
Fluorescence Polarization (FP) Test	103
Time-Resolved Fluorescence (TRF) Test.....	103
Procedure	104
Pipette Maps.....	105
Corners Test.....	105
Sensitivity and Linearity Tests.....	106
FP Test	107
TRF Test	107
Results Analysis	108

Corners Test.....	108
Sensitivity Test	108
Linearity Test.....	108
Fluorescence Polarization (FP) Test	109
Time-Resolved Fluorescence (TRF) Test.....	109
Troubleshooting Tips.....	110
Gen5 Protocol Reading Parameters	111
Fluorescence Tests Using Methylumbelliferone	114
Required Materials.....	114
Test Solutions.....	114
Procedure	115
Pipette Map	116
Results Analysis	117
Sensitivity Test	117
Linearity Test.....	117
Gen5 Protocol Reading Parameters	118
Luminescence Test.....	119
Harta Plate Test	119
Materials	119
Procedure	119
Plate Map.....	119
Results Analysis	120
Glowell Test	120
Materials.....	120
Procedure	120
Results Analysis	121
Troubleshooting	122
Gen5 Protocol Reading Parameters	122
Dispense Module Tests.....	124
Required Materials.....	124
Test Solutions.....	125
Procedure for Models <u>with</u> the Absorbance Module	126
Procedure for Models <u>without</u> the Absorbance Module	127
Results Analysis	128
Failures.....	129
Gen5 Test Protocols for Models <u>with</u> the Absorbance Module.....	129
Gen5 Test Protocols for Models <u>without</u> the Absorbance Module	131
Create the Dispense Protocols	131
Create the Read Protocol (if needed)	132
Chapter 6: Preventive Maintenance.....	137
Preventive Maintenance	138
Daily Cleaning for the Dispense Module	138
Schedule.....	139
Warnings and Precautions	139
Clean Exposed Surfaces	141

Inspect/Clean Excitation and Emission Filters	141
Inspect/Clean Mirrors	142
Materials.....	143
Procedure	143
Flush/Purge the Fluid Path.....	143
Run a Dispense Protocol (Optional).....	144
Empty/Clean the Tip Priming Trough.....	145
Clean the Priming Plate.....	145
Clean the Internal Components.....	146
Required Materials.....	146
Remove the Reader's Shroud	147
Clean the shroud's air filters	148
Remove the Internal Dispense Tubes and Injector Heads	149
Clean the Dispense Tubes and Injector Heads	152
Clean Inside the Reader	153
Remove the Incubator Housing	154
Clean the Reader's Surface.....	157
Reassemble the Components	158
Verify Performance.....	159
Chapter 7: As Needed Maintenance	161
Decontamination.....	162
Required Materials.....	163
Procedure for Models without Injectors.....	164
Procedure for Models with Injectors	165
Routine Procedure.....	165
Clean Exposed Surfaces	165
Decontaminate the Fluid Lines.....	166
Rinse the Fluid Lines.....	166
Clean the Internal Tubing and Injectors.....	167
Decontaminate the Tip Priming Trough and Priming Plate.....	167
Alternate Procedure	167
Replace the Tungsten Lamp.....	169
Replace a Syringe	171
Appendix A: Specifications	173
General Specifications.....	174
Absorbance Specifications	175
Luminescence Specifications.....	176
Fluorescence Specifications.....	177
Models with Injectors.....	179
Appendix B: Error Codes.....	181
Overview	182
Contact Info: BioTek Service/TAC.....	182
Error Codes.....	183
Appendix C: Instrument Dimensions for Robotic Interface	187

Contacting BioTek Instruments, Inc.

BioTek® Instruments, Inc.
Highland Park, P.O. Box 998
Winooski, Vermont 05404-0998 USA

Customer Service and Sales

Internet: www.biotek.com
Phone: 888-451-5171 (toll free in the U.S.)
802-655-4740 (outside the U.S.)
Fax: 802-655-7941
E-Mail: customercare@biotek.com

Service/ TAC

Phone: 800-242-4685 (toll free in the U.S.)
802-655-4740 (outside the U.S.)
Fax: 802-654-0638
E-Mail: tac@biotek.com

European Coordination Center/ Authorized European Representative

BioTek® Instruments GmbH
Kocherwaldstrasse 34
D-74177 Bad Friedrichshall
Germany

Internet: www.biotek.de
Phone: +49 (0) 7136 9680
Fax: +49 (0) 7136 968 111
E-Mail: info@biotek.de



Revision History

Revision	Date	Changes
A	08/2006	First issue.
B	12/2007	<p>General: Changed all instances of "multi-detection" to "multi-mode". Changed all instances of "filter cartridge" to "filter wheel".</p> <p>Preface: Added Glowell™ and FluoSpheres® to Trademarks. Removed Figures list.</p> <p>Ch. 1, Introduction: Updated Package Contents and Accessories lists. Added note stating that part numbers are subject to change.</p> <p>Ch. 2, Installation: Revised unpacking/repackaging instructions. Added note stating that packaging materials are subject to change.</p> <p>Ch. 3, Getting Started: Simplified Gen5 Software usage instructions.</p> <p>Ch. 4, Filters and Mirrors: Mirrors section: Added information on Visible and UV-polarizing filters. Corrected high end of EM Range for 510 nm mirror (changed 780 nm to 640 nm). Changed mirror label location from "lower left corner" to "face up and readable" and added an illustration. Updated list of dichroic mirrors available from BioTek.</p> <p>Ch. 5, Instrument Qualification: Added materials and procedure for a Luminescence Test. Fluorescence Liquid Tests section: Added option to use Greiner SensoPlate to FI tests for the top optics. Corrected instances of "505 nm" mirror to "510 nm" and "410 nm" to "400 nm". Under "Results Analysis" for the FP Test, corrected the wells used for the Mean Blank calculations—changed from A1-H6 to A6-H6. Added option to use Sodium Borate instead of PBS. Reconfigured the SF test solutions and dilutions for efficiency and consistency with other BioTek products. Added troubleshooting tip to reduce the Sensitivity value in the Gen5 protocol if well(s) are overranging during the Fluorescence Intensity tests. To minimize the opportunity for overranging during these tests, reduced the recommended Sensitivity values for the SF Fluorescence Intensity Corners and Sensitivity top probe tests to 75. Updated the materials list and solution preparation steps for the TRF test to support the use of FluoSpheres® from Invitrogen. Removed screen shots of sample BioTek data sheets. Under "Gen5 Protocol Reading Parameters" added the Sensitivity value as an example of a protocol parameter that may need to be adjusted for some readers. Added FI tests using Methylumbelliferone.</p> <p>Ch. 6, Preventive Maintenance: Removed unnecessary task to clean supply bottles.</p> <p>Ch. 7, As Needed Maintenance: Changed the replacement tungsten lamp part number to 7080500.</p> <p>Appendix B, Error Codes: Revised to focus on only the most common, most easily-fixed error codes that may appear in Gen5.</p>

Revision	Date	Changes
C	1/2010	<p><i>Throughout:</i> Added information for purchasing and using the Harta Luminometer Reference Microplate. Added support for the BioTek Take3 Multi-Volume Plate.</p> <p><i>Preface:</i> Updated the Intended Use Statement; the Synergy 2 may be used for In Vitro Diagnostic, research and development, or other non-clinical purposes. Added information for registering products online through the BioTek Customer Resource Center. Updated the list of Hazards and Precautions. Updated CE Mark information and Safety Symbols.</p> <p><i>Ch 1, Introduction:</i> Updated the list of Optional Accessories and added a reference to the BioTek online Accessories search tool. Removed the BioTek shipping address; customers will be notified of the address when they contact TAC/Service for a Return Materials Authorization number.</p> <p><i>Ch 2, Installation:</i> Combined reader unpacking/inspection and shipping panel removal instructions. Moved dispense module figures from step 2 to “Repackaging and Shipping Instructions.” Corrected USB Driver Software CD instructions under “Establish Communication”.</p> <p><i>Ch 3, Getting Started:</i> Added “Modular Design,” “External Components,” and “Internal Components.” Clarified/updated content in remaining sections.</p> <p><i>Ch 4, Filters and Mirrors:</i> Clarified instructions throughout. Added “Filters Available From BioTek.” Moved mirror cleaning instructions to Chapter 7.</p> <p><i>Ch 5, Instrument Qualification:</i> Corrected unit of measure typos. Added reference to new BioTek test kits for fluorescence liquid testing. Added Luminescence Test using the new Harta plate. Corrected Accuracy % Error calculation for Dispense Module tests.</p> <p><i>Ch 6, Preventive Maintenance:</i> Added instructions for inspecting/cleaning mirrors.</p> <p><i>Appendix A, Specifications:</i> Added support for the Take3 plate.</p> <p><i>Appendix B, Error Codes:</i> Updated error code descriptions.</p>
D	3/2010	<p><i>Preface:</i> Updated Directive 98/79/EC: In Vitro Diagnostics.</p> <p><i>Ch 2, Installation:</i> Corrected typo in the step heading numbers.</p> <p><i>Ch 5, Instrument Qualification:</i> For the luminescence test using the Harta Luminometer Reference Microplate, moved the background (buffer) wells from rows C and D to rows F and G. For the background read step, changed the Top Probe Vertical Offset to 4.00 mm.</p> <p><i>Ch 6, Preventive Maintenance:</i> Under “Run a Dispense Protocol (Optional),” added instruction to set the Plate Type in the Gen5 protocol to match the plate being used for the test.</p>
E	4/2010	<p><i>Ch 5, Instrument Qualification:</i> For the luminescence test using the Harta Luminometer Reference Microplate, corrected errors in the Gen5 protocol reading parameter table on page 123 (read step 3).</p>

Document Conventions

This manual uses the following typographic conventions:

Example	Description
	This icon calls attention to important safety notes.
Warning!	A Warning indicates the potential for bodily harm and tells you how to avoid the problem.
Caution	A Caution indicates potential damage to the instrument and tells you how to avoid the problem.
Note	Bold text is primarily used for emphasis.
	This icon calls attention to important information.

Intended Use Statement

The Synergy 2 is a single-channel multi-mode microplate reader. The performance characteristics of the data reduction software have not been established with any laboratory diagnostic assay. The user must evaluate this instrument and PC-based software in conjunction with the specific assay(s). This evaluation must include the confirmation that performance characteristics for the specific assay(s) are met.

BioTek Gen5 software package provides the user with instrument control and data reduction capabilities.

The Synergy 2 can operate with standard robotic systems, such the BioStack Microplate Stacker.

This product may be used for In Vitro Diagnostic, research and development, or other non-clinical purposes.

Quality Control

It is considered good laboratory practice to run laboratory samples according to instructions and specific recommendations included in the assay package insert for the test to be conducted. Failure to conduct Quality Control checks could result in erroneous test data.

Warranty and Product Registration

Please review the Warranty information that shipped with your product. Register your product with BioTek to ensure that you receive important information and updates. Register online through the Customer Resource Center (CRC) at www.biotek.com or by calling (888) 451-5171 or (802) 655-4740.

Warnings



Operate the instrument on a level surface away from excessive humidity.

Strong light can reduce the linear performance range of the instrument.

Measurement values may be affected by extraneous particles (such as dust) in the microplate wells. A clean work area is necessary to ensure accurate readings.

When operated in a safe environment according to the instructions in this document, there are no known hazards associated with the instrument. However, the operator should be aware of certain situations that could result in serious injury; these may vary depending on the instrument model. See **Hazards** and **Precautions**.

Hazards

The following hazard warnings are provided to help avoid injury:



Warning! Power Rating. The instrument's power supply cord must be connected to a power receptacle that provides voltage and current within the specified rating for the system. Use of an incompatible power receptacle may produce electrical shock and fire hazards.

Warning! Electrical Grounding. Never use a two-prong plug adapter to connect primary power to the external power supply. Use of an adapter disconnects the utility ground, creating a severe shock hazard. Always connect the power supply directly to an appropriate receptacle with a functional ground.



Warning! Internal Voltage. Always turn off the power switch and unplug the power supply before cleaning the outer surface of the instrument.

Warning! Liquids. Avoid spilling liquids on the reader; fluid seepage into internal components creates a potential for shock hazard or instrument damage. If a spill occurs while a program is running, abort the program and turn off the instrument. Wipe up all spills immediately. Do not operate the instrument if internal components have been exposed to fluid.

Warning! Unspecified Use. Failure to operate this equipment according to the guidelines and safeguards specified in this manual could result in a hazardous condition.

Warning! Software Quality Control. The operator must follow the manufacturer's assay package insert when modifying software parameters and establishing reading methods. Failure to conduct quality control checks could result in erroneous test data.

Warning! Reader Data Reduction Protocol. No limits are applied to the raw absorbance data. All information exported via computer control must be thoroughly analyzed by the operator.



Warning! Hot Surface. The tungsten lamp assembly is hot when the instrument is turned on. Turn off the reader and allow the lamp to cool down before attempting to replace it.



Warning! Pinch Hazard. Some areas of the Dispense Module can present pinch hazards when the instrument is operating. These areas are marked with the symbol shown in the Safety Symbols section of this Preface. Keep hands/fingers clear of these areas when the instrument is operating.



Warning! Potential Biohazards. Some assays or specimens may pose a biohazard. Adequate safety precautions should be taken as outlined in the assay's package insert. Always wear safety glasses and appropriate protective equipment, such as chemically resistant rubber gloves and an apron.

Precautions

The following precautions are provided to help avoid damage to the instrument:



Caution: Service. The instrument should be serviced by BioTek authorized service personnel. Only qualified technical personnel should perform troubleshooting and service procedures on internal components.

Caution: Environmental Conditions. Do not expose the system to temperature extremes. For proper operation, ambient temperatures should remain within the range listed in the **Specifications** section of Chapter 1. Performance may be adversely affected if temperatures fluctuate above or below this range. Storage temperature limits are broader.

Caution: Sodium Hypochlorite. Do not expose any part of the instrument to the recommended diluted sodium hypochlorite solution (bleach) for more than 20 minutes. Prolonged contact may damage the instrument surfaces. Be certain to rinse and thoroughly wipe all surfaces.

Caution: External Power Supply. Only use the power supply shipped with the instrument. Operate this power supply within the range of line voltages listed on it.



Caution: Shipping Panel/ Hardware. The shipping panel, carrier shipping screw, optic arm shipping block, and mirror holder shipping bracket must be removed before operating the instrument. They must be reinstalled before repackaging the reader for shipment. See **Chapter 2, Installation**.

Caution: Disposal. This instrument contains printed circuit boards and wiring with lead solder. Dispose of the instrument according to Directive 2002/96/EC, “on waste electrical and electronic equipment (WEEE)” or local ordinances.

Caution: Warranty. Failure to follow preventive maintenance protocols may void the warranty. See **Chapter 6** for preventive maintenance procedures.

Caution: Electromagnetic Environment. Per IEC 61326-2-6 it is the user’s responsibility to ensure that a compatible electromagnetic environment for this instrument is provided and maintained in order that the device will perform as intended.

Caution: Electromagnetic Compatibility. Do not use this device in close proximity to sources of strong electromagnetic radiation (e.g., unshielded intentional RF sources), because these may interfere with the proper operation.

CE Mark



Based on the programs described below and information contained herein, this product bears the CE mark.

❖ See the Declaration of Conformity for more information.

Directive 89/ 336/ EC: Electromagnetic Compatibility

Emissions - Class A

The system has been type tested by an independent, accredited testing laboratory and found to meet the requirements of EN 61326-1 and EN61326-2-6: Class A for Radiated Emissions and Line Conducted Emissions.

Verification of compliance was conducted to the limits and methods of EN 55011 – (CISPR 11) Class A. In a domestic environment it may cause radio interference, in which case you may need to mitigate the interference.

Immunity

The system has been type tested by an independent, accredited testing laboratory and found to meet the requirements of EN 61326-1 and EN 61326-2-6 for Immunity.

Verification of compliance was conducted to the limits and methods of the following:

EN 61000-4-2 Electrostatic Discharge

EN 61000-4-3 Radiated EM Fields

EN 61000-4-4 Electrical Fast Transient/Burst

EN 61000-4-5 Surge Immunity
EN 61000-4-6 Conducted Disturbances from RFI
EN 61000-4-11 Voltage Dips, Short Interruptions and Variations

Directive 73/ 23/ EEC Low Voltage (Safety)

The system has been type tested by an independent testing laboratory and was found to meet the requirements of EC Directive 73/23/EEC for Low Voltage. Verification of compliance was conducted to the limits and methods of the following:

EN 61010-1:2001, "Safety requirement for electrical equipment for measurement, control and laboratory use. Part 1, General requirements."

EN 61010-2-81:2003, "Requirements for automatic and semi-automatic laboratory equipment for analysis and other purposes."

EN 61010-101:2002, "Particular requirements for in vitro diagnostic (IVD) medical equipment."

Directive 2002/ 96/ EC: Waste Electrical and Electronic Equipment

Disposal Notice: This instrument contains printed circuit boards and wiring with lead solder. Dispose of the instrument according to Directive 2002/96/EC, "on waste electrical and electronic equipment (WEEE)" or local ordinances.

Directive 98/ 79/ EC: In Vitro Diagnostics

- Product registration with competent authorities
- Traceability to the U.S. National Institute of Standards and Technology (NIST)

Electromagnetic Interference and Susceptibility

USA FCC CLASS A

Warning: Changes or modifications to this unit not expressly approved by the manufacturer could void the user's authority to operate the equipment.

This equipment has been tested and found to comply with the limits for a Class A digital device, pursuant to Part 15 of the FCC Rules.

These limits are designed to provide reasonable protection against harmful interference when the equipment is operated in a commercial environment. Like all similar equipment, this equipment generates, uses, and can radiate radio frequency energy and, if not installed and used in accordance with the instruction manual, may cause harmful interference to radio communications. Operation of this equipment in a residential area is likely to cause interference, in which case the user will be required to correct the interference at his own expense.

Canadian Department of Communications Class A

This digital apparatus does not exceed Class A limits for radio emissions from digital apparatus set out in the Radio Interference Regulations of the Canadian Department of Communications.

Le present appareil numerique n'emet pas du bruits radioelectriques depassant les limites applicables aux appareils numerique de la Class A prescrites dans le Reglement sur le brouillage radioelectrique edicte par le ministere des Communications du Canada.

User Safety

This device has been type tested by an independent laboratory and found to meet the requirements of the following:

- Underwriters Laboratories UL 61010-1: 2004, "Safety requirements for electrical equipment for measurement, control and laboratory use; Part 1: general requirements"
- Canadian Standards Association CAN/CSA C22.2 No. 61010-1-04 , "Safety requirements for electrical equipment for measurement, control and laboratory use; Part 1: general requirements"
- EN 61010 Standards - See CE Mark list

Safety Symbols

Some of these symbols appear on the instrument or accessories:

 <p>Alternating current Courant alternatif Wechselstrom Corriente alterna Corrente alternata</p>	 <p>Both direct and alternating current Courant continu et courant alternatif Gleich - und Wechselstrom Corriente continua y corriente alterna Corrente continua e corrente alternata</p>
 <p>Direct current Courant continu Gleichstrom Corriente continua Corrente continua</p>	 <p>Earth ground terminal Borne de terre Erde (Betriebserde) Borne de tierra Terra (di funzionamento)</p>
 <p>On (Supply) Marche (alimentation) Ein (Verbindung mit dem Netz) Conectado Chiuso</p>	 <p>Protective conductor terminal Borne de terre de protection Schutzleiteranschluss Borne de tierra de protección Terra di protezione</p>
 <p>Off (Supply) Arrêt (alimentation) Aus (Trennung vom Netz) Desconectado Aperto (sconnessione dalla rete di alimentazione)</p>	 <p>Caution (refer to accompanying documents) Attention (voir documents d'accompagnement) Achtung siehe Begleitpapiere Atención (vease los documentos incluidos) Attenzione, consultare la doc annessa</p>
 <p>Warning, risk of electric shock Attention, risque de choc électrique Gefährliche elektrische schlag Precaución, riesgo de sacudida eléctrica Attenzione, rischio di scossa elettrica</p>	 <p>Warning, risk of crushing or pinching Attention, risque d'écrasement et pincement Warnen, Gefahr des Zerquetschens und Klemmen Precaución, riesgo del machacamiento y sejeción Attenzione, rischio di schiacciare ed intrappolarsi</p>
 <p>Warning, hot surface Attention, surface chaude Warnen, heiße Oberfläche Precaución, superficie caliente Attenzione, superficie calda</p>	 <p>Warning, potential biohazards Attention, risques biologiques potentiels Warnung! Moegliche biologische Giftstoffe Atención, riesgos biológicos Attenzione, rischio biologico</p>



In vitro diagnostic medical device

Dispositif médical de diagnostic in vitro

Medizinisches In-Vitro-Diagnostikum

Dispositivo médico de diagnóstico in vitro

Dispositivo medico diagnostico in vitro



Separate collection for electrical and electronic equipment

Les équipements électriques et électroniques font l'objet d'une collecte sélective

Getrennte Sammlung von Elektro- und Elektronikgeräten

Recogida selectiva de aparatos eléctricos y electrónicos

Raccolta separata delle apparecchiature elettriche ed elettroniche



Consult instructions for use

Consulter la notice d'emploi

Gebrauchsanweisung beachten

Consultar las instrucciones de uso

Consultare le istruzioni per uso

Chapter 1

Introduction

This chapter introduces the Synergy 2, describes its key features, and lists its package contents. Page 24 contains information on contacting BioTek for product support and service.

Product Description	20
Package Contents	21
Optional Accessories	22
Product Support and Service	24

Product Description

Depending on the model, Synergy 2 detection modes include Fluorescence Intensity (FI), Fluorescence Polarization (FP), Time-Resolved Fluorescence (TRF), Luminescence and UV-visible Absorbance. The Synergy 2 is a single-channel microplate reader for research and development and in vitro diagnostic use.

Synergy 2 uses a unique combination of monochromator, filters and dichroic mirrors. Its three broad-spectrum light sources have been chosen for optimal illumination and excitation in all applications. The reader is computer-controlled using BioTek's Gen5 PC software for all operations including data reduction and analysis. The Synergy 2 is robot accessible and compatible with BioTek's BioStack Microplate Stacker. Gen5 supports OLE automation to facilitate the Synergy 2's integration into an automated system.

Two light sources are available for Fluorescence determinations, a tungsten halogen lamp (part of the FI and FP modules) or a xenon flash (part of the TRF module) along with interference filters and dichroic mirrors for wavelength specificity, and a photomultiplier tube (PMT) detector. The Synergy 2 has both top and bottom probes for fluorescence measurements. Bottom probe readings do not use the mirrors. The Synergy 2 models with Fluorescence Polarization (FP) capability are equipped with polarizing filters.

Luminescence is measured by the low-noise PMT detector through an empty filter position in the Emission filter wheel. Filters can also be used if light filtering is necessary.

Absorbance measurements are made by switching to a super-quiet xenon flash lamp and a monochromator for wavelength selection. The xenon lamp allows for both UV and visible light absorbance measurements. The monochromator provides wavelength selection from 200 to 999 nm in 1-nm increments. Area and spectral scanning, and Pathlength Correction are available read methods.

The Synergy 2 has a 4-Zone™ temperature control from 4°C over ambient to 50°C. Internal plate shaking is supported to ensure that reagents are properly mixed prior to reading.

The Synergy 2 supports the reading of 6-, 12-, 24-, 48-, 96-, 384-, and 1536-well microplates with standard 128 x 86 mm geometry, as well as the BioTek Take3 Multi-Volume Plate.

Note: The Luminescence system does not support the reading of 1536-well plates.

Models with injectors support dual-reagent dispensing to 6-, 12-, 24-, 48-, and 96-well microplates. An external dispense module pumps fluid from the supply bottles to the two injectors located inside the instrument. Both injectors are positioned directly above the bottom probe, and fluid is injected into one well at a time.

Package Contents

❖ Part numbers and package contents are subject to change. Contact BioTek Customer Care with any questions.

Item	Part #
Synergy 2 Operator's Manual	7131000
Power supply	7130560
Power cord set (specific to installation environment):	
Europe (Schuko)	75010
USA/International	75011
United Kingdom	75012
Australia/New Zealand	75013
RS-232 serial cable	75034
USB cable with Virtual COM Driver Software	75108 7090204
Wrench	48576
Filter "plugs" (2) (also referred to as "dummy filters" or "blanks")	7082073
Spare filter retaining clips (2)	7082075
Plastic storage bag and Velcro strips	—
Models with injectors ("D" dispenser models), an external dispense module (packed separately), with the following accessories:	
Outlet tubes (2, plus 2 spare) from dispense module to instrument	7082120
Inlet tubes (2) from supply bottles to syringe drives	7082121
250 µl syringes (2)	7083000
Syringe thumbscrews (2)	19511
Priming plate	7132158
Injector tip priming trough	7092133
Dispense module communication cable	75107
Dispense module front cover	7082137
Dispense module box	7090568
Supply bottles (2, 30 ml)	7122609
Supply bottle holder assemblies (2)	7090564
Injector tip cleaning stylus and plastic storage bag	2872304

Optional Accessories

❖ Part numbers and accessories are subject to change. Contact BioTek Customer Care with any questions or visit www.biotek.com and use the Accessories search tool.

Item	Part #
Synergy 2 Product Qualification (IQ-OQ-PQ) package	7130012
Test Plate for absorbance measurement testing	7260522
Harta Luminometer Reference Microplate and Adapter	8030015
Glowell Adapter Plate	7160006
Take3 Multi-Volume Plate	TAKE3
BioCell Quartz Vessel	7272051
BioCell Adapter Plate	7270512
PCR Tube Adapter Plates	6002072 6002076
Terasaki Adapter Plate	7330531
UV-Range (300 nm and above) Excitation Polarizer	7132041
3-foot (1 meter) external Dispense Module tubing	7112186
Empty filter wheel	7080541
Filter retainer clip	7082075
Filter wheel plug (dummy filter)	7082073
Empty mirror holder	7130564
Empty mirror holder, FP-compatible	7130563
Replacement Tungsten Lamp	7080500
Replacement Shipping Materials	7130016
Additional Filters, Filter Wheels, Mirrors, and Mirror Holders; contact BioTek for part numbers and availability.	
The Synergy 2 is compatible with the BioStack Microplate Stacker. Contact BioTek or visit our website to learn more.	

For Use with Liquid Tests (see Chapter 5)	Part #
Absorbance Liquid Test Solutions:	
BioTek Wetting Agent Solution	7773002
BioTek QC Check Solution #1	
25 mL	7120779
125 mL	7120782
Dispense Module Liquid Test Solution:	
BioTek Green Test Dye	7773003

For Use with Liquid Tests (see Chapter 5)	Part #
Fluorescence Test Kits (includes microplates and solutions): Complete Kit (Sodium Fluorescein, Europium, Methylumbelliferone) Sodium Fluorescein Kit Fluorescence Polarization Kit TRF Europium Kit Methylumbelliferone "MUB" Kit	7160010 7160013 7160014 7160011 7160012
Individual Fluorescence Liquid Test Solutions: Sodium Fluorescein Powder 10 mg vial of Methylumbelliferone ("MUB") Carbonate-Bicarbonate Buffer ("CBB") capsules	98155 98156 98158
Fluorescence Polarization Liquid Test Solutions are also available from Invitrogen Corporation, in their "FP One-Step Reference Kit," part number P3088.	
The Time-Resolved Fluorescence Liquid Test Solution is also available from Invitrogen Corporation: FluoSpheres carboxylate-modified microspheres, 0.2 µm europium luminescent, 2 mL, PN F20881.	

Product Support and Service

Technical Assistance Center (TAC)

If your instrument or software fails to function properly, if you have questions about how to use or maintain our products, or if you need to send an instrument to BioTek for service or repair, please contact our Technical Assistance Center (“TAC”).

The TAC is open from 8:30 AM to 5:30 PM (EST), Monday through Friday, excluding standard U.S. holidays.

Phone: (800) 242-4685 or (802) 655-4740 Fax: (802) 654-0638 E-Mail: tac@biotek.com
Web: www.biotek.com

Please be prepared to provide the following information:

- Your name and company information, along with a daytime phone or fax number, and/or an e-mail address
- The product name, model, and serial number
- The onboard software part number and basecode version (in Gen5, select System > Reader Control > Information)
- For troubleshooting assistance or instruments needing repair, the specific steps that produce your problem and any error codes displayed in Gen5 (see also **Appendix B, Error Codes**)

If you need to return an instrument to BioTek for service or repair, please contact the TAC for a Return Materials Authorization (RMA) number and the shipping address. See page 43 for repackaging instructions.

Applications Support

BioTek’s fully equipped Application Laboratory provides our on-staff scientists with the means to assist you with the integration of our instrumentation and software with your unique scientific applications. If you are having difficulty with optimizing fluorescence sensitivity or integrating a unique data reduction transformation, or you are just looking for a recommendation on an appropriate fluorophore, contact us.

Phone: (888) 451-5171 E-Mail: applications@biotek.com

Chapter 2

Installation



This chapter includes instructions for unpacking and setting up the reader and its components.

Product Registration	26
Important Information	26
1: Unpack and Inspect the Reader	27
2: Unpack and Inspect the Dispense Module	28
3: Select an Appropriate Location	29
4: Remove the Shipping Hardware	29
5: Install the Power Supply	34
6: Install the Dispense Module	35
7: Connect the Host Computer	37
8: Install Gen5 on the Host Computer	38
9: Turn on the Power Supply and Reader	38
10: Establish Communication	39
11: Run a System Test	39
12: Test the Injector System	41
Operational/Performance Qualification	42
Repackaging and Shipping Instructions	43

Product Registration

If you have not already done so, please register your product(s) with BioTek to ensure that you receive important information and updates about the products you have purchased. Register online through the BioTek Customer Resource Center at www.biotek.com or by contacting BioTek Customer Care (see page 8).

Important Information

	<p>This chapter contains installation and setups tasks for a Synergy 2 reader configured with all of the available modules (the “SLFPTAD” model). Your Synergy 2 model may be different. For example, it may not have injection capability, or it may not have an Excitation filter wheel (“SL” and “SLD” models). Perform the installation and setup tasks in the order presented, skipping those that do not apply to your reader’s configuration.</p> <p>Materials: You will need a slotted screwdriver and a Phillips-head screwdriver to perform some of the steps in this section. You will also need a small wrench; this item is supplied with the instrument.</p>
	<p>Remove the shipping hardware before turning on the instrument.</p> <p>Re-install the shipping hardware and attach the shipping panel before repackaging the instrument for shipment.</p>

1: Unpack and Inspect the Reader



The reader should be removed from the box by two people. It weighs up to **57 pounds (25.8 kg)**, depending on the model.

Save all packaging materials. If you need to ship the reader to BioTek for repair or replacement, you must use the original materials. Using other forms of commercially available packaging, or failing to follow the repackaging instructions, may **void your warranty**.

During the unpacking process, inspect the packaging, reader, and accessories for shipping damage. If the reader is damaged, notify the carrier and your BioTek representative. Keep the shipping boxes and the packaging materials for the carrier's inspection. BioTek will arrange for repair or replacement of your reader immediately.

1. Set the outer shipping box close to the intended work surface. Open the outer shipping box and remove the foam blocks to access the inner shipping box.
2. Open the inner shipping box. Remove the accessories that are stored inside the cardboard shipping insert and then remove the insert.
3. The reader is attached to a shipping panel, which has two handles for lifting (see **Figure 1** on page 28). With one person on each side, locate and grasp the handles. Carefully lift the reader out of the box. Place the reader on its back on the work surface, so the reader lies flat and the panel hangs over the edge of the surface.
4. Using a slotted screwdriver, remove the screws and washers that attach the panel to the reader. Carefully set the reader upright.
5. Place the panel with the screws and washers into the shipping box for storage. Place the packaging materials in the shipping boxes for reuse if the reader needs to be shipped again.



Figure 1: The reader on its back with the shipping panel attached to the bottom (left), and removing the screws (right).

2: Unpack and Inspect the Dispense Module



Save all packaging materials. If you need to ship the dispense module to BioTek for repair or replacement, you must use the original materials. Using other forms of commercially available packaging, or failing to follow the repackaging instructions, may void your warranty.

During the unpacking process, inspect the packaging, module, and accessories for shipping damage. If the module is damaged, notify the carrier and your BioTek representative. Keep the shipping boxes and the packing materials for the carrier's inspection. BioTek will arrange for repair or replacement of your dispense module immediately.

1. Open the outer shipping box. Remove the foam cap, inner shipping box, and accessories box.
2. Open the inner shipping box. Remove the two reagent bottle holders and the cardboard shipping insert. Lift out the module and place it on a level surface.
3. Open the accessories box and remove its contents. The accessories should include the dispense module-related items on page 21.
4. Place all packaging materials into the shipping box for reuse if the dispense module needs to be shipped again.

3: Select an Appropriate Location

Install the reader on a level surface in an area where ambient temperatures between 18°C (64°F) and 40°C (104°F) can be maintained. The reader is sensitive to extreme environmental conditions. Avoid the following:

- **Excessive humidity.** Condensation directly on the sensitive electronic circuits can cause the instrument to fail internal self-checks. The humidity must be in the range of 10-85%, non-condensing.
- **Excessive ambient light.** Bright light may affect the reader's optics and readings, reducing its linear range.
- **Dust.** Readings may be affected by extraneous particles (such as dust) in the microplate wells. A clean work area is necessary to ensure accurate readings.

4: Remove the Shipping Hardware



Caution: Remove all shipping hardware before you turn the reader on.

1. Locate the **two** screws that secure the shroud; one on each side of the reader, in the lower rear corners. Remove the screws (**Figure 2**) and slide off the shroud (**Figure 3**).



Figure 2: Removing the two side screws.



Figure 3: Sliding off the shroud.

2. Identify the areas inside the instrument where the shipping hardware is currently installed, and where some items will be stored:

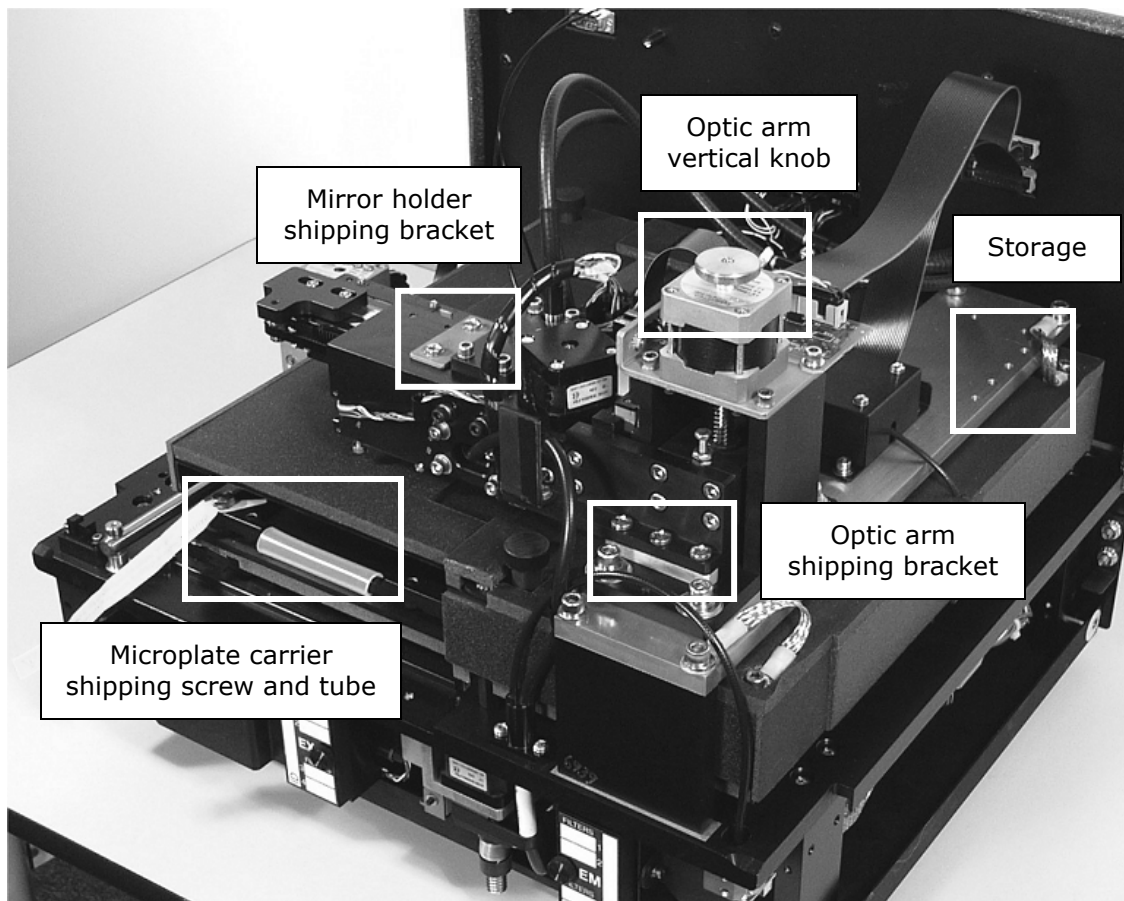

Figure 4: Internal compartment, with shipping hardware.

- Use the supplied wrench to remove the microplate carrier shipping screw. You will store the screw on the base plate as shown in **Figure 7**. Pull the flexible carrier shipping tube off of the carrier. Store the tube in the plastic storage pocket. Use the supplied Velcro strips to attach the pocket to the back of the reader for storage.

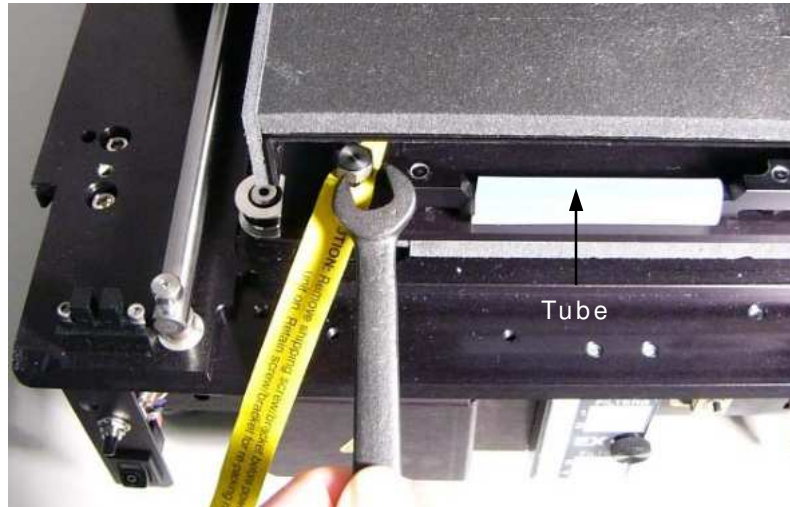

Figure 5: Remove microplate carrier shipping screw and tube.

- Remove three screws (with washers) that hold the optic arm shipping block in place. Turn the knob at the top of the motor clockwise to raise the optic arm. Slide the block out from under the arm.

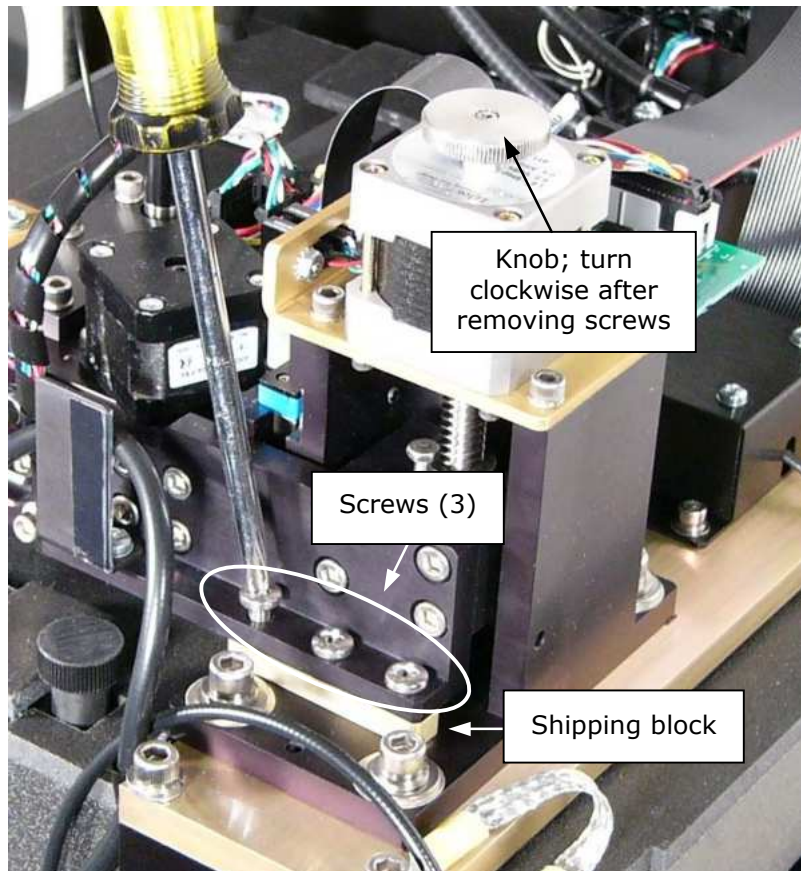

Figure 6: Removing the optic arm shipping block

5. Store the optic arm shipping block and three screws/washers on the base plate.

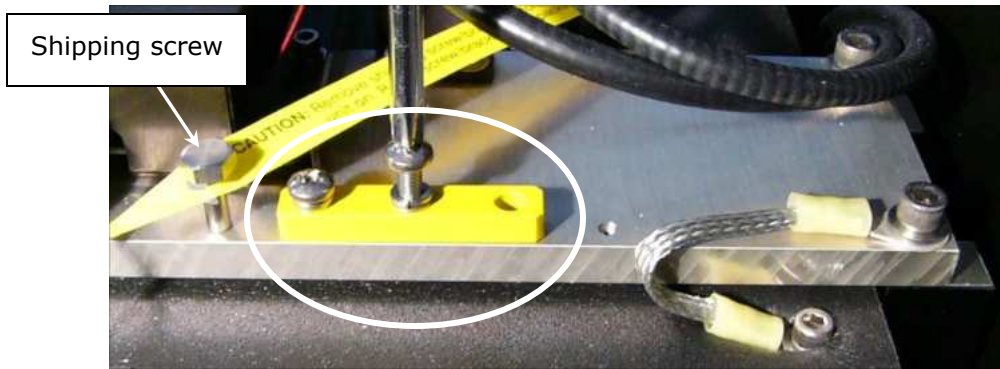

Figure 7: Carrier shipping screw and optic arm shipping block stored on the base plate.

6. Remove the two screws that secure the mirror holder shipping bracket.

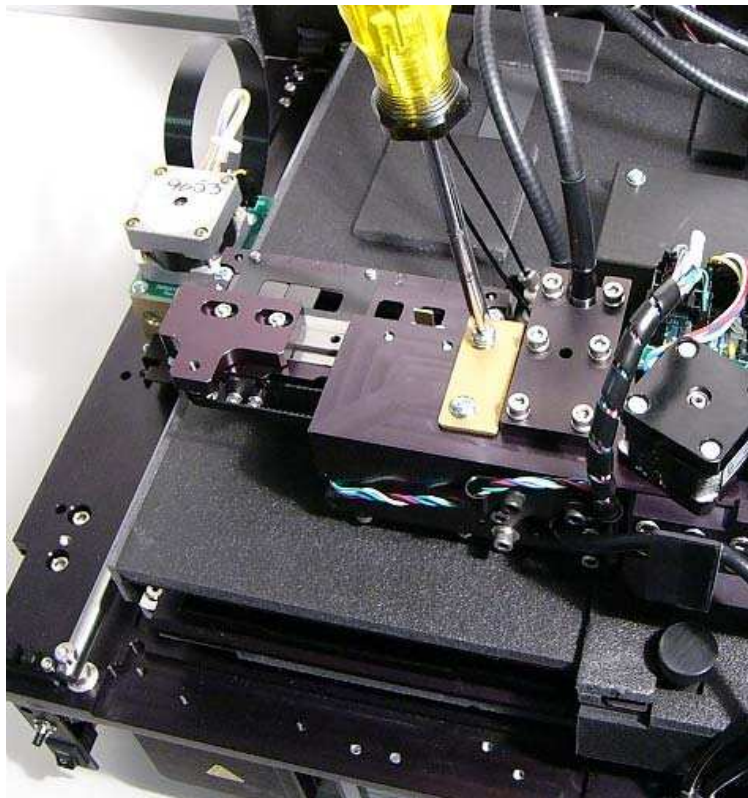

Figure 8: Removing the mirror holder shipping bracket.

7. Turn the bracket over and replace the screws.

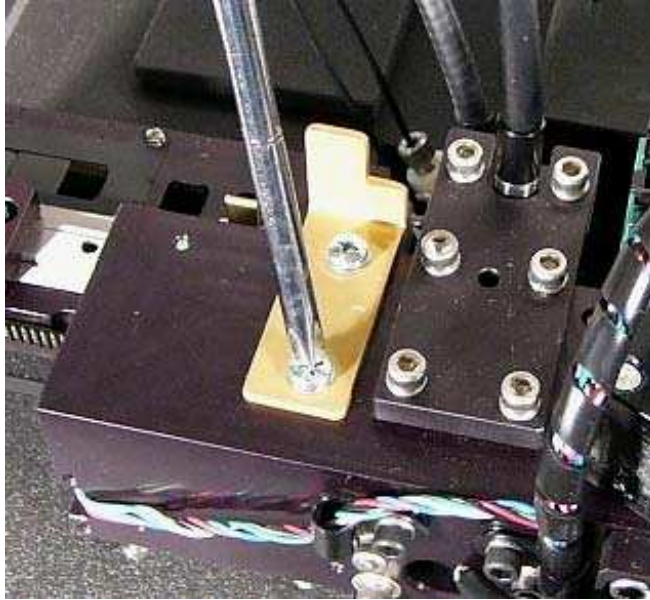

Figure 9: The mirror holder shipping bracket in its storage position.

8. Slide the shroud onto the reader and replace the two side screws (**Figure 3** on page 30).

5: Install the Power Supply



Warning! Power Rating. The instrument must be connected to a power receptacle that provides voltage and current within the specified rating for the system. Use of an incompatible power receptacle may produce electrical shock and fire hazards.

Warning! Electrical Grounding. Never use a plug adapter to connect primary power to the instrument. Use of an adapter disconnects the utility ground, creating a severe shock hazard. Always connect the system power cord directly to an appropriate receptacle with a functional ground.

Perform these steps to install the power supply:

1. Locate the power inlet on the right side of the reader, it is labeled "POWER IN."
2. Examine the power supply's plug. It has a small groove that will line up with a tab inside the power inlet. The plug is encircled by a securing ring.
3. Insert the plug into the power inlet. Align the groove with the tab and twist the ring clockwise until the plug is firmly seated.
4. Plug the power supply's cord into an appropriate power receptacle.



Figure 10: The external power supply (left) and the reader's power inlet (right).

6: Install the Dispense Module

1. Place the dispense module on top of the reader.



Figure 11: The dispense module on top of the reader.

2. On the rear panel of the reader, identify the SYRINGE 1 and SYRINGE 2 tubing ports. Remove the nylon screws from both ports.
3. Open two of the plastic bags containing the outlet tubes. Remove the clear plastic fitting shrouds from the tubes. Put the other two bags in a safe place; they are spares.
4. Place the nylon screws and the plastic fitting shrouds in the plastic tool storage bag. Use the supplied Velcro strips to attach the bag to the rear panel of the dispense module.
5. Remove the two inlet tubes from their protective plastic canisters.
6. Identify the two circular syringe valves on the dispense module. Each is labeled with a left-pointing arrow.

❖ When installing the inlet and outlet tubes, do not use any tools. Finger-tighten only!

7. Screw the fitting of one inlet tube into the right side of the Syringe 1 valve.
8. Screw one end of one outlet tube into the left side of the Syringe 1 valve.
9. Screw the other end of the outlet tube into the SYRINGE 1 port on the rear of the reader.
10. Repeat these steps to attach the inlet and outlet tubing for Syringe 2.
11. Seat the outlet tubes in the clip to the left of the Syringe 2 valve.

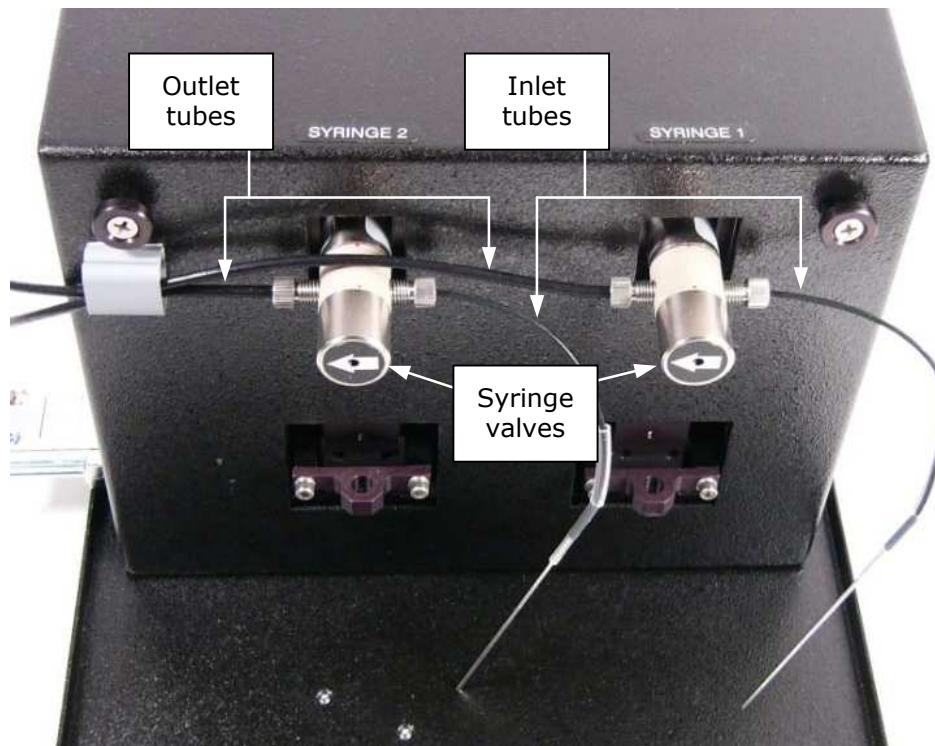

Figure 12: The dispense module's outlet and inlet tubes, and syringe valves.

12. Remove the two syringes from their protective boxes. They are identical and interchangeable. Each syringe should already be assembled, but if there are two separate pieces, assemble them now: insert the white tip of the syringe plunger into the barrel of the syringe and gently push it all the way into the barrel.
13. Install both syringes, referring to **Figure 13**.
 - Hold the syringe vertically with the threaded end at the top and the knurled steel end at the bottom.
 - Screw the threaded end of the syringe into the bottom of the syringe valve. Finger-tighten only.

- Carefully pull down the knurled steel end of the syringe until it is resting inside the hole in the bracket.
- Pass a metal thumbscrew up through this hole and thread it into the bottom of the syringe. Hold the syringe from rotating while tightening the thumbscrew. Finger-tighten only.

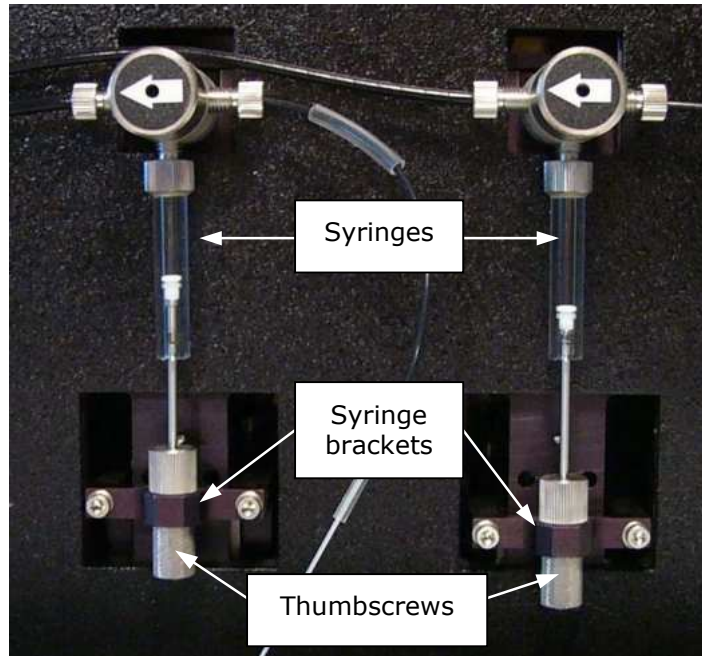

Figure 13: The dispense module; close-up view of the syringes.

14. Locate the dispense module cable. Plug one end into the port on the left side of the dispense module. Plug the other end into the “Dispenser Port” on the right side of the reader.
15. Locate the injector tip-cleaning stylus, packaged in a small plastic cylinder. Attach the cylinder to the back of the dispense module for storage.

7: Connect the Host Computer

The Synergy 2 is equipped with two types of communication ports: Serial (RS-232) and USB.

- Both types of cables are included in the accessories box. Determine which cable is supported by the host computer.
- Connect one end to the appropriate port on the reader and the other end to the appropriate port on the host computer.

8: Install Gen5 on the Host Computer



The Synergy 2 is controlled by Gen5 software running on a host computer. There is a certain sequence of events that must be followed to ensure that the software is properly installed and configured. Please follow the instructions provided in the Gen5 Getting Started Guide to install the software.

9: Turn on the Power Supply and Reader

1. If Gen5 is open, close it now.
2. The power supply has its own switch. Locate the switch and turn the power supply on.
3. The reader's power switch is located on the lower left corner of the front panel. Locate the switch and turn the reader on. The reader will perform a System Test. When the test is complete, the microplate carrier will eject.

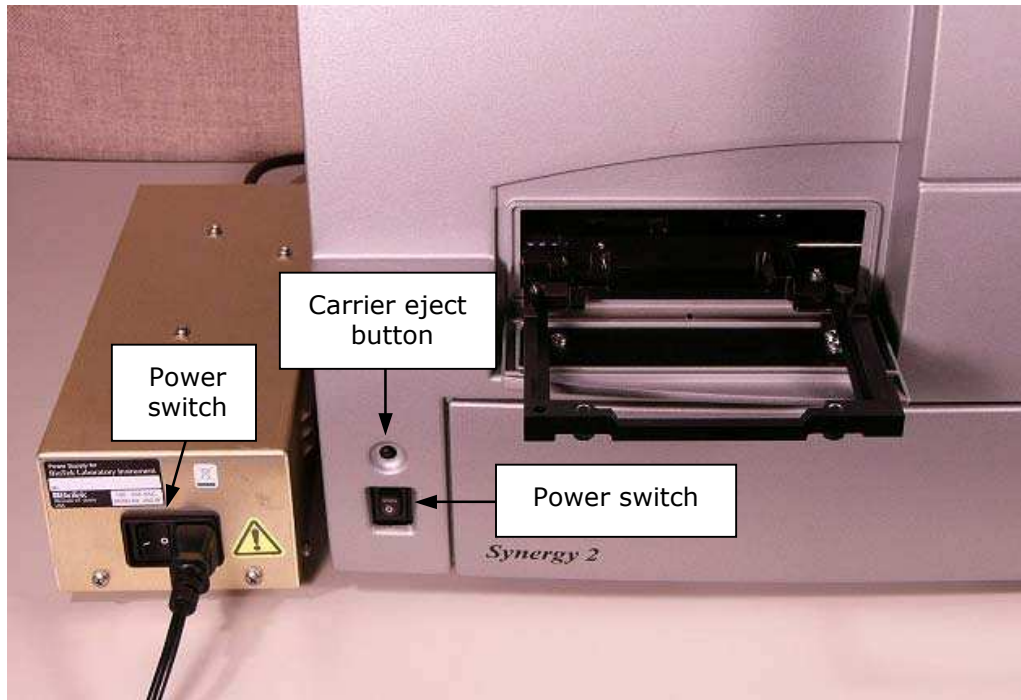

Figure 14: The reader with its microplate carrier extended.

- ❖ The carrier eject button, located above the reader's power switch, is used to extend/retract the microplate carrier.

10: Establish Communication

1. If you are using the USB cable, refer to the instructions that shipped with the USB Driver Software CD to install the necessary drivers.
2. Start Gen5 and log in if prompted.

❖ The default System Administrator password is admin.

3. Open the System Menu and select Reader Configuration.
4. Click Add and set the Reader Type to Synergy 2.
5. Set the Com Port to the computer's COM port to which the reader is attached.
6. Click Test Comm. Gen5 attempts to communicate with the reader. If the attempt is successful, return to the Gen5 main screen.

Communication Errors

- Is the reader connected to the power supply and turned on?
- Is the communication cable firmly attached at both ends?
- Did you select the correct Reader Type in Gen5?
- Try a different Com Port.
- If using the USB cable, did you install the driver software?
- If you remain unable to get Gen5 and the reader to communicate with each other, contact BioTek's Technical Assistance Center.

11: Run a System Test

Running a System Test will confirm that the reader is set up and running properly, or will provide an error code if a problem has been detected.

1. Turn on the incubator:
 - In Gen5, select System > Reader Control > Synergy 2.
 - Click the Pre-Heating tab.
 - Enter a Requested temperature of at least 37°C and click On.
 - Return to Gen5's main view.

2. If applicable, adjust Gen5's Absorbance Wavelengths table to values that will confirm operation of the reader at its limits. We recommend 200 and 999 nm (the lower and upper limits of the monochromator), and any four wavelengths in between that best represent your assays and/or the lowest and highest wavelength values typically used in your lab.
 - Select System > Reader Configuration. Highlight the Synergy 2 reader and click View / Modify.
 - Click Setup and then click the Absorbance tab. The six wavelength values currently in use are displayed. (You may wish to make a note of the current values, so you can reset them later.)
 - Enter the six wavelength values you wish to test and then click Send Wavelengths to download them to the reader.

❖ Wait until the incubator temperature reaches the set point before continuing.

3. Select System > Diagnostics > Run System Test. If prompted to select a reader, select the Synergy 2 and click OK.
4. When the test is complete, a dialog will appear to request additional information. Enter the information and click OK.
5. The results report will appear. Scroll down toward the bottom, the text should read "SYSTEM TEST PASS."
 - You may wish to print the report and store it with your Installation records.
 - The software stores system test information in its database; you can retrieve it at any time.

❖ If an error code is returned, refer to Appendix B and look up the code. If the problem is something you can fix, do so now and run another System Test. If the problem is something you cannot fix, or if the test continues to fail, contact BioTek's Technical Assistance Center.

6. Turn off the incubator:
 - Select System > Reader Control > Synergy 2.
 - Click the Pre-Heating tab and click Off.
7. Models with injectors: Keep Gen5 open and proceed to the next section.
All other models: The installation and setup process is complete. Close Gen5 and proceed to **Operational/Performance Qualification** on page 42.

12: Test the Injector System

1. If necessary, press the carrier eject button to eject the microplate carrier.
2. Place the tip priming trough in the left rear pocket of the carrier.
3. Place the priming plate on the carrier.

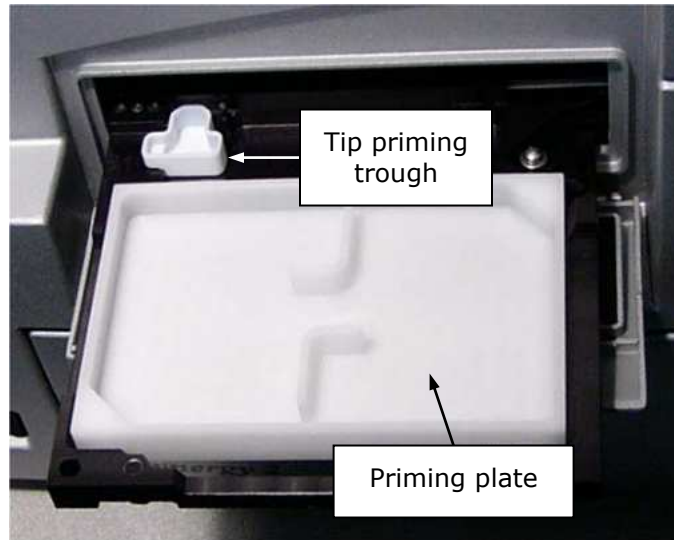

Figure 15: Priming trough and plate installed on the carrier.

4. Fill the two reagent bottles with distilled or deionized water. Place the bottles in their holders, and place the holders directly in front of the syringes. Insert the inlet tubes into the bottles.
5. In Gen5, select System > Reader Control > Synergy 2 (Com < # >)
6. Click the Dispenser tab.
7. With Dispenser set to 1, set the Volume to 5000 μL and click Prime.
The syringe should move down and up repeatedly, drawing fluid from the bottle. The fluid should pump through the tubing and dispense into the priming plate. Examine the fittings; no leaks should be detected. If leaks are detected, tighten all fittings and repeat the prime. If leaks are still detected, contact BioTek TAC.
8. When the prime finishes, set Volume to 2000 μL and click Purge to clear the fluid lines.
9. Set Dispenser to 2 and repeat steps 7 and 8.
10. When finished, remove and empty the priming plate. Close the software.

Operational/ Performance Qualification



Your Synergy 2 reader was fully tested at BioTek prior to shipment and should operate properly following the successful completion of the installation and setup procedures described throughout this chapter.

If you suspect that problems occurred during shipment, if you received the reader back from BioTek following service or repair, and/or if regulatory requirements dictate that Operational/Performance Qualification is necessary, turn to **Chapter 5, Instrument Qualification** now to learn about BioTek's recommended OQ/PQ procedures for the Synergy 2.

- ❖ A Product Qualification & Maintenance (IQ/OQ/PQ) package for the Synergy 2 is available for purchase (PN 7130566). Contact your local BioTek dealer for more information.

Repackaging and Shipping Instructions

Important! Please read the information provided below before preparing the Synergy 2 for shipment.

	<p>If the reader and/or dispense module has been exposed to potentially hazardous material, decontaminate it to minimize the risk to all who come in contact with the reader during shipping, handling and servicing. Decontamination prior to shipping is required by the U.S. Department of Transportation regulations. See Chapter 7, As Needed Maintenance for decontamination instructions.</p> <p>Remove the microplate and tip prime trough (if equipped) from the carrier before shipment. Spilled fluids can contaminate the optics and damage the instrument.</p>
	<p>The instrument's packaging design is subject to change. If the instructions in this section do not apply to the packaging materials you are using, please contact BioTek's Technical Assistance Center for guidance.</p> <p>Replace the shipping hardware before repackaging the reader. Please contact BioTek if you have misplaced any of these items, and order PN 7130016:</p> <ul style="list-style-type: none">• Carrier shipping tube• Carrier shipping screw/o-ring• Optic arm shipping block/screws• Mirror holder shipping bracket/screws <p>If you need to ship the reader and/or the dispense module to BioTek for service or repair, be sure to use the original packaging materials. Other forms of commercially available packaging are not recommended and can void the warranty.</p> <p>The shipping materials are designed to be used no more than five times. If the original materials have been damaged, lost, or used more than five times, contact BioTek to order replacements:</p> <ul style="list-style-type: none">• PN 7133005, shipping container for the Synergy 2 reader• PN 7083001, shipping container for the dispense module

Perform these steps to prepare the **reader** for shipment:

1. Contact BioTek's Technical Assistance Center for an RMA (Return Materials Authorization) number and the shipping address. See page 24 for contact information.
2. Decontaminate the reader and, if attached, the dispense module, according to the instructions provided in **Chapter 7**.
3. If you will also be shipping the dispense module, perform these steps:
 - If you have not already done so as a part of decontamination, purge the dispense module and fluid lines.
 - With the reader on, start Gen5 and select System > Reader Control > Synergy 2 (Com < # >).
 - Perform this step twice, for both dispensers: Click the Dispenser tab and set the dispenser number (1 or 2). Click Maintenance. The syringe bracket will lower. Remove the thumbscrew from underneath the bracket. Carefully unscrew the top of the syringe from the syringe valve. Lift out the syringe and store it in its original box.
 - Fully detach the dispense module from the reader. Replace the two nylon screws into the Syringe 1 and 2 tubing ports on the rear of the reader. (The screws should be stored in the plastic bag attached to the back of the module.) Set the module aside for the moment.
4. If applicable, remove the tip priming trough and store it in the accessories bag.
5. If you have not already done so, retract the microplate carrier and then turn off and unplug the reader.
6. Remove the shroud and replace the shipping hardware (see page 29). Replace the shroud when finished.
7. Carefully tip the reader onto its back. Attach the shipping panel to the bottom of the reader using the four flat-head screws and washers (see page 27).
8. Locate the original outer shipping box. Place four foam blocks in the four bottom corners of the box. Place the inner shipping box inside the outer box.
9. Using two people, grasp the handles on the shipping panel and carefully lower the reader into the inner shipping box.
10. Slide the cardboard insert straight down into place around the reader. Place the accessories inside the pockets in the insert.
11. Close and seal the inner box with tape.
12. Place four foam corner blocks around the inner shipping box. Close and seal the outer box with tape.
13. Write the RMA number in large clear numbers on the outside of the box. Ship the box to BioTek.

Perform these steps to prepare the **dispense module** for shipment:

1. If you have not already done so:
 - Contact BioTek's Technical Assistance Center for an RMA (Return Materials Authorization) number and the shipping address. See page 24 for contact information.
 - Decontaminate the module according to the instructions in **Chapter 7**. Be sure to purge the dispense module of all fluid when finished.
 - Remove the two syringes (see step 3 on the previous page) and store them in their original boxes.
 - Detach the dispense module outlet tubes and communication cable from the reader. Replace the two nylon screws into the Syringe 1 and 2 tubing ports on the rear of the reader.

❖ Refer to the figures on the next pages when performing these steps

2. Remove the two inlet tubes from the syringe valves and store them in their plastic canisters.
3. Remove the two outlet tubes from the syringe valves. Attach the clear plastic fitting shrouds to the fittings of the outlet tubes. Place the tubes in a plastic bag.
4. Place the dispense module inside the inner shipping box. Slide the cardboard shipping insert down around the module. Pack the reagent bottle holders in bubble wrap and place them on top of the module. Seal the box with tape.
5. Locate the original accessories shipping box and foam end caps. Place the bottom foam end cap into the box.
6. Place the syringes, the inlet tubes, and the outlet tubes inside the cutouts of the bottom foam end cap in the accessories box. Place the dispense module shroud on top of the accessories.
7. Shroud the accessories with the top foam end cap, place the dispense module cable inside the top of the end cap, and seal the box with tape.
8. Locate the original outer shipping box and foam end caps. Insert the bottom foam end cap. Lower the dispense module box into the end cap.
9. Insert the accessories box alongside the dispense module box.
10. Insert the top foam end cap. Close and seal the outer box with tape.
11. Write the RMA number in large, clear numbers on the outside of the box. Ship the box to BioTek.

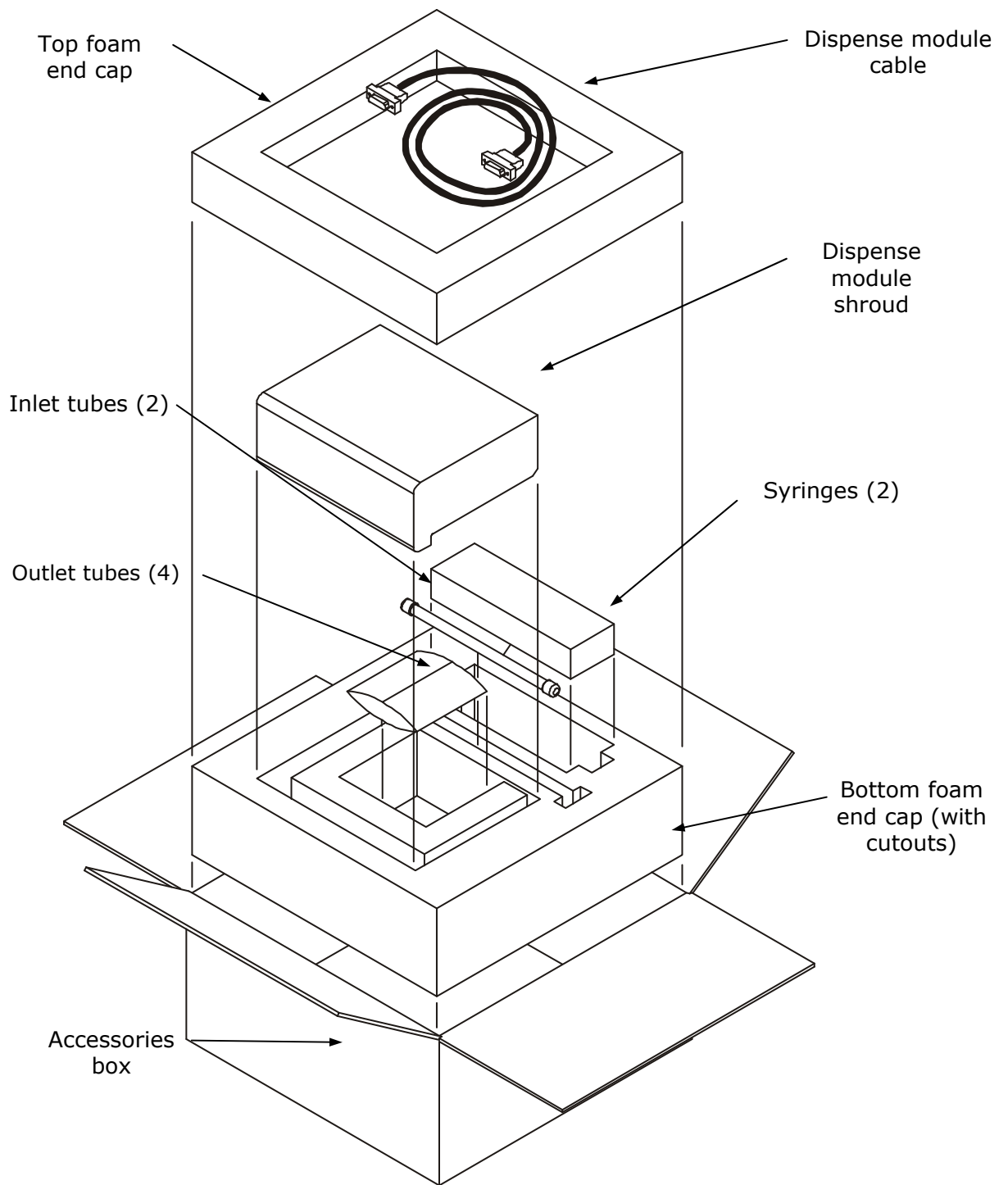

Figure 16: Dispense module accessories.

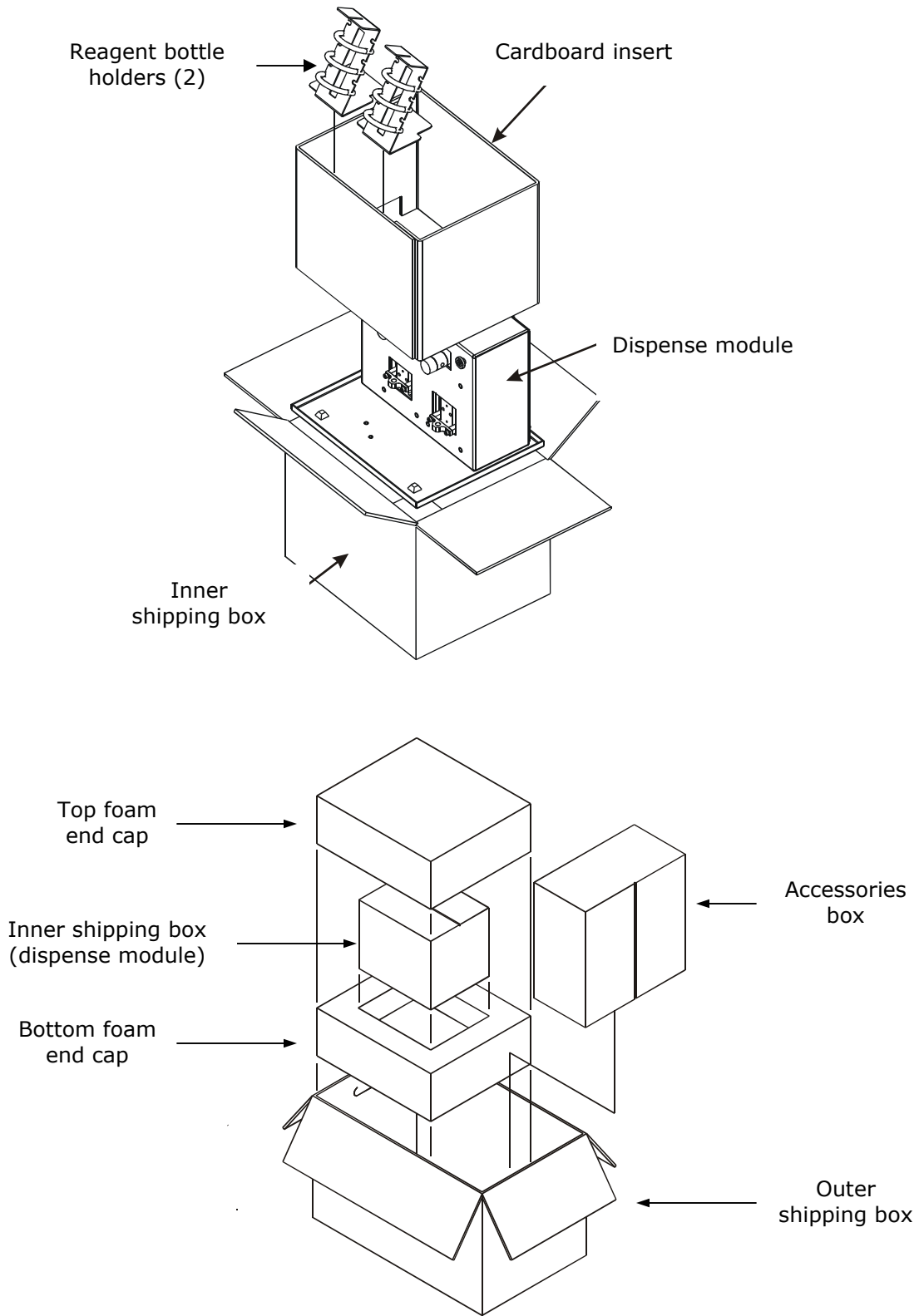

Figure 17: The contents of the inner (top) and outer (bottom) shipping boxes.

Chapter 3

Getting Started

This chapter describes some of the Synergy 2's main external and internal components, and provides an introduction to using Gen5 software to control the instrument.

Modular Design	50
External Components	51
Internal Components.....	52
Tungsten Lamp.....	53
Excitation/Emission Filters.....	54
Mirrors	55
Injector System.....	56
Gen5 Software	59
Define Excitation/Emission Filters.....	59
Define Mirrors	59
Protocols and Experiments	60
Dispense Module Control.....	61
Recommendations for Optimum Performance.....	62

Modular Design

The Synergy 2 is a multi-mode microplate reader, with a design that allows you to initially purchase only the module(s) you need and then upgrade later as your experimental requirements expand. For example, if you initially purchased an “SLFTA” model you can add the Fluorescence Polarization and/or Dispense modules. Please contact BioTek Customer Care to learn more about your upgrade options.

The table below briefly describes the available modules. The module letters form the part number for each Synergy 2 model; for example, a reader with all modules installed is an SLFPTAD. This is indicated on a label on the back of the reader.

Module	Description
S	Synergy 2 base model. Includes incubation control, shaking, and Gen5 software.
L	Luminescence
F	Fluorescence Intensity, top and bottom. Includes the Tungsten-Halogen light source.
P	Fluorescence Polarization. Requires the “F” module.
T	Time-Resolved Fluorescence. Requires “F” module. Includes the high energy DPR Xenon Flash Lamp.
A	UV-Visible Absorbance (monochromator-based). Includes the SQ Xenon flash lamp.
D	Dual Reagent Dispenser.

BioTek’s Gen5 software is used to control all of the reader’s functions. If the reader is connected and turned on, Gen5 will present you only with options that apply to your reader model. For example, if your model is not equipped with the Dispense module, Gen5 will not provide the option for you to add a Dispense step to your assay protocol.

External Components

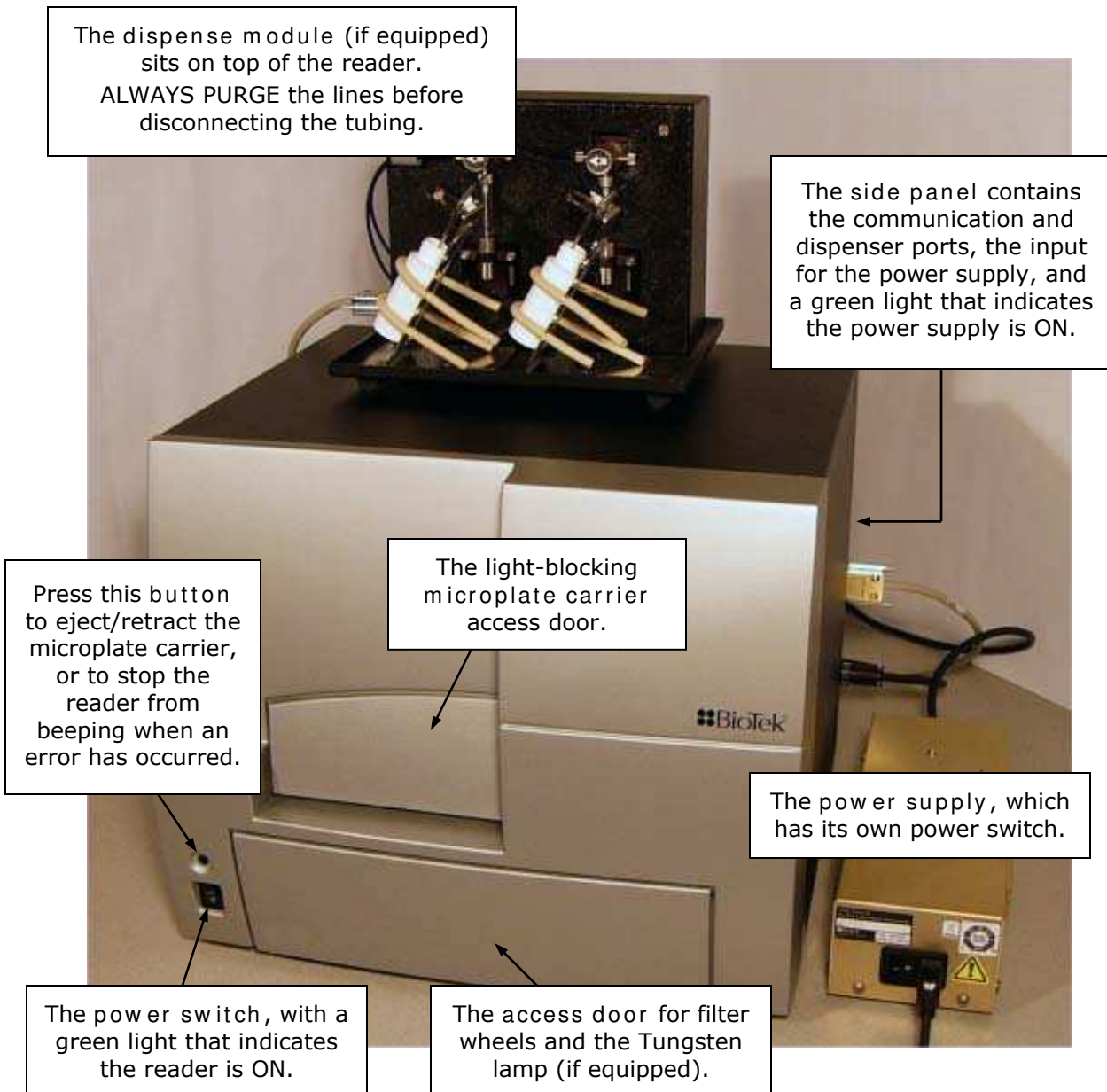

Figure 18: Identifying the main external components

Internal Components

This section introduces some internal components that may require replacement and/or cleaning over time. Each topic provides references to other sections of this manual for more detailed information and instructions. As discussed on page 50, not all of these components exist in all Synergy 2 models.

Component	What you need to know about it	Page
Tungsten Lamp	Requires replacement after approximately 1000 hours of use. Applies to models with the Fluorescence Intensity and/or Fluorescence Polarization modules.	53
Excitation and Emission Filters	The filters and filters wheels can be changed to accommodate your assays, and filters should be cleaned periodically. Applies to models with the Fluorescence Intensity, Fluorescence Polarization, Time-Resolved Fluorescence, and/or Luminescence modules.	54
Mirrors	The mirrors and mirror holder can be changed to accommodate your fluorescence assays. Mirrors may require cleaning over time. Applies to models with the filter-based Fluorescence Intensity, Time-Resolved Fluorescence and Fluorescence Polarization modules.	55
Injector System	The syringes may require replacement over time. The tubing and internal reading chamber may require cleaning over time. Applies to models with the Dispense module.	56

Tungsten Lamp

Description and Location

Synergy 2 models with the Fluorescence Intensity and/or Fluorescence Polarization modules are equipped with a Tungsten lamp. The lamp is accessed through a hinged door on the front of the instrument. To open the door, press on its lower left and right corners until the door opens downward. The lamp is on the left, behind a light shield with a hot surface warning label.



Figure 19: Locating the Tungsten lamp

When to Replace the Lamp

The Tungsten lamp is expected to operate without replacement for a minimum of 1000 hours. The intensity of the bulb will slowly drop over time until the reader's System Test detects a low signal and displays an error message. In addition, error code 2901 may be displayed during normal operation. The lamp should be replaced at this time; contact BioTek and order part number 7080500.

See **Chapter 7, As Needed Maintenance** for replacement instructions.



Keep the front door closed during operation. The intense broad spectrum light of the xenon lamp can cause eye damage. The light shield shown above mitigates the risk.

Excitation/ Emission Filters

Synergy 2 models with the Fluorescence Intensity module are equipped with Excitation and Emission filter wheels. (Models with the Luminescence module without Fluorescence Intensity have an Emission filter wheel only.) The filter wheels are labeled as “EX” or “EM” and are accessed through a hinged door on the front of the instrument. To open the door, press on its lower left and right corners until the door opens downward.

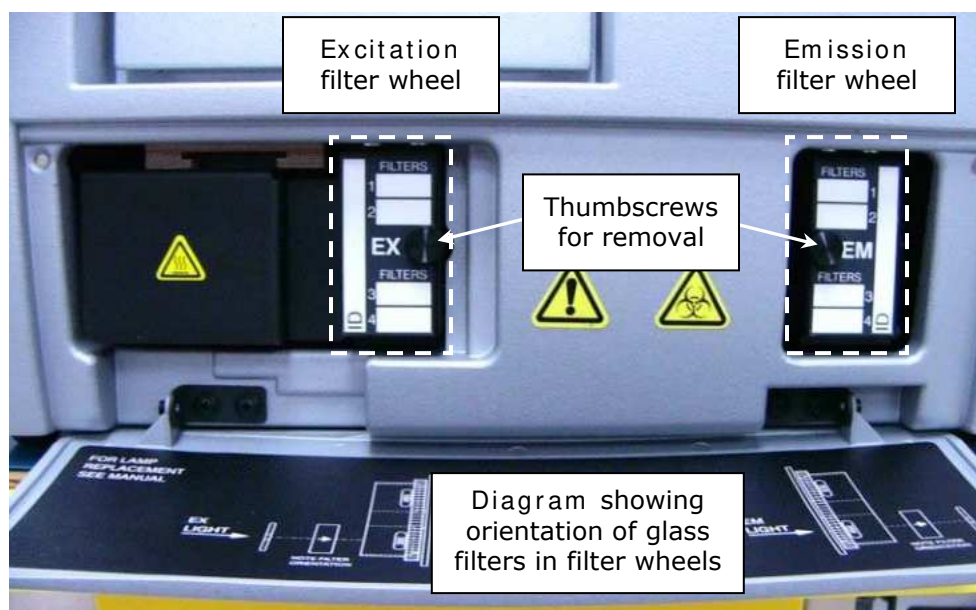

Figure 20: Locating the Excitation and Emission filter wheels

Each filter wheel contains four equal-sized positions. Each position can contain a glass filter or a light-blocking plug, or can be left empty. Filter wheel contents can be changed, as well as entire filter wheels.

Gen5 keeps track of each wheel’s contents, and communicates this information to the instrument during operation. If you make any changes to either filter wheel, you must update Gen5’s filter table (System > Reader Configuration).

See **Chapter 4, Filters and Mirrors** for information on working with the filter wheels, and for a list of filters available from BioTek.

EX/ EM Configuration for Luminescence

- For best results when taking luminescence measurements, the Excitation filter wheel (if equipped) should have no empty locations.
- If your tests require that the light emitted from the samples remain unfiltered, the Emission filter wheel should have an empty location in it. When selecting a filter set for a read in Gen5, selecting ‘Hole’ indicates the empty location.

Mirrors

When taking fluorescence (FI, FP, or TRF) measurements from the top, the Synergy 2 uses mirrors to direct the excitation and emission light paths. The mirrors are stored in a mirror holder, which is a rectangular box located inside the reader. The holder stores up to three mirrors. There are two possible mirror types:

- A 50% mirror is a glass slide with silver dots (see #1 below). It works with any wavelength in the range of 200 to 850 nm.
- A dichroic mirror is wavelength specific; it requires the excitation and emission filters to fall within specific ranges. Dichroic mirrors provide better sensitivity than 50% mirrors, but they are dye-specific.

The default mirror configuration is shown below (any changes should be reflected in your sales order). A 50% mirror is easily identified by its “dots,” and each dichroic mirror is etched or labeled with its wavelength value.

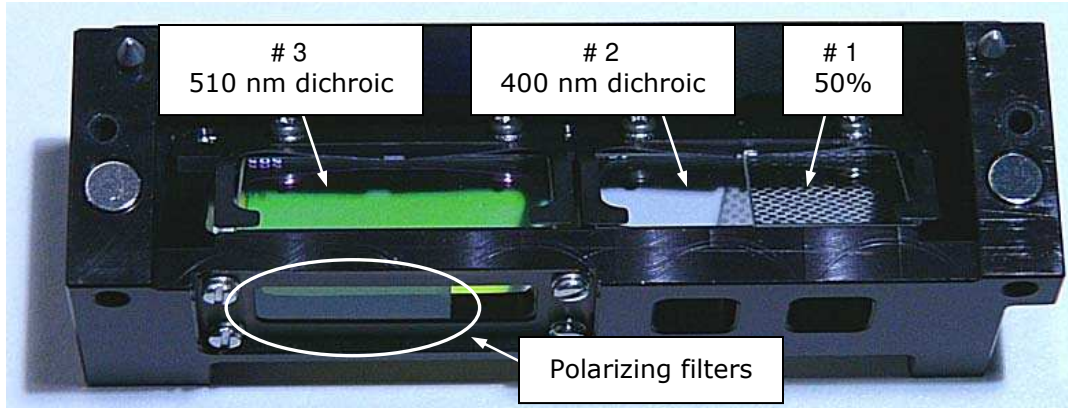

Figure 21: Identifying the mirrors in the mirror holder (default configuration shown). Models with the Fluorescence Polarization module also have EX polarizing filters in the mirror holder, as shown inside the oval above.

The entire mirror holder and the individual mirrors are user-changeable. Because the mirrors can be easily smudged or even damaged, however, BioTek strongly recommends changing the entire mirror holder. Contact BioTek for more information on purchasing additional mirrors and holders.

To learn more about how mirrors are used, and how to change or clean them, see **Chapter 4, Filters and Mirrors**.

Injector System

External Dispense Module

❖ If a syringe is leaking, it may need to be replaced. See Chapter 7, As Needed Maintenance for instructions.



Each dispense module is calibrated to perform with a specific Synergy 2 reader. Make sure the same serial number appears on both the dispense module and the reader.

The dispense module pumps fluid from the supply bottles to injector heads located inside the instrument. Fluid is injected into one well at a time.

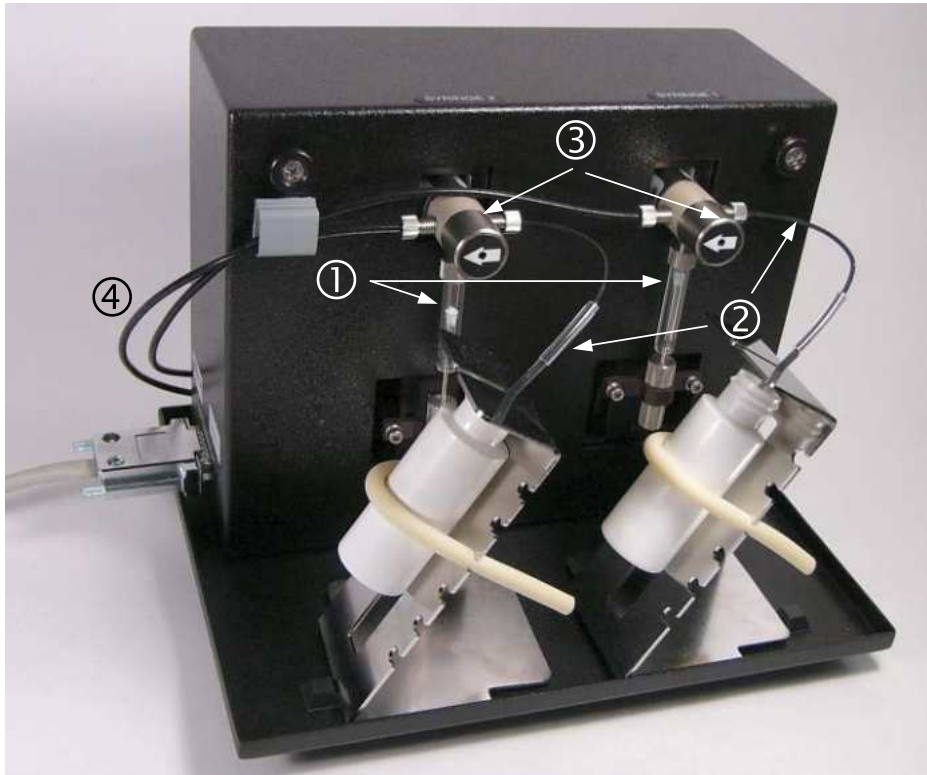

Figure 22: Dispense module components

- 1 Two 250- μ L syringes draw fluid from the supply bottles.
- 2 Inlet tubes transport fluid from the supply vessels to the syringes. These tubes are short pieces of opaque PTFE (Teflon) tubing connected to stainless steel probes on one end and threaded fittings on the other end.
- 3 Three-way valves switch the syringe flow from the inlet tubes to the outlet tubes.
- 4 Outlet tubes transport fluid from the syringes into the instrument, through the tubing ports on the reader's rear panel. The outlet tubes are opaque PTFE tubes with threaded fittings on each end that are used to deliver fluid from the syringes to the instrument.

Internal Tubing

Inside the reader, two Teflon tubes transport fluid from the tubing ports on the rear of the instrument to the two injectors. As shown below, both injectors are positioned directly above the bottom fluorescence optical probe.

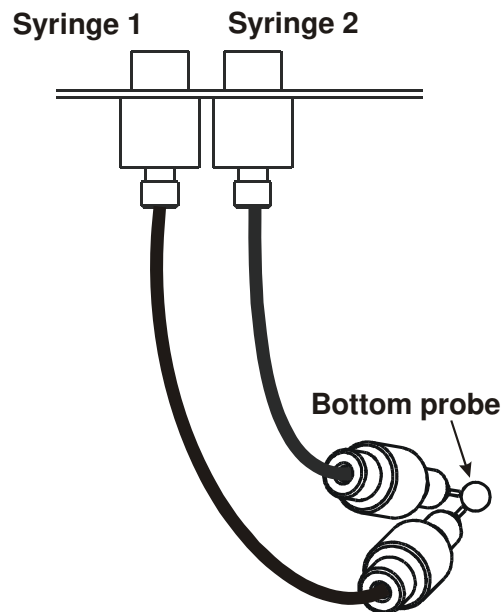

Figure 23: Injectors inside the reader

- ❖ The tubing and injectors should be cleaned at least quarterly. See Chapter 6, Preventive Maintenance for more information.

Priming the Injector System

Before running a Dispense assay, prime the system with the reagent or dispensing fluid. Additionally, tip priming can be performed at the start of the assay and sometimes, just before each dispense to a well. The tip prime compensates for any fluid loss at the injector tip due to evaporation since the last dispense. All priming activities are controlled via Gen5.

Both types of primes require a fluid reservoir to be present on the microplate carrier:

- The priming plate is placed on the microplate carrier for a Prime operation (to prime the dispense system with fluid).
- The tip priming trough is a small, removable cup located in the left rear of the carrier, and is used for performing the Tip Prime before dispensing. The trough holds up to 1.5 mL of liquid and must be periodically emptied and cleaned by the user.

❖ Do not perform Tip Priming when using tall plates. Generally, plates with fewer than 96 wells are too tall for error-free tip priming; and, tip priming is rarely required for these larger-volume plates.

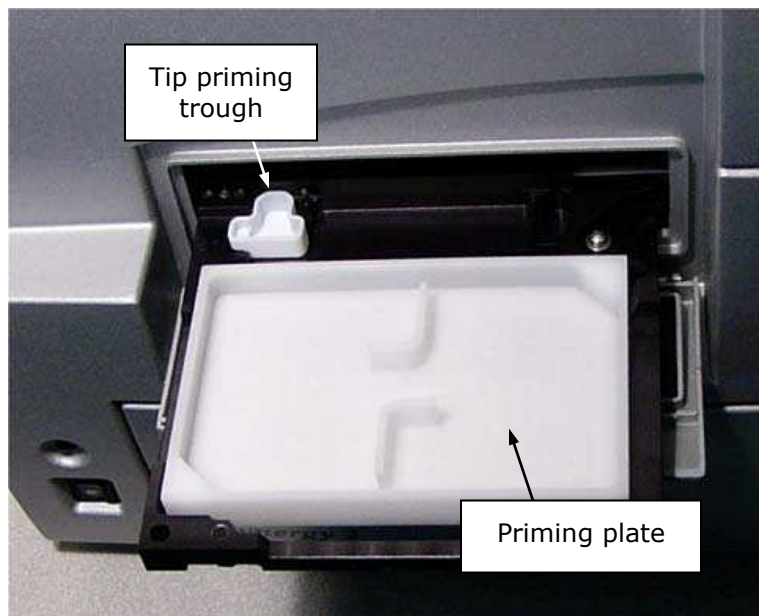

Figure 24: The tip priming trough and priming plate installed on the microplate carrier

Gen5 Software

BioTek Gen5 software supports all Synergy 2 reader models. Use Gen5 to control the reader and the dispense module (if equipped), perform data reduction and analysis on the measurement values, print / export results, and more.

This section provides brief instructions for working with Gen5 to define the contents of filter wheels and mirror holders, create protocols and experiments, and read plates. Refer to the Gen5 Help system for more information.

Define Excitation/ Emission Filters

For models equipped with Excitation and Emission filter wheels, the reader's onboard software is configured with the filter values and their locations in the filter wheels. When Gen5 communicates with the reader, it requests this information and stores it in a filter table on the computer. If you make any changes to the filter wheels, you must define the changes in Gen5 and send the information to the reader.

To access the filter wheel information in Gen5:

- Select System > Reader Configuration. Highlight the Synergy 2 reader, and click View / Modify.
- Click Setup and then click the Fluorescence/ Luminescence or Absorbance tab. Refer to the Gen5 help system for additional instructions.

Define Mirrors

For models equipped with a mirror holder, the reader's onboard software is configured with the mirror types and their characteristics. When Gen5 communicates with the reader, it requests this information and stores it in a mirror table on the computer. If you change any mirrors, you must define the changes in Gen5 and send the information to the reader.

To access the mirror holder information in Gen5:

- Select System > Reader Configuration. Highlight the Synergy 2 reader, and click View / Modify.
- Click Setup and then click the Mirrors tab. Refer to the Gen5 help system for additional instructions.

Protocols and Experiments

In Gen5, a **Protocol** contains instructions for controlling the reader and (optionally) instructions for analyzing the data retrieved from the reader. At a minimum, a protocol specifies the Procedure for the assay you wish to run. After creating a protocol, you can create an **Experiment** that references the protocol. You can then run the experiment to read plates and analyze the data.

The instructions below briefly describe how to create a simple **protocol** in Gen5. See the Gen5 Help system for complete instructions.

1. Select **File > New Protocol**.
2. Open the **Procedure** dialog. If prompted to select a reader, select the Synergy 2 and click **OK**.
3. Add steps to the procedure for shaking or heating the plate, dispensing fluid, reading the plate, and more. Click **Validate** to verify that the reader supports the defined steps, and then click **OK**.

Optionally, perform the next steps to analyze and report the results:

4. Open the **Plate Layout** dialog and assign blanks, samples, controls, and/or standards to the plate.
5. Open the **Data Reduction** dialog to add data reduction steps. Categories include Transformation, Well Analysis, Curve Analysis, Cutoff, Fluorescence Polarization and Validation.
6. Create a report or export template, via the **Report Builder**, **File Export Builder**, or **Power Export Builder** options.
7. Select **File > Save** and give the protocol file an identifying name.

The instructions below briefly describe how to create a simple **experiment** and then read a plate in Gen5. See the Gen5 Help system for complete instructions.

1. Select **File > New Experiment**.
2. Select the desired protocol and click **OK**.
3. Highlight a plate in the menu tree and click **Read**. The **Plate Reading** dialog will appear.
4. Click **READ**. The door will open and the carrier will extend (if it is not already extended).
5. Place the plate on the carrier and click **OK** to begin the read.
6. When the read is complete, measurement values will appear in Gen5. Use the **Plate View** to view the results. (Double-click a plate in the menu tree to open the **Plate View**.) Select the desired data set (e.g., "528/20,645/40") from the **Data list**.
7. Select **File > Save** and give the experiment file an identifying name.

Dispense Module Control

This section only applies to models with injectors.

Gen5 is used to perform several dispense module-specific functions, such as initialize, dispense, prime, and purge. The Prime and Purge functions are introduced here. See the Gen5 help system for more information.

❖ Priming and purging routines are used to clean the fluid path; see also “Flush/Purge the Fluid Path” on page 143.

Prime

Before running a procedure with a Dispense step, prime the system with the fluid to be used:

1. **I m p o r t a n t !** Place the priming plate on the carrier.
2. Fill the supply bottle with a sufficient volume of the fluid to be used for the prime and the assay. Insert the appropriate inlet tube into the bottle.
3. In Gen5, select **System > Reader Control > Synergy 2 (Com < # >)** and click the **Dispenser** tab.
4. Select the **Dispenser** number (1 or 2) associated with the supply bottle.
5. Enter the **Volume** to be used for the prime. The minimum recommended prime volume is 1000 μL .
6. Select a **prime Rate**, in $\mu\text{L}/\text{second}$.
7. Click **Prime** to start the process.
8. When finished, carefully remove the priming plate from the carrier and empty it.

❖ If the priming plate is empty, the prime volume was too low.

Purge

To save reagent, Gen5 provides a method to purge fluid from the system back into the supply bottle:

1. In Gen5, select **System > Reader Control > Synergy 2 (Com < # >)** and click the **Dispenser** tab.
2. Select the **Dispenser** number (1 or 2) associated with the supply bottle.
3. Enter the desired **purge Volume** in μL .
4. Select a **prime Rate** in $\mu\text{L}/\text{second}$.
5. Click **Purge** to start the process.

Recommendations for Optimum Performance

Microplates should be clean and free of dust or bottom scratches. Use new microplates from sealed packages. Do not allow dust to settle on the surface of the solution; use microplate covers or seals when not reading the plate. Filter solutions to remove particulates that could cause erroneous readings.

Before preparing your microplates, make sure the reader is on and communicating with Gen5. You may want to run a System Test if the reader has not been turned off/on in a few days. Design your Gen5 protocol in advance as well, to ensure that the intended reading parameters are used and to avoid any last-minute corrections.

Although the Synergy 2 supports standard flat, U-bottom, and V-bottom microplates, the reader achieves optimum performance with flat-bottomed wells. See **Appendix A Specifications** for information on supported plates.

Non uniformity in the optical density of the well bottoms can cause loss of accuracy, especially with U- and V-bottom polyvinyl microplates. Check for this by reading an empty microplate. Dual wavelength readings can eliminate this problem, or bring the variation in density readings to within acceptable limits for most measurements.

Inaccuracy in pipetting has a large effect on measurements, especially if smaller volumes of liquid are used. For best results, use at least 100 μL per well in a 96-well plate, 25 μL in a 384-well plate and 5 μL in a 1536-well plate.

Pipetting solution into 384- and 1536-well plates often traps air bubbles in the wells, which may result in inaccurate readings. A dual-wavelength reading method usually eliminates these inaccuracies. However, for best results, remove the air bubbles by degassing the plate in a vacuum chamber or spinning the plate in a centrifuge before reading.

The inclination of the meniscus can cause loss of accuracy in some solutions, especially with small volumes. Agitate the microplate before reading to help bring this problem within acceptable limits. Use Tween® 20, if possible (or other wetting agent) to normalize the meniscus for absorbance measurements. Some solutions develop menisci over a period of several minutes. This effect varies with the brand of microplate and the solution composition. As the center of the meniscus drops and shortens the light path, the density readings change. The meniscus shape will stabilize over time.

To keep the dispense system in top condition, flush and purge the fluid lines with deionized (DI) water every day or upon completion of an assay run, whichever is more frequent. Some reagents may crystallize or harden after use, clogging the fluid passageways. Flushing the tubing at the end of each day, letting the DI water soak them overnight, and then purging the lines at the beginning of each day ensures optimal performance of the dispense system. See **Chapter 6, Preventive Maintenance** for more information.

Models with injectors: When dispensing volumes less than or equal to 20 μL /well, BioTek recommends specifying a tip prime volume equal to the dispense volume. For dispense volumes greater than 20 μL /well, BioTek recommends a tip prime volume of 20 μL .

Chapter 4

Filters and Mirrors

Chapter 3 provided an overview of the filters and mirrors installed in Synergy 2 models with the Fluorescence Intensity module. This chapter provides more detailed information on working with these components.

Excitation/Emission Filters	64
Change the Filter Wheels and Filters	65
Clean the Filters	66
Filters Available from BioTek	67
Mirrors	68
Change the Mirror Holder and Mirrors	71
Clean the Mirrors	76
Mirrors Available from BioTek	77

Excitation/ Emission Filters

The Synergy 2 is equipped with filter wheels for use with obtaining fluorescence and luminescence measurements. The Excitation filter selects the band of light to which the sample will be exposed. The Emission filter selects the band of light with the maximum fluorescence signal of the sample, to be measured by the photomultiplier tube (PMT).

The filter wheels are accessed by opening the hinged door on the front of the reader.



Figure 25: Accessing the Excitation (EX) and Emission (EM) filter wheels

Each filter wheel is labeled as EX or EM, and can contain up to four filters and/or black plugs (also referred to as “dummy filters”). Each filter has its central wavelength and band pass values printed on its side, with an arrow to indicate the proper direction of light through the filter (see **Figure 26**). Filters and plugs are secured with C-clip retainers.

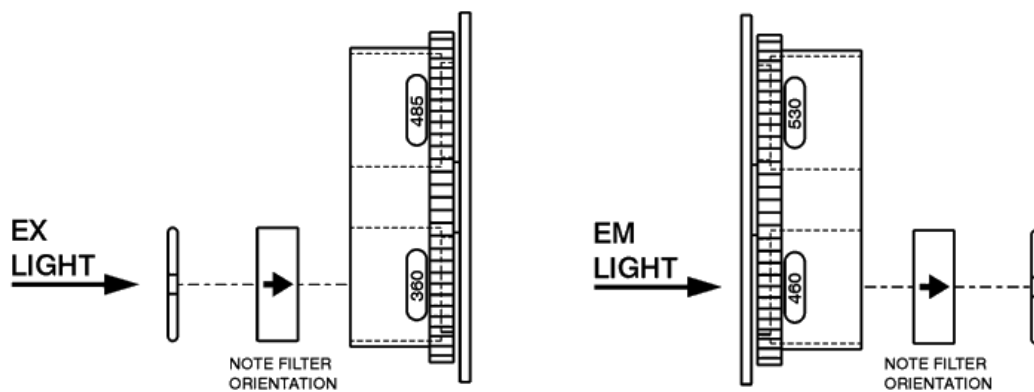

Figure 26: EX and EM filter wheels, showing correct orientation of the filters

Change the Filter Wheels and Filters

The filter wheels are easily exchanged to meet your assay requirements. If you regularly need to change the filters on the reader, consider purchasing additional filter wheels from BioTek to make the process easier and faster.

As shown in **Figure 25**, labels on the front of the filter wheels can be marked with the central wavelength and band pass of each filter.

When removing/replacing filter wheels:

- It is critical that the Gen5 Filter Table matches the actual filter locations in the EX and EM filter wheels. See “Define Excitation/Emission Filters” on page 59.
- The Excitation and Emission filter wheels are not interchangeable and are labeled EX = Excitation, EM = Emission.
- Filter direction within each filter wheel is important, and the direction differs depending on the filter wheel type. A diagram on the inside of the reader’s front panel door indicates orientation; see **Figure 26**.
- Each filter is marked with an arrow indicating the correct direction of light through the filter. Filters are not specific to either excitation or emission.

To remove a filter wheel:

1. Using your thumbs, push down on the bottom corners of the hinged door on the front of the reader to open the door.
2. Observe the two thumbscrews within the compartment. The left thumb-screw secures the Excitation filter wheel; the right secures the Emission filter wheel.
3. Remove the thumbscrew and slide the filter wheel’s supporting metal bracket straight out of the compartment.

❖ The Emission filter wheel “springs” out when removed (a shutter behind the wheel closes quickly to protect the PMT).

To install a filter wheel:

1. Ensure that all filters and/or plugs are inserted properly (see **Figure 26**).
2. Slide the filter wheel into its chamber.
3. Replace the thumbscrew and close the front door.
4. Use Gen5 to update the reader’s internal software with the current filter wheel configuration; see “Define Excitation/Emission Filters” on page 59.



When removing or replacing a filter or C-clip retainer, do not use a sharp object. Use several layers of lens paper and your finger to remove and replace filters and clips. Using a sharp object, such as a flat screwdriver, will scratch the filter surface and make it unusable. Do not touch the filters with your bare fingers.

To remove a filter or plug:

1. Remove the filter wheel as instructed on the previous page.
2. Turn the filter wheel to align the desired filter with the hole in the supporting bracket.
3. Place the bracket on a flat surface, with the filter wheel facing down.
4. Prepare a multi-layered “cushion” of lens paper. Using your finger covered with the lens paper, gently push against the filter and its retainer until they pop out.

To replace a filter or plug:

1. Hold the metal bracket with the filter wheel facing up.
2. Orient the filter or plug (see **Figure 26**): Observe the arrow on the filter indicating the light direction. Align the filter’s wavelength number with the window in each filter holder, then drop it into the desired location.

❖ Make note of the filter position number, 1–4.

3. Using your fingers, squeeze the sides of the C-clip retainer, and then insert it into the top of the hole containing the new filter. Cover your finger with several layers of lens paper, and then push down on all sides of the retainer until it sits flush against the filter.
4. Gently wipe both sides of the filter with lens paper.
5. When finished, install the filter wheel.

Clean the Filters

Instructions are provided in **Chapter 6, Preventive Maintenance**.

Filters Available from BioTek

Bandpass filters are available for purchase from BioTek. Please note that part numbers are subject to change, and new filters may become available. Custom filters are also available. Contact BioTek Customer Care with any questions.

PN	Wavelength	Main Application
7082259	284/10	Tryptophan excitation
7082248	310/20	Tyrosine emission, O-aminobenzoyl excitation
7082250	320/20	7-methoxycoumarin and Quanta Blu excitation
7082263	330/80	HTRF excitation
7082254	340/11	Fura-2 excitation
7082230	340/30	NADH excitation and tryptophan emission
7082220	360/40	MUB, caspase-3, europium chelate excitation
7082228	380/20	Fura-2 and EBFP excitation
7082242	400/10	
7082205	400/30	Porphyrin excitation, O-aminobenzoyl and 7-methoxycoumarin emission
7082206	420/50	CFP excitation and Quanta-Blu emission
7082227	440/30	Attosphos excitation and caspase-3 emission
7082207	440/40	NADH emission
7082208	450/50	CBQCA excitation
7082222	460/40	NanoOrange excitation and EBFP and MUB emission
7082221	485/20	Fluorescein, EGFP excitation and CFP emission
7082209	485/40	Propidium Iodide excitation
7082256	500/27	YFP excitation
7082218	508/20	Fura-2 emission
7082246	516/20	EGFP emission
7082247	528/20	VIC excitation and Fluorescein and EGFP emission
7082223	530/25	5-Tamra excitation
7082249	540/25	Alexa Fluor 546, CY3, and rhod2 excitation and EYFP emission
7082253	540/35	Alamar Blu, Amplex red, RFP excitation
7082210	545/40	Rhodamine B excitation
7082215	560/15	Cell Titer Blue excitation
7082211	560/20	VIC emission
7082212	560/40	Attosphos and CBQCA emission
7082264	570/100	AlphaScreen emission
7082245	575/15	ROX excitation and CY3 and 5-Tamra emission
7082244	580/50	NanoOrange and Attosphos emission
7082225	590/20	Alexa Fluor 594 and Texas Red excitation and Cell Titer Blue emission
7082224	590/35	Rhod-2, Alexa Fluor 546, and CY3 emission
7082252	600/40	Alamar Blu, Amplex Red, RFP and porphyrin emission
7082265	620/10	HTRF / LANCE emission
7082251	620/15	ROX and Alexa Fluor 594 emission and Alexa Fluor 633 excitation
7082213	620/40	Rhodamine B, europium chelate emission, CY5 excitation
7082214	635/32	Texas Red emission
7082257	645/15	Alexa Fluor 633 emission
7082266	665/7.5	HTRF / LANCE emission
7082226	645/40	Texas Red and Propidium iodide emission
7082229	680/30	CY5 emission, AlphaScreen excitation

The fluorescence ratio associated with the HTRF readout is a correction method developed by CIS bio and covered by the US patent 5,527,684 and its foreign equivalents, for which CIS bio has granted a license to BioTek. Its application is strictly limited to the use of HTRF reagents and technology, excluding any other TR-FRET technologies.

Mirrors

❖ See also “Mirrors” on page 55.

For top-reading fluorescence analysis, the Synergy 2 uses mirrors to direct the excitation and emission light paths. Mirrors are required for fluorescence polarization (FP) measurements to direct light to the sample, because fibers cannot carry polarized light. Mirrors also provide increased sensitivity for fluorescence intensity (FI) and time-resolved fluorescence (TRF) measurements when compared to mapped fiber optics.

Mirrors are stored in a three-mirror holder (additional mirror holders and mirrors can be purchased as accessories). The holder and individual mirrors can be changed to meet your requirements. You can replace the entire holder with a different one; this is the BioTek recommended option. Alternatively, you can install different mirrors in the holder. Contact BioTek for more information on purchasing mirrors and holders.

For Synergy 2 models with the FP module, the reader is equipped with three polarizers:

- Excitation polarizer (visible-range or UV-range, see page 70)
- Emission polarizer, parallel to excitation polarizer
- Emission polarizer, perpendicular to excitation polarizer

Inside the reader, the mirror holder is labeled with five position numbers (see **Figure 27** on the next page), which translate to three possible measurement positions (see **Figure 28**).

The third measurement position is dedicated to FP, because it holds the polarizers. It is twice the size of positions 1 and 2, and it is numbered 3, 4, 5 in the reader. Gen5 recognizes only the three measurement positions. FI and TRF can be performed using position 3 as well. See **Figure 29** for a close-up view of measurement position 3.

When running an experiment, Gen5 communicates with the reader to move the holder to the proper position based on the mirror you define in a Read step in the Gen5 protocol.

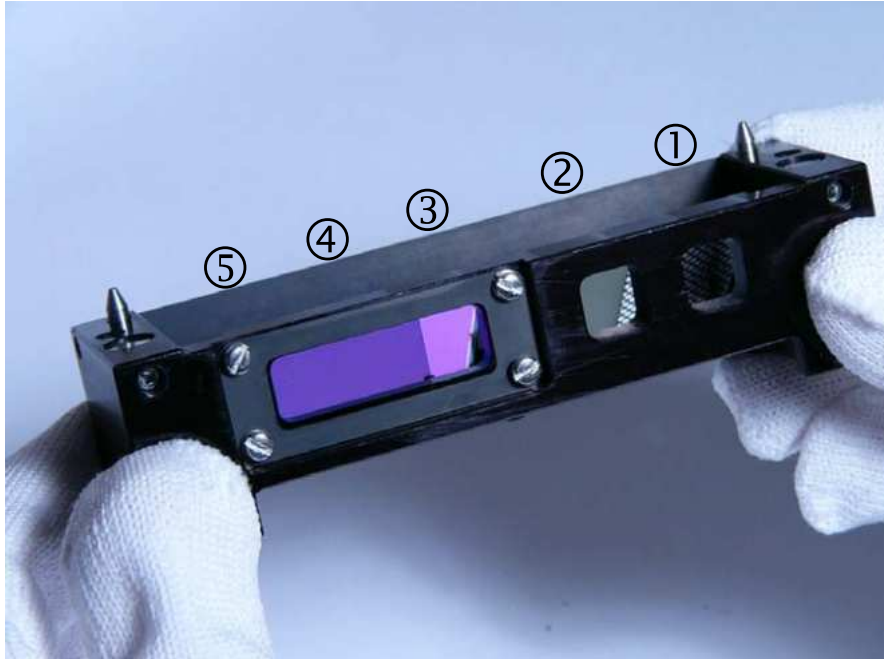

Figure 27: Mirror holder removed from the reader

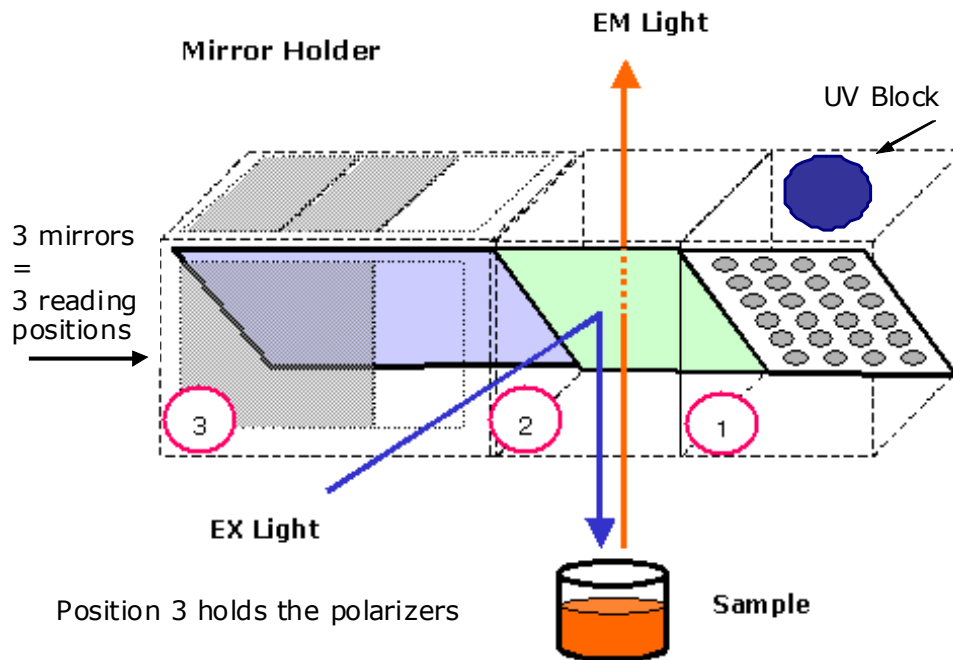

Figure 28: Mirror holder diagram; the three reading positions are indicated

❖ Position 1 in the mirror holder has an emission UV-blocking filter. It transmits light above 380 nm and blocks light below 360 nm. If you are using a 50% mirror and an excitation above 360 nm, for best results place the 50% mirror in position 1 (the default location). If emission of your assay is below 380 nm, do not use position 1 for these measurements; move the 50% mirror to position 2.

❖ Models with the FP module: The polarizers are always installed in positions 4 and 5, which translates to Mirror #3 in Gen5.

This diagram shows **Position 3** in the mirror holder. It holds the polarizer filters required for Fluorescence Polarization.

It is the only mirror position that can be selected for an FP read.

It can also be selected for FI and TRF, also, which use the open positions.

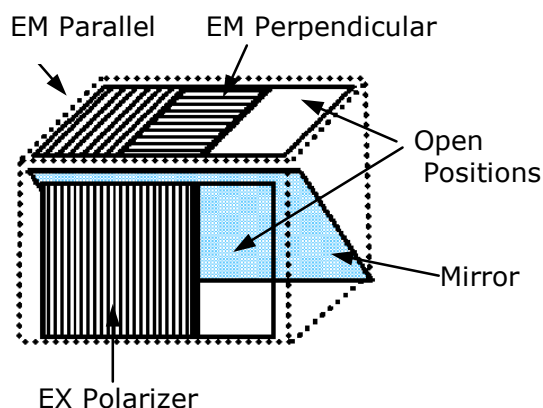

Figure 29: Mirror holder; Position 3 diagram

Two types of excitation (EX) polarizers are available: visible-range (400 nm and above, the default) or UV-range (300 nm and above, available from BioTek). The visible-range polarizer's bracket is etched with "400 nm". The emission (EM) polarizers are installed inside the reader, in the mirror holder's top plate.

The default mirror holder configuration is described here; your reader may be configured differently. Turn to page 77 for a list of mirrors available from BioTek.

Position #	Mirror #	Mirror Type	Polarizers	EX Range (nm)	EM Range (nm)	Use
1	1	50%	None	200–850	200–850	FI, TRF
2	2	400 nm Dichroic	None	320–390	410–800	FI, TRF
3	3	510 nm Dichroic	None	440–505	515–640	FI, TRF
4			EX (visible-range), parallel EM			FP
5			EX (visible-range), perpendicular EM			

Change the Mirror Holder and Mirrors

- ❖ Do not touch the mirrors. These optical elements are delicate and must be handled carefully. The glass and anti-reflective (AR) coated surfaces are damaged by any contact, especially by abrasive particles. Wear cloth gloves to reduce the risk of damaging the mirrors and polarizing filters. For cleaning instructions see Chapter 7, Preventive Maintenance.

Because dichroic mirrors are wavelength specific, it may be necessary to change the mirror holder before performing certain assays. BioTek offers additional mirror holders and mirrors as separate accessories.

Mirrors and polarizing filters are easily damaged. If more than three unique mirrors are used in your lab, the preferred method is to use multiple mirror holders, which can be exchanged as needed. BioTek offers additional mirror holders and mirrors as separate accessories.

Removing the mirror holder from the reader is required in either scenario. Before removing the holder, take a moment to identify the reader's components that are described in the following procedures.

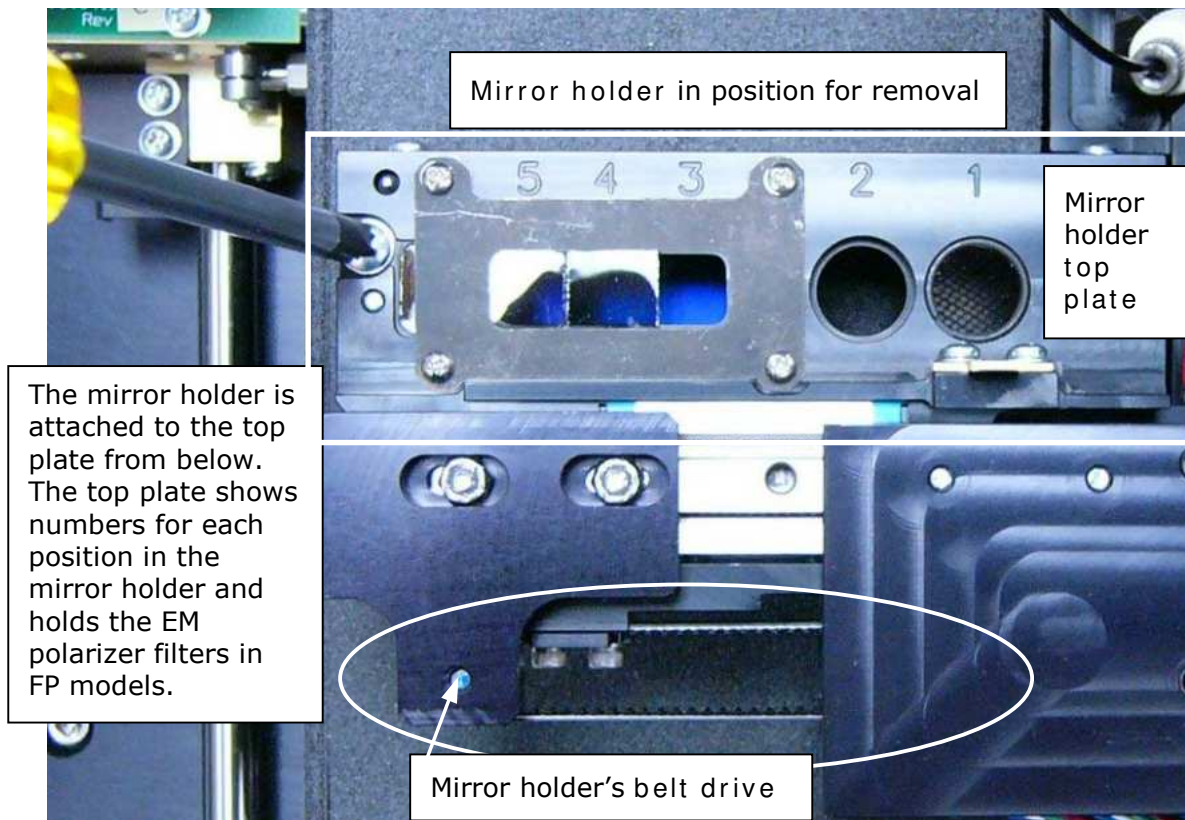

Figure 30: Mirror holder positioned for removal

To remove the mirror holder

1. Turn off the reader and remove its shroud (see instructions on page 147).
2. The mirror holder will likely be stored in its “home” position; you’ll need to move it to an accessible position. Use the holder’s belt drive (see below) to roll the holder (to the left) away from the optics armature. Use your thumb to turn the belt counterclockwise.

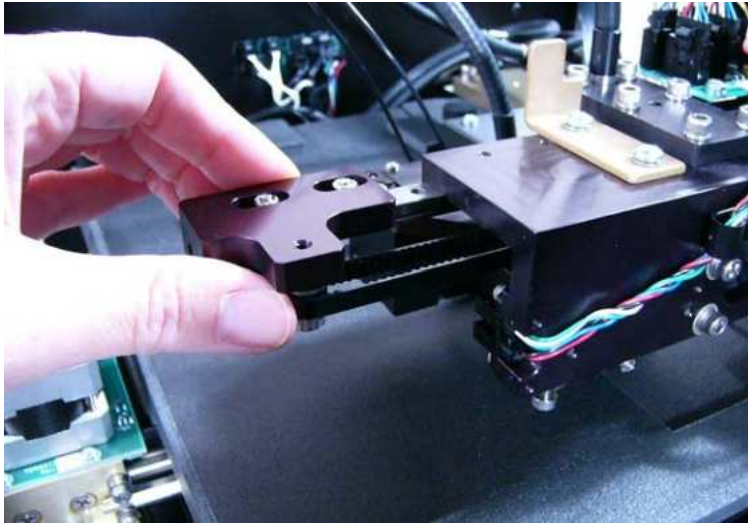

Figure 31: Turn the belt drive to position the holder for removal

3. When the mirror holder is fully exposed, carefully remove the two screws and washers on top, and set them aside. The holder will continue to be held in place by its magnetized frame.
4. Grasping the sides of the holder underneath the top plate, pull the holder down and toward the back of the reader to remove it.

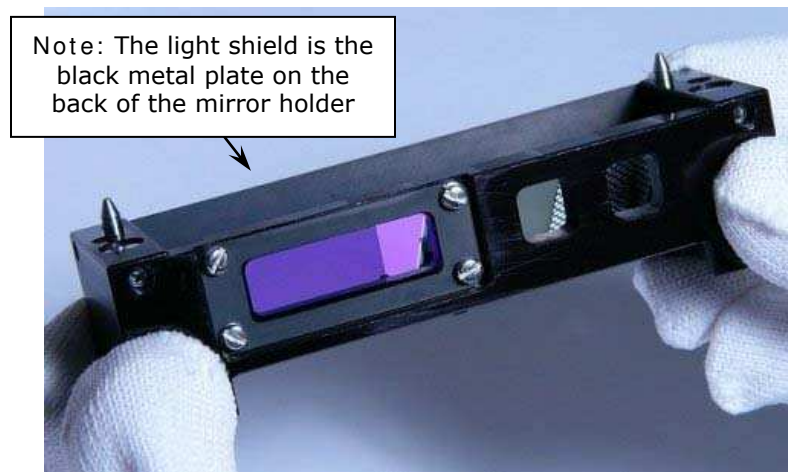

Figure 32: Mirror holder removed from the reader

5. When you change the holder, update Gen5 with the new mirror configuration:
 - Select System > Reader Configuration.
 - Double-click the Synergy 2 reader to open the Reader Settings dialog.
 - Click Set up.
 - Select the Mirrors tab.
 - For each Mirror position, 1, 2, 3, use the drop-down list to select the Type of mirror. For dichroic mirrors, enter the excitation and emission wavelength ranges. (Refer to the Gen5 help for more information.)

- ❖ It is critical the Gen5 mirror table reflects the actual location and characteristics of the mirrors in the reader.
- ❖ If you accidentally touch the mirrors or polarizing filters, see Chapter 7, Preventive Maintenance for cleaning instructions.

To change a mirror in the mirror holder

Use these tools to change a mirror:

- Linen or cloth gloves
- Small Phillips screwdriver

- ❖ Touch the mirrors as little as possible; hold them by their edges only. The mirrors are easily damaged.

1. Remove the mirror holder from the reader.
2. The holder has a light shield to protect the mirrors (**Figure 33**). Use a Phillips screwdriver to remove the four screws and washers that attach this shield to the holder.
3. Use the Phillips screwdriver to remove the bracket that secures the mirrors (**Figure 34**). Set aside the screws. Lift the bracket away from the holder and set aside.
4. Grasping the mirror by its edges, remove it from the holder and store it properly.
5. Holding the replacement mirror by its edges, turn the mirror so its label is face-up and readable. Align it in this orientation when you insert it into the holder.
6. Replace the metal bracket to secure the mirror. The bend in the bracket's arms should point away from the holder.
7. When you change the mirrors, update Gen5 with the new mirror configuration.

- ❖ It is critical that the Gen5 Mirror Table reflects the actual location and characteristics of the mirrors in the reader.
- ❖ If you accidentally touch the mirrors or polarizing filters, see Chapter 7, Preventive Maintenance for cleaning instructions.
- ❖ The light shield only fits the holder one way. Check its alignment when reattaching it to the mirror holder.



Figure 33: Remove the light shield from the mirror holder

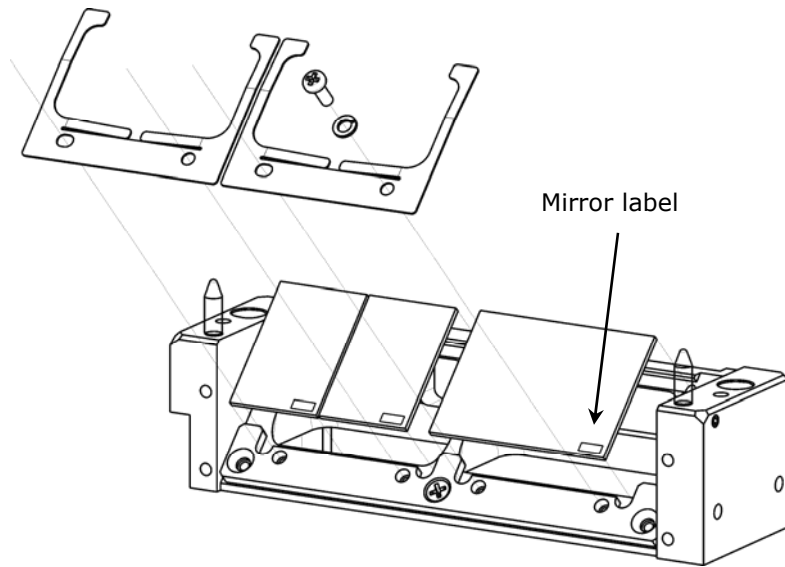

Figure 34: Mirror orientation; labels are face-up and readable

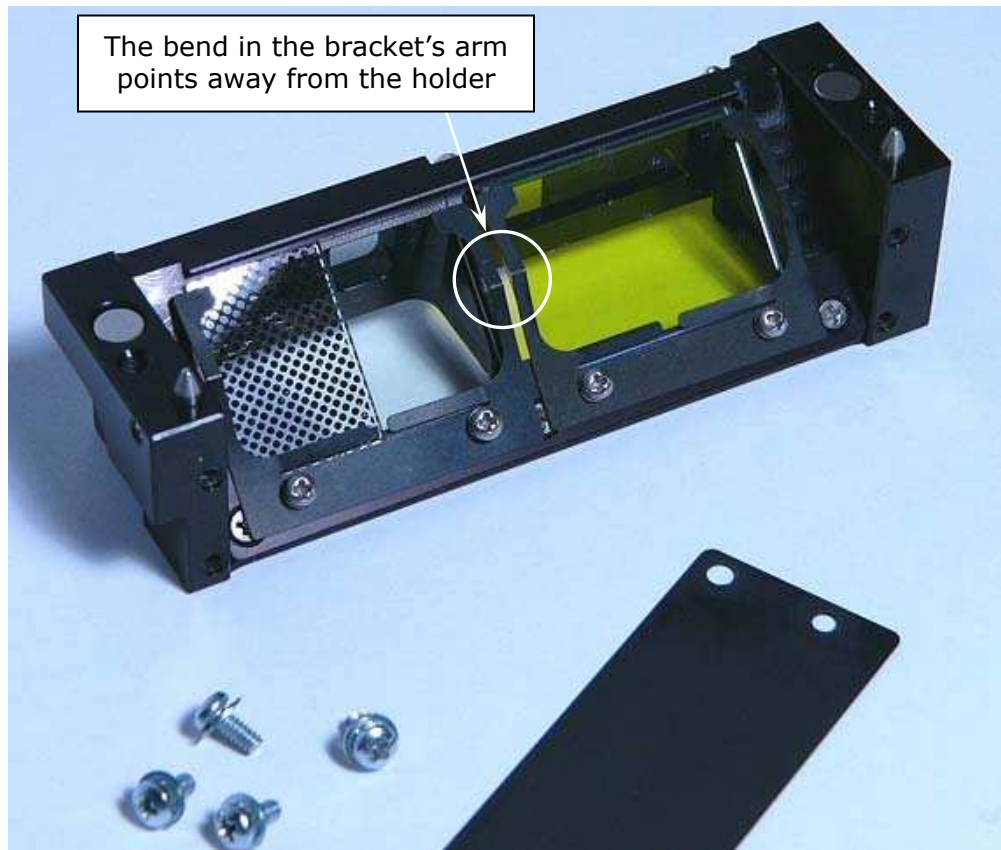

Figure 35: Mirror holder with the light shield removed

To reinstall the mirror holder

1. Hold the mirror holder with the alignment pins on top and the filter windows facing you. This is the holder's orientation inside the reader.
2. Inside the reader, put the mirror holder underneath its top plate (see **Figure 30**). The holder's alignment pins will help guide it into place and because it is magnetized the holder will stay in place.
3. Reinstall the two sets of screws and washers that secure it in the reader.

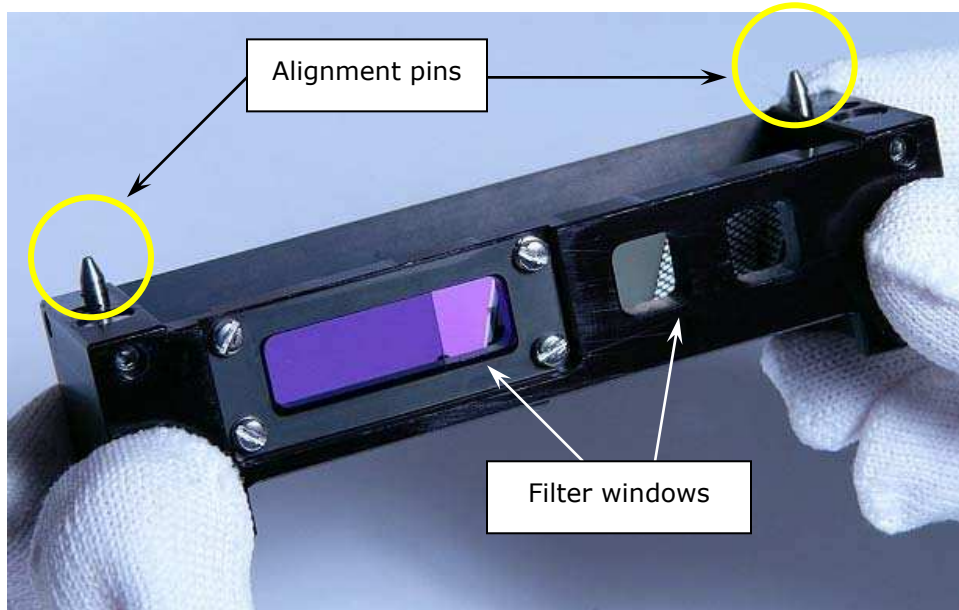

Figure 36: Mirror holder positioned for reinstallation

Clean the Mirrors

Instructions for cleaning the mirrors and polarizers (if equipped) are provided in **Chapter 7, Preventive Maintenance**.

Mirrors Available from BioTek

Please note that part numbers are subject to change, and new mirrors may become available. Contact BioTek Customer Care with any questions.

- Half-Size mirrors fit into positions 1 and 2 of the mirror holder
- Full-Size mirrors fit into position 3.

Half-Size Part #	Full-Size Part #	Cut-off (nm)	Excitation Range	Emission Range	Main Applications
7132121	n/a	50%	200–850	200–850	All except FP
7138365	n/a	365	290–350	380–800	HTRF, MMP, Quanta Blu
7138400	7137400	400	320–390	410–800	MUB, Europium, Hoechst 33258
7138455	7137455	455	400–450	460–710	Attophos, CFP, Fluo-3
7138510	7137510	510	440–505	515–640	Fluorescein, Picogreen, FAM
7138525	7137525	525	475–520	530–670	Rhodamine 123, YFP
7138550	7137550	550	415–540	560–850	CY3, HEX, Rhodamine 6G
7138570	7137570	570	515–565	575–735	Alamar Blu, Amplex Red, TAMRA
7138595	7137595	595	540–590	600–770	ROX, Texas Red
7139635	n/a	635	640–780	400–630	AlphaScreen
7138660	7137660	660	580–655	665–850	CY5

Chapter 5

Instrument Qualification

This chapter contains procedures for qualifying the initial and ongoing performance of the Synergy 2 and the external dispense module (if used).

Overview	80
IQ/OQ/PQ.....	80
Recommended Qualification Schedule	82
System Test.....	83
Absorbance Plate Test	87
Absorbance Liquid Tests	92
Fluorescence Liquid Tests.....	99
Luminescence Test.....	119
Dispense Module Tests	124

Overview

This chapter contains BioTek Instruments' recommended Installation Qualification (IQ), Operational Qualification (OQ), and Performance Qualification (PQ) procedures for the Synergy 2.

Every Synergy 2 reader and external dispense module is fully tested at BioTek prior to shipment and should operate properly upon initial setup. If you suspect that a problem occurred during shipment, if you have received the equipment after returning it to the factory for service, and/or if regulatory requirements dictate that you qualify the equipment on a routine basis, you should perform the procedures outlined in this chapter.

❖ A Product Qualification Package (PN 7130566) for the Synergy 2 is available for purchase. The package contains complete procedures for performing Installation Qualification, Operational Qualification, Performance Qualification, and Preventive Maintenance. Gen5 protocols with embedded Microsoft® Excel spreadsheets are provided for performing the tests and analyzing results. Checklists, data sheets, and logbooks are also provided. Contact your local BioTek dealer for more information.

IQ/ OQ/ PQ

Installation Qualification confirms that the reader and its components have been supplied as ordered and ensures that they are assembled and configured properly for your lab environment.

- The recommended IQ procedure consists of setting up the instrument and its components as described in **Chapter 2, Installation**, and performing the System Test. For models with injectors, a quick "Injector Test" is also performed, to ensure that the dispense module is properly installed and there are no leaks.
- The IQ procedure should be performed **initially** (before the reader is used for the first time).
- The successful completion of the IQ procedure verifies that the instrument is installed correctly. The Operational Qualification procedure should be performed immediately following the successful IQ.

Operational Qualification confirms that the equipment operates according to specification initially and over time.

- The recommended OQ procedure consists of performing the System Test, Absorbance Plate Test, a series of Liquid Tests, and, if the external dispense module is used, the Dispense Accuracy and Precision Tests.
- Your facility's operating policies may also require that you perform an actual assay prior to accepting the reader for routine use. If this is the case, you should not use the data obtained from the first assay run on the reader until you have confirmed that the package insert criteria have been met.
- The OQ procedure should be performed initially (before first use) and then routinely; the recommended interval is annually. It should also be performed after any major repair or upgrade to the hardware or software.
- Although out-of-tolerance failures will be detected by the OQ tests, results should be compared with those from the routine Performance Qualification tests and previous OQ tests to monitor for trends.
- The successful completion of the OQ procedure, in combination with results that are comparable to previous PQ and OQ tests, confirms that the equipment is operating according to specification initially and over time.

Performance Qualification confirms that the reader consistently meets the requirements of the tests performed at your laboratory.

- The recommended PQ procedure consists of performing the System Test, Absorbance Plate Test, a series of Liquid Tests, and, if the external dispense module is used, the Dispense Accuracy and Precision Tests.
- Your facility's operating policies may also require that you routinely perform an actual assay, to confirm that the reader will consistently give adequate results for the assays to be run on it.
- These tests should be performed routinely; the recommended interval is monthly or quarterly, depending on the test. This frequency may be adjusted depending on the trends observed over time.
- The successful completion of the PQ procedure confirms that the equipment is performing consistently under normal operating conditions.

Recommended Qualification Schedule

The schedule below defines the factory-recommended intervals for qualifying a Synergy 2 used two to five days a week. The actual frequency, however, may be adjusted depending on your usage of the instrument and its various modules. This schedule assumes the reader is properly maintained as outlined in **Chapter 6, Preventive Maintenance**.

Tasks/ Tests	IQ	OQ	PQ	
	Initially	Initially/ Annually	Monthly	Quarterly
All models:				
Installation, setup, and configuration of the reader, dispense module (if equipped), the host computer, and Gen5 software	✓			
System Test	✓	✓	✓	
Models with the Absorbance module:				
Absorbance Plate Test		✓	✓	
Absorbance Liquid Test 1 or 2*		✓		✓
Absorbance Liquid Test 3 (optional)**		✓		✓
Models with the Fluorescence module(s):				
Corners, Sensitivity, Linearity (FI) Tests		✓	✓	
Fluorescence Polarization (FP) Tests***		✓		✓
Time-Resolved Fluorescence (TRF) Test***		✓		✓
Models with the Luminescence module:				
Luminescence Test		✓	✓	
Models with the Dispense module:				
Injection System Test	✓			
Dispense Accuracy and Precision Test		✓		✓

* Regarding Absorbance Liquid Tests 1 and 2:

- If you have an Absorbance Test Plate, run Liquid Test 1.
- If you do not have an Absorbance Test Plate, run Liquid Test 2.

** Liquid Test 3 is optional; it is provided for sites requiring verification at wavelengths lower than those attainable with the Absorbance Test Plate.

*** If applicable to your reader model.

System Test

Each time the Synergy 2 is turned on, it automatically performs a series of tests on the reader's motors, lamps, the PMT, and various sub-systems. The duration of this "System Test" depends on the reader model, and can a few minutes to complete. If all tests pass, the microplate carrier will eject and the LED on the power switch will remain on and constant. The reader is then ready for use.

If any test results do not meet the internally-coded Failure Mode Effects Analysis (FMEA) criteria established by BioTek, the reader will beep repeatedly and the LED on the power switch will flash repeatedly. If this occurs, press the Carrier Eject button to stop the beeping. If necessary, initiate another System Test using Gen5 to try to retrieve an error code from the reader. Refer to **Appendix B, Error Codes** for information on error codes and for troubleshooting tips.

To run the System Test:

1. Turn on the reader and launch Gen5.
2. If applicable, set Gen5's Absorbance wavelength table to the six wavelengths you most frequently use.
3. If your assays use incubation, we recommend enabling Temperature Control and allowing the incubator to reach its set point before running the System Test. To access this feature, select System > Reader Control and click the Pre-Heating tab.
4. Select System > Diagnostics > Run System Test.

❖ If the test fails during execution, a message box will appear in the software. Close the box; the test report will contain the error code that was generated by the failure.

5. When the test is complete, a dialog will appear, requesting additional information. Enter your User name and other information (if desired) and then click OK.
6. The test report will appear. Scroll down toward the bottom of the report; it will show either "SYSTEM TEST PASS" or "SYSTEM TEST FAIL *** ERROR (error code) DETECTED."
7. Print the report if desired.
 - A sample test report is shown on the next few pages.
 - Gen5 stores the results in a database, so the results can be retrieved at any time. We recommend that you print and save the reports to document that the test was performed.
8. If the test failed, look up the error code in **Appendix B, Error Codes** to determine its cause. If the cause is something you can fix, turn off the reader, fix the problem, and then turn the reader back on and retry the test. If the test continues to fail, or if the cause is not something you can fix, contact BioTek's Technical Assistance Center.

❖ A sample test report for a Synergy 2 with all modules installed is shown on the next few pages. Your instrument's test report may be different. If you have any questions about the report's contents or the test results, please print the report and then contact BioTek's Technical Assistance Center.

```

                                Gen5 System Test Report

Reader:                          Synergy 2 (Serial Number: 200351)
Basecode:                        P/N 7130202 (v1.02)
Date and Time:                   6/22/2009 3:28:35 PM
User:                            BioTek User
Company:
Comments:

Test Results

Operator ID: _____

Notes: _____

                                SYSTEM SELF TEST

7130202 Version 1.02             200351             0111 1111 0000 0000

Bias current offset              -2.2 counts        PASS
Offset voltage                   1501 counts        PASS
750V measurement                 24.3 counts        PASS
750V noise                        15 counts
500V measurement                 6.4 counts
500V noise                        1 counts
Reference bias                   0.7 counts
Reference offset                 10982 counts
Reference noise                   0.2 counts

Excitation Wheel
  Filter 1:      360/40
    Gain:        1.00   1.00   1.00   1.00
    Air:         15503  17693  18034  18706
    Dark:        10982  10982  10982  10982
    Delta:       4521   6711   7052   7724
  Filter 2:      485/20
    Gain:        1.00   1.00   1.00   1.00
    Air:         15697  17195  17672  18043
    Dark:        10982  10983  10982  10983
    Delta:       4715   6212   6690   7060
  Filter 3:      540/25
    Gain:        1.00   1.00   1.00   1.00
    Air:         15226  16596  16866  17135
    Dark:        10982  10982  10983  10982
    Delta:       4244   5614   5883   6153
  Filter 4:      PLUG

Emission Wheel
  Filter 1:      460/40
  Filter 2:      528/20

```

Filter 3: 620/40
Filter 4: OPEN

Absorbance

Wavelength 1:	260	Gain:	1.41	Resets:	8
Channel:	Ref	Meas			
Air:	13096	39826			
Dark:	9949	9947			
Delta:	3147	29879			
Wavelength 2:	280	Gain:	1.87	Resets:	4
Channel:	Ref	Meas			
Air:	12950	39368			
Dark:	9958	9954			
Delta:	2992	29414			
Wavelength 3:	405	Gain:	2.82	Resets:	8
Channel:	Ref	Meas			
Air:	12602	39343			
Dark:	9965	9960			
Delta:	2637	29383			
Wavelength 4:	450	Gain:	1.66	Resets:	4
Channel:	Ref	Meas			
Air:	12537	39774			
Dark:	9956	9952			
Delta:	2581	29822			
Wavelength 5:	490	Gain:	2.07	Resets:	8
Channel:	Ref	Meas			
Air:	12487	39975			
Dark:	9957	9953			
Delta:	2530	30022			
Wavelength 6:	630	Gain:	2.51	Resets:	2
Channel:	Ref	Meas			
Air:	12373	39621			
Dark:	9978	9968			
Delta:	2395	29653			

Noise Test

Channel:	Ref	Meas
Noise Max:	10046	10028
Noise Min:	10045	10027
Delta:	1	1

Voltage Reference:	Min	Low	High	Max
Lamp:	3375			
Motor:	3723			
Absorbance Flash:	1314	1596	1982	2264
Fluorescence Flash:	664	834	878	915

INCUBATOR SELF TEST

Temperature Setpoint: 37.0 Current Average: 37.2 A/D Test: PASS

Zone 1:	37.3	Min: 37.2	Max: 37.4	Range: PASS	Thermistor: PASS
Zone 2:	37.1	Min: 37.0	Max: 37.2	Range: PASS	Thermistor: PASS
Zone 3:	37.2	Min: 37.1	Max: 37.3	Range: PASS	Thermistor: PASS
Zone 4:	37.3	Min: 37.2	Max: 37.4	Range: PASS	Thermistor: PASS

AUTOCAL ANALYSIS

PROBE: BOTTOM

Upper Left Corner:	x=	9708	y=	4536
Lower Left Corner:	x=	9696	y=	10068
Lower Right Corner:	x=	1016	y=	10072

```

Upper Right Corner: x= 1024 y= 4540
Delta 1: 9708 - 9696= +12
Delta 2: 1024 - 1016= +8
Delta 3: 4540 - 4536= +4
Delta 4: 10072 -10068= +4

PROBE:                TOP

Upper Left Corner:  x= 10608 y= 192
Lower Left Corner:  x= 10596 y= 5724
Lower Right Corner: x= 1916 y= 5724
Upper Right Corner: x= 1920 y= 196
Delta 1: 10608 -10596= +12
Delta 2: 1920 - 1916= +4
Delta 3: 196 - 192= +4
Delta 4: 5724 - 5724= +0

PROBE:                LUMIN

Upper Left Corner:  x= 9696 y= 2988
Lower Left Corner:  x= 9692 y= 8516
Lower Right Corner: x= 1008 y= 8516
Upper Right Corner: x= 1012 y= 2984
Delta 1: 9696 - 9692= +4
Delta 2: 1012 - 1008= +4
Delta 3: 2984 - 2988= -4
Delta 4: 8516 - 8516= +0

PROBE:                ABSORB

Upper Left Corner:  x= 11252 y= 4536
Lower Left Corner:  x= 11240 y=10064
Lower Right Corner: x= 2556 y=10068
Upper Right Corner: x= 2564 y= 4544
Delta 1: 11252 -11240= +12
Delta 2: 2564 - 2556= +8
Delta 3: 4544 - 4536= +8
Delta 4: 10068 -10064= +4

Monochromator:      A=+0.000000 B=-0.001461 C=-0.147723

Probe Height:      33.93 mm
Plate Sensor:      180

Probe Changer:     572

Mirror:            3864

Lamp Reflector:    1024

Aperture:          2356

Middle Sensor:     y= 11964
Tested:            11972
Delta:             +8

Back Sensor:       x= 11572 y=10688
Tested:            11568 10688
Delta:             -4 +0

SYSTEM TEST PASS
0000

```

```

Dispenser 1: 005.1,010.0,020.0,040.0,080.0,200.1
Dispenser 2: 005.0,010.0,020.0,040.0,080.0,200.2

Mirror 1: 50% Mirror, 0200, 0850, 0200, 0850
Mirror 2: Dichroic , 0320, 0400, 0420, 0800
Mirror 3: Dichroic , 0440, 0500, 0510, 0780
Polarizers present.

```

Reviewed/Approved By: _____ Date: _____

Figure 37: Sample output for the System Test

Absorbance Plate Test

Description

This test uses BioTek's Absorbance Test Plate (PN 7260522) to confirm mechanical alignment; optical density accuracy, linearity, and repeatability; and wavelength accuracy. The Absorbance Plate Test compares the reader's optical density and wavelength measurements to NIST-traceable values.

- **Mechanical Alignment:** The Test Plate has precisely machined holes to confirm the mechanical alignment of the reader. The amount of light that shines through these holes is an indication of whether the reader is properly aligned with the absorbance optical path. A reading of more than 0.015 OD for any of the designated alignment holes indicates that the light is being "clipped" and the reader may be out of alignment.
- **Accuracy/Linearity:** The Test Plate contains neutral-density glass filters of known OD values at several wavelengths. Actual measurements are compared against the expected values provided in the Test Plate's Standards Certificate. Since there are several filters with differing OD values, the accuracy across a range of ODs can be established. Once it is proven that the reader is accurate at these OD values, the reader is also considered to be linear.
- **Repeatability:** This test ensures the instrument meets its repeatability specification by reading each neutral-density filter on the Test Plate twice with the filter in the same location.
- **Wavelength Accuracy:** The Test Plate contains a glass filter in position C6; it is used to check the wavelength accuracy of the absorbance monochromator. The filter is scanned across a specified wavelength range in 1-nm increments. The wavelength of maximum absorbance is compared to the expected peak wavelength supplied on the Test Plate's certificate.

❖ An alternate method for determining accuracy, linearity, and repeatability is Absorbance Liquid Test 2, described on page 95.

Test Plate Certificates

To run this test on the Synergy 2, you'll need BioTek's 7-Filter Absorbance Test Plate (PN 7260522), with its accompanying certificates.

- The Standards Certificate contains standard OD values for the filters at several different wavelengths (see the sample below).
- The Peak Wavelength Certificate contains one or more "Peak Wavelength" values for the glass filter in position C6 on the plate. Each value has a valid test range associated with it. For example, a Peak Wavelength value may be 586 nm with a test range of 580 to 590 nm (or tolerance values of -6/+4).

This test plate can be used for testing the reproducibility, linearity, and alignment of your BioTek autoreader. The following calibration data has been recorded by a N.I.S.T. traceable spectrophotometer.								
WAVELENGTH (nm)								
Well	405nm	450nm	490nm	550nm	620nm	630nm	690nm	750nm
C1	0.147	0.140	0.135	0.130	0.136	0.136	0.127	0.134
E2	0.618	0.575	0.574	0.588	0.576	0.568	0.485	0.434
G3	1.133	1.052	SAMPLE			1.040	0.881	0.783
H6	1.701	1.578				1.560	1.323	1.179
F5	2.279	2.024	1.976	1.956	1.893	1.865	1.537	1.272
D4	2.945	2.604	2.545	2.513	2.437	2.400	1.972	1.632
Set # 2453					Serial # 161259			

Figure 38: Sample Standards Certificate with OD/Wavelength combinations for each of six locations in the Absorbance Test Plate

Before the Absorbance Plate Test can be performed, the standard OD values and the peak wavelength value(s) must be entered into Gen5. You'll enter and save these values once initially, and then update them each time the test plate is recertified by BioTek (typically annually).

Define Absorbance Test Plate Parameters

❖ *Gen5 version 1.07 and earlier users only:* The Gen5 Reader Diagnostics Utility must be installed to run the Absorbance Plate Test.

1. Obtain the certificates that came with the Test Plate.
2. Start Gen5 and select System > Diagnostics > Test Plates > Add/ Modify Plates.
3. Click Add. The Absorbance Test Plate dialog will appear.
4. Select the appropriate Plate Type and enter the plate's Serial Number.

5. Enter the Last Certification and Next Certification dates from the calibration sticker on the Test Plate.
6. If the wavelength values in the top row of the grid are appropriate for your tests, enter the OD values from the Standards Certificate into the grid. Make sure you enter the correct value for each well/wavelength combination.
 - If you need to change the wavelength values, click Wavelength List. Click the Gen5 Help button for assistance.
7. Select the number of Peak Wavelength tests to run (1 to 4), based on the number of peak wavelength values provided on the Peak Wavelength Certificate.
8. Enter the Expected Peak value(s) from the Peak Wavelength Certificate. (If multiple values are given for a wavelength, use those in the 2.4 nm Spectral Bandpass table.) For each value, define the expected Test Range by selecting the minus/plus tolerance values. The range must span at least 8 nm.

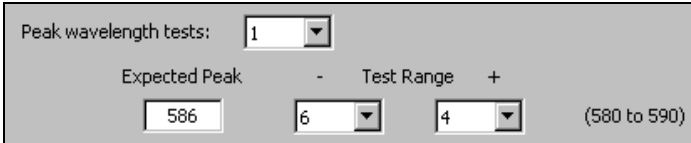

Peak wavelength tests: 1

Expected Peak - Test Range +

586 6 4 (580 to 590)

❖ For certificates that have only one peak wavelength and a fixed wavelength range of 580 to 590 nm, enter the Expected Peak wavelength value and adjust the Test Range values so the range displayed in parentheses is 580 to 590 (as demonstrated above).

9. Review all of the values you entered, and then click OK to save the data.

The information you just entered will be available in Gen5 each time the Absorbance Plate Test is performed. It may need to be modified after the annual recertification of your test plate.

Run the Absorbance Plate Test

1. In Gen5, select System > Diagnostics > Test Plates > Run.
2. If prompted, select the desired Test Plate and click OK.
3. When the Absorbance Test Plate Options dialog appears, select Perform Peak Wavelength Test if it is not already selected.
4. Highlight the wavelength(s) to be included in this test. You only need to select those wavelengths most appropriate for your use of the reader.
5. (Optional) Enter any Comments.
6. Click Start Test.
7. Place the Test Plate in the microplate carrier so that well A1 is in the left-rear corner of the carrier.
8. Click OK to run the test.

9. When the test is completed, the results report appears. Scroll through the report; every result should show "PASS". See page 91 for information on results and troubleshooting tips in the event of failures.
 - A sample test report is shown below.
 - Gen5 stores the results in a database; they can be retrieved any time. We recommend you print and save the report to document that the test was performed.

Sample Report

Absorbance Test Plate Results						
Reader:	Synergy 2 (Serial Number: 200363)					
Basecode:	P/N 7130202 (v1.02)					
Date and Time:	11/16/2009 10:01:05 AM					
Absorbance Plate:	7 Filter Test Plate (P/N 7260522) - S/N 179269					
Last Plate Certification:	September 2009					
Next Plate Certification Due:	September 2010					
User:	BioTek User					
Comments:	Test run during initial OQ					
Peak Absorbance Results						
Well	C6					
Reference	586					
Tolerance	3					
Read	586					
Result	PASS					
Alignment Results						
Wells	A1	A12	H1	H12		
Read	0.002	0.002	0.003	0.002		
Tolerance	0.015	0.015	0.015	0.015		
Result	PASS	PASS	PASS	PASS		
Wavelength = 405 nm						
Accuracy Results						
Wells	C1	E2	G3	H6	F5	D4
Reference	0.140	0.632	1.200	1.744	2.076	2.679
Min Limit	0.117	0.599	1.156	1.689	1.973	2.552
Max Limit	0.163	0.665	1.244	1.799	2.179	2.806
Read 1	0.144	0.633	1.201	1.744	2.074	2.691
Result	PASS	PASS	PASS	PASS	PASS	PASS
Repeatability Results						
Wells	C1	E2	G3	H6	F5	D4
Read 1	0.144	0.633	1.201	1.744	2.074	2.691
Min Limit	0.138	0.622	1.184	1.722	2.007	2.605
Max Limit	0.150	0.644	1.218	1.766	2.141	2.777
Read 2	0.144	0.633	1.201	1.745	2.074	2.688
Result	PASS	PASS	PASS	PASS	PASS	PASS

Figure 39: Sample Absorbance Plate Test Report

Results & Troubleshooting Tips

The Absorbance Test Plate Report contains results for the following:

- **Peak Absorbance:** When the test is performed, the C6 filter is scanned at the test range(s) defined by the user in the Absorbance Test Plate dialog. To verify wavelength accuracy, the wavelength of the maximum absorbance is compared with the peak wavelength value entered in the software, which comes from the Peak Wavelength Certificate supplied with the Test Plate. The accuracy of the wavelength should be ± 3 nm (± 2 nm instrument, ± 1 nm filter allowance). If the reader fails this test:
 - Make sure the information entered into Gen5 matches the information on the Test Plate's Peak Wavelength Certificate.
 - Verify that the Test Plate has a filter in location C6. (Test Plates with part number 9000547 do not have this filter.)
 - Check the C6 filter to make sure it is clean. If needed, clean it with lens paper. **Do not remove the filter from the Test Plate, and do not use alcohol or other cleaning agents.**
 - Make sure the Test Plate is within its calibration certification period. If it is out of date, contact BioTek to schedule a recertification.
 - Check the microplate carrier to ensure it is clear of debris.
- **Alignment:** This portion of the test measures the alignment of the microplate carrier with the optical path. A reading greater than 0.015 OD represents an out-of-alignment condition. If the reader fails this test:
 - Ensure that the Test Plate is correctly seated in the microplate carrier.
 - Check the four alignment holes (A1, A12, H1, H12) to ensure they are clear of debris.
 - Check the microplate carrier to ensure it is clear of debris.
- **Accuracy:** Accuracy is a measure of the optical density of Test Plate wells C1, D4, E2, F5, G3, and H6 as compared with known standard values contained in the test plate's Standards Certificate. If the reader fails this test:
 - Verify that the filter calibration values entered in Gen5 are the same as those on the Test Plate's Standards Certificate.
 - Check the neutral-density filters on the Test Plate to ensure they are clean. If needed, clean them with lens paper. **Do not remove the filters from the test plate, and do not use alcohol or other cleaning agents.**
 - Make sure the Test Plate is within its calibration certification period. If it is out of date, contact BioTek to schedule a recertification.

Linearity of the optical density readings is confirmed by default if the optical density readings are accurate. To further verify this, you can perform a

regression analysis on the Test Plate OD values in a spreadsheet program such as Microsoft Excel. An R Square value of at least 0.990 is expected.

- **Repeatability:** Repeatability is a measure of the instrument's ability to read the same well with minimum variation between two reads with the well in the same location. If the reader fails this test:
 - Check the filters on the Test Plate to ensure there is no debris that may have shifted between readings and caused changes.
 - Check the microplate carrier to ensure it is clear of debris.

Absorbance Liquid Tests

Conducting Liquid Tests confirms the reader's ability to perform to specification with liquid samples. Liquid testing differs from testing with the Absorbance Test Plate in that liquid in the wells has a meniscus, whereas the Test Plate's neutral density glass filters do not. The optics characteristics may differ in these two cases, thus alerting the operator to different types of problems.

- **Liquid Test 1** confirms repeatability and alignment of the reader when a solution is used in the microplate. If these tests pass, then the lens placement and optical system cleanliness are proven.
- The recommended method for testing the instrument's alignment, repeatability, and accuracy is to use the Absorbance Test Plate (see page 87). If the Test Plate is not available, however, **Liquid Test 2** can be used for these tests.
- **Liquid Test 3** verifies operation of the reader at 340 nm, and is provided for sites requiring proof of linearity at wavelengths lower than those attainable with the Absorbance Test Plate. This test is optional because the reader has good "front end" linearity throughout its wavelength range.

Absorbance Liquid Test 1

Materials

❖ Manufacturer part numbers are subject to change.

- New 96-well, clear, flat-bottom microplate (Corning Costar #3590 recommended)
- Stock Solution A or B, which may be formulated by diluting a dye solution available from BioTek (A) or from the ingredients listed below (B).

Solution A

- BioTek QC Check Solution No. 1 (PN 7120779, 25 mL; PN 7120782, 125 mL)
 - Deionized water
 - 5-mL Class A volumetric pipette
 - 100-mL volumetric flask
1. Pipette a 5-mL aliquot of BioTek QC Check Solution No. 1 into a 100-mL volumetric flask.
 2. Add 95 mL of DI water; cap and shake well. The solution should measure approximately 2.000 OD when using 200 μ L in a flat-bottom microwell.

Solution B

- Deionized water
 - FD&C Yellow No. 5 dye powder (typically 90% pure)
 - Tween 20 (polyoxyethylene (20) sorbitan monolaurate) or BioTek wetting agent (PN 7773002) (a 10% Tween solution)
 - Precision balance with capacity of 100 g minimum and readability of 0.001 g
 - Weigh boat
 - 1-liter volumetric flask
1. Weigh out 0.092 g of FD&C Yellow No. 5 dye powder into a weigh boat.
 2. Rinse the contents into a 1-liter volumetric flask.
 3. Add 0.5 mL of Tween 20, or 5 mL of BioTek's wetting agent.
 4. Fill to 1 liter with DI water; cap and shake well. The solution should measure approximately 2.000 OD when using 200 μ L in a flat-bottom microwell.

Prepare the Plate

❖ Use a new microplate. Fingerprints or scratches may cause variations in readings.

1. Using freshly prepared stock solution (Solution A or B), prepare a 1:2 dilution using deionized water (one part stock, one part deionized water; the resulting solution is a 1:2 dilution).
2. Pipette 200 μL of the concentrated solution (A or B) into the first column of wells in the microplate.
3. Pipette 200 μL of the diluted solution into the second column of wells.

❖ After pipetting the diluted test solution into the microplate and before reading the plate, we strongly recommend shaking the plate at Variable speed for four minutes. This will allow any air bubbles in the solution to settle and the meniscus to stabilize. Alternatively, wait 20 minutes after pipetting the test solution before reading the plate.

Read the Plate

1. Using Gen5, read the microplate **five times** at 405 nm using the Normal read mode, single wavelength, no blanking. Save the data after each read (“Normal” plate position).
2. Without delay, **rotate** the microplate 180 degrees so that well A1 is in the “H12” position. Read the plate five more times, saving the data after each read (“Turnaround” plate position).
3. Print out the ten sets of raw data, or export them to an Excel spreadsheet.

Analyze the Results

1. The plate is read five times in the “Normal” position at 405 nm. Calculate the Mean OD and Standard Deviation of those five reads for each well in columns 1 and 2.
2. For each well in columns 1 and 2, calculate the Allowed Deviation using the repeatability specification for a 96-well plate: $\pm 1\% \pm 0.005 \text{ OD}$ (Mean $\times 0.010 + 0.005$). For each well, its standard deviation should be less than its allowed deviation.

Example: Five readings in well A1 of 0.802, 0.802, 0.799, 0.798, and 0.801 result in a mean of 0.8004 and a standard deviation of 0.0018. The mean multiplied by 1.0% (0.8004×0.010) equals 0.008, and when added to 0.005 equals 0.013; this is the allowed deviation for well A1. Since the standard deviation for well A1 is less than 0.013, the well meets the test criteria.

3. The plate is read five times in the “Turnaround” position at 405 nm. Calculate the Mean OD of those five reads for each well in columns 11 and 12.

4. Perform a mathematical comparison of the Mean values for each microwell in its Normal and Turnaround positions (that is, compare A1 to H12, A2 to H11, B1 to G12, ... H2 to A11). To pass the test, the differences in the compared mean values must be within the accuracy specification for a 96-well microplate: $\pm 1.0\% \pm 0.010$ OD from 0.000 to 2.000 OD.

Example: If the mean value for well A1 in the Normal position is 1.902 with a specified accuracy of $\pm 1.0\% \pm 0.010$ OD, then the expected range for the mean of the well in its Turnaround (H12) position is 1.873 to 1.931 OD. $1.902 \times 0.010 + 0.010 = 0.029$; $1.902 - 0.029 = 1.873$; $1.902 + 0.029 = 1.931$.

Absorbance Liquid Test 2

Materials

- A new 96-well, clear, flat-bottom microplate (Corning Costar #3590 is recommended)
- Ten test tubes, numbered consecutively, set up in a rack
- Calibrated hand pipette (Class A volumetric pipette recommended)
- Solution A or B (see the instructions on page 93)
- A 0.05% solution of deionized water and Tween 20

Prepare the Dilutions

Create a percentage dilution series, beginning with 100% of the original concentrated stock solution (A or B) in the first tube, 90% of the original solution in the second tube, 80% in the third tube, all the way to 10% in the tenth tube. Dilute using the 0.05% solution of deionized water and Tween 20. This solution can also be made by diluting the BioTek wetting agent 200:1.

Tube Number:	1	2	3	4	5	6	7	8	9	10
Volume of Original Concentrated Solution (mL)	20	18	16	14	12	10	8	6	4	2
Volume of 0.05% Tween Solution (mL)	0	2	4	6	8	10	12	14	16	18
Absorbance expected if original solution is 2.0 at 200 μ L	2.0	1.8	1.6	1.4	1.2	1.0	0.8	0.6	0.4	0.2

❖ The choice of dilutions and the absorbance of the original solution can be varied. Use this table as a model for calculating the expected absorbances of a series of dilutions, given a different absorbance of the original solution.

Prepare the Plate

- Pipette 200 μ L of the concentrated solution from Tube 1 into each well of the first column, A1 to H1, of a new flat-bottom microplate.
- Pipette 200 μ L from each of the remaining tubes into the wells of the corresponding column of the microplate (Tube 2 into wells A2 to H2, Tube 3 into wells A3 to H3, and so on).

Linearity & Repeatability Tests

1. Using Gen5, read the microplate prepared above **five times** using Normal mode, dual wavelength at 450/630 nm. Save the data after each read.

❖ Do not discard the plate; you will use it for the Alignment test.

2. Print out the five sets of Delta OD data, or export them to an Excel spreadsheet.
3. Calculate the results for Linearity:
 - Calculate the mean absorbance for each well, and average the means for each concentration.
 - Perform a regression analysis on the data to determine if there is adequate linearity. Since it is somewhat difficult to achieve high pipetting accuracy when conducting linear dilutions, an R Square value of at least 0.99 is considered adequate.
4. Calculate the results for Repeatability:
 - Calculate the mean and standard deviation for the five readings taken in Step 1 at each concentration. Only one row of data needs to be analyzed.
 - For each mean below 2.000 OD, calculate the allowed deviation using the repeatability specification for a 96-well plate of $\pm 1.0\% \pm 0.005$ OD. (If above 2.000 OD, apply the $\pm 3.0\% \pm 0.005$ specification.)
 - The standard deviation for each set of readings should be less than the allowed deviation.

Example: Absorbance readings of 1.950, 1.948, 1.955, 1.952, and 1.950 result in a mean of 1.951, and a standard deviation of 0.0026. The mean (1.951) multiplied by 1.0% (1.951×0.010) = 0.0195, which, when added to the 0.005 ($0.0195 + 0.005$) = 0.0245 OD, which is the allowable deviation. Since the standard deviation is less than this value, the reader meets the test criteria.

Alignment Test

1. Using the plate prepared for the Linearity Test, conduct a Turnaround test by reading the plate **five times** with the A1 well in the H12 position. Save the data after each read.

2. Calculate the means of the wells A1 and H1 in the Normal plate position (data from Linearity Test) and in the Turnaround position (from Step 1).
3. Compare the mean reading for well A1 to its mean reading when in the H12 position. Next, compare the mean values for the H1 well to the same well in the A12 position. The difference in the values for any two corresponding wells should be within the accuracy specification for a 96-well plate, $\pm 1.0\% \pm 0.010$ OD from 0.000 to 2.000 OD.

Example: If the mean of well A1 in the normal position is 1.902, where the specified accuracy is $\pm 1.0\% \pm 0.010$ OD, then the expected range for the mean of the same well in the H12 position is 1.873 to 1.931 OD. ($1.902 \times 1.0\% = 0.019 + 0.010 = 0.029$, which is added to and subtracted from 1.902 for the range.)

If the four corner wells are within the accuracy range, the reader is in alignment.

Absorbance Liquid Test 3 (Optional)

Materials

❖ Manufacturer part numbers are subject to change.

- New 96-well, clear, flat-bottom microplate (Corning Costar #3590 recommended)
- Calibrated hand pipette(s)
- Beakers and graduated cylinder
- Precision balance with readability to 0.01 g
- Buffer solution described below

Buffer Solution

- Deionized water
 - Phosphate-Buffered Saline (PBS), pH 7.2-7.6, Sigma tablets, #P4417 (or equivalent)
 - β -NADH Powder (β -Nicotinamide Adenine Dinucleotide, Reduced Form) Sigma bulk catalog number N 8129, or preweighed 10-mg vials, Sigma number N6785-10VL (or BioTek PN 98233). Store the powder according to the guidelines on its packaging.
1. Prepare a PBS solution from the Sigma tablets.
 2. In a beaker, mix 50 mL of the PBS solution with 10 mg of the β -NADH powder and mix thoroughly. This is the **100% Test Solution**.

3. (Optional) Read a 150- μ L sample of the solution at 340 nm; it should be within 0.700 to 1.000 OD. If low, adjust up by adding more powder. Do not adjust if slightly high.

Prepare the Plate

1. Prepare the **75% Test Solution** by mixing 15 mL of the 100% Test Solution with 5 mL of the PBS Solution.
2. Prepare the **50% Test Solution** by mixing 10 mL of the 100% Test Solution with 10 mL of the PBS Solution.
3. Carefully pipette the three solutions into a new 96-well microplate:
 - 150 μ L of the 100% Test Solution into all wells of columns 1 and 2
 - 150 μ L of the 75% Test Solution into all wells of columns 3 and 4
 - 150 μ L of the 50% Test Solution into all wells of column 5 and 6

Read the Plate

1. Using Gen5, read the microplate **five times** using Normal mode, single wavelength at 340 nm, no blanking. Save the data after each read.
2. Print out the five sets of raw data, or export them to an Excel spreadsheet.

Analyze the Results

1. For each well, calculate the Mean OD and Standard Deviation of the five readings.
2. For each mean calculated in step 1, calculate the allowed deviation using the repeatability specification for a 96-well plate: $\pm 1\% \pm 0.005$ OD (Mean $\times 0.010 + 0.005$). For each well, its standard deviation should be less than its allowed deviation.

Example: Five readings in well A1 of 0.802, 0.802, 0.799, 0.798, and 0.801 result in a mean of 0.8004 and a standard deviation of 0.0018. The mean multiplied by 1.0% (0.8004 \times 0.010) equals 0.008, and when added to 0.005 equals 0.013; this is the allowed deviation for well A1. Since the standard deviation for well A1 is less than 0.013, the well meets the test criteria.

3. Calculate the results for Linearity:
 - For each of the three Test Solutions, calculate the average Mean OD for the wells containing that solution (mean of wells A1-H2, A3-H4, and A5-H6).
 - Perform a regression analysis on the data to determine if there is adequate linearity. The three average Mean OD values are the “Y” values. The solution concentrations are the “X” values (1.00, 0.75, 0.50). Since it is somewhat difficult to achieve high pipetting accuracy when conducting linear dilutions, an R Square value of at least 0.99 is considered adequate.

Fluorescence Liquid Tests

For Synergy 2 models with fluorescence capability, BioTek has developed a series of module-specific liquid tests for verifying performance.

- **Corners test:** Verifies that the plate carrier is properly aligned in relation to the fluorescence probes.
- **Sensitivity test:** Verifies the fluorescence reading capability of the reader. The ability to detect specific compounds at low concentrations ensures that the filters, optical path, and PMT are all in working order. This test verifies that the difference between the mean of wells with known lower limits of concentration of the substance under investigation is statistically distinguishable from the mean of wells with pure diluent.
- **Linearity test:** Verifies that the system is linear; that is, signal changes proportionally with changes in concentration. Proving that the system is linear allows the Sensitivity Test to be run on two points instead of using serial dilutions.
- **FP test:** Verifies the ability of the instrument to measure polarization of the solution properly. It verifies the polarizers are installed in the proper orientation, and the mechanism is in proper order.
- **TRF test:** Verifies the performance of the xenon flash bulb and that the filters, optical path, and PMT are all in working order.



The tests presented in this section require specific microplates, solutions, filters, and mirrors. Your laboratory may require a deviation from some of these tests. For example, you may wish to use a different fluorescing solution, dichroic mirror, and/or microplate.

If deviation from the tests as presented in this section is required, the following steps should be taken the first time each test is run (e.g., during the **Initial OQ**):

- 1 Perform the tests exactly as described on the following pages.
- 2 Re-run the tests using your particular solutions, filters, mirrors, microplates, etc. If results are comparable, then the results from these tests will be your baseline for future tests.
- 3 Be sure to document your new test procedure(s), and save all test results.

Required Materials

- ❖ BioTek offers test kits containing the microplates and solutions used in fluorescence liquid test procedures; see page 23.
- ❖ Microplates should be perfectly clean and free of dust or bottom scratches. Use new microplates from sealed packages.

All Tests

- Deionized or distilled water
- Various beakers, graduated cylinders, and pipettes
- 95% ethanol (for cleaning clear-bottom plates)
- Aluminum foil
- (Optional, but recommended) 0.45-micron filter
- (Optional) Black polyethylene bag(s) to temporarily store plate(s)
- The “Fluorescence Liquid Tests” Gen5 protocols described starting on page 111

Corners/ Sensitivity/ Linearity (FI) Tests

- ❖ Methylumbelliferone can be used as an alternative or supplemental method for performing these tests for the top probe. See page 114.

- Bottom optics: A clean Hellma® Quartz 96-well titration plate (Mfr. #730.009.QG), or equivalent, such as the 96-well glass-bottom Greiner SensoPlate™ (Mfr. #655892).
- Top optics: A new, clean, 96-well solid black microplate, such as Corning® Costar Mfr. #3915. The Greiner SensoPlate mentioned above can also be used.
- Buffer:
 - NIST-traceable Sodium Borate Reference Standard (pH 9.18), (e.g., Fisher-Scientific 1 L Sodium Borate Mfr. #159532, or equivalent), or
 - Phosphate-Buffered Saline (PBS), pH 7.2-7.6 (Sigma® tablets, Mfr. #P4417, or equivalent) and pH meter or pH indicator strips with pH range 4 to 10
- Sodium Fluorescein Powder (1-mg vial, BioTek PN 98155)
- Excitation filter 485/20 nm and Emission filter 528/20 nm installed
- 510 nm dichroic mirror installed

Fluorescence Polarization (FP) Test

❖ The FP Test can be performed in conjunction with the top Corners/Sensitivity/Linearity Tests, in the same microplate.

- A new, clean, 96-well solid black microplate, such as Corning® Costar Mfr. #3915. A Greiner SensoPlate can also be used.
- The recommended test solutions are available from Invitrogen™ Corporation, in their “FP One-Step Reference Kit,” (PN P3088) and from BioTek (see page 23). The Invitrogen kit includes:
 - Green Polarization Reference Buffer, 15 mL
 - Green Low Polarization Reference, 4 mL
 - Green High Polarization Reference, 4 mL
 - The kit also includes two red polarization solutions; these are not used
- Excitation filter 485/20 nm and Emission filter 528/20 nm installed
- 510 nm dichroic mirror and polarizers installed

Time-Resolved Fluorescence (TRF) Test

- 15 mL conical-bottom, polypropylene sample tube
- Excitation filter 360/40 nm and Emission filter 620/40 nm installed
- 400 nm dichroic mirror installed
- A new, clean 96-well solid white microplate, such as Corning Costar Mfr. #3912.
- The recommended test solution (FluoSpheres carboxylate-modified microspheres, 0.2 µm europium luminescent, 2 µL) is available from Invitrogen Corporation (PN F20881) and from BioTek (see page 23).

Test Solutions

Determine which tests you need to run for your reader model, and then prepare the necessary solutions. The supplies for each test are listed under “Required Materials” on page 100.

❖ Filter the solutions to remove particulates that could cause erroneous readings. Do not allow dust to settle on the surface of the solution; use microplate covers or seals when not reading the plate.

Corners/ Sensitivity/ Linearity (FI) Tests



If using BioTek's sodium fluorescein powder (PN 98155), be sure to hold the vial upright and open it carefully; the material may be concentrated at the top. If a centrifuge is available, spin down the tube before opening.

When diluting the sodium fluorescein powder in buffer, it takes time for the powder to completely dissolve. Allow the solution to dissolve for 4 to 5 minutes, with intermittent vortexing, before preparing the titration dyes.

Wrap the vial containing the SF stock solution in foil to prevent exposure to light.

Discard any open, unused solutions after seven days.

1. The Sodium Borate solution described on page 100 does not require further preparation; proceed to step 2. If you are using PBS, prepare the solution now:
 - (Optional, but recommended) Using a 0.45-micron filter, filter 200 mL of deionized or distilled water.
 - Follow the manufacturer's instructions on the PBS packaging to create 200 mL, dissolving the necessary amount of PBS into the filtered water.
 - Stir the solution (preferably using a stir table) until the PBS is completely dissolved.
 - Check the pH; it should be between 7.2 and 7.6 at 25°C.
2. Prepare the sodium fluorescein stock solution:
 - Add 2.0 mL of the buffer solution to the 1 mg Sodium Fluorescein (SF) vial. This yields a 1.3288 mM stock solution.
 - Ensure that the dye has completely dissolved and is well mixed.
3. Prepare the dilutions. Label each with "SF" and the concentration:

Mix this SF solution:	with buffer:	to make:	
0.53 mL of 1.3288 mM stock solution	13.47 mL	50.2 μ M	
110 μ L of 50.2 μ M SF	13.89 mL	400 nM	
3.5 mL of 400 nM SF	10.5 mL	100 nM	
0.46 mL of 100 nM SF	13.54 mL	3.3 nM	<i>Corners Test</i>
4.24 mL of 3.3 nM SF	9.76 mL	1 nM	<i>Sensitivity/Linearity Tests</i>

Fluorescence Polarization (FP) Test

The test solutions described on page 101 do not require additional preparation.

Time-Resolved Fluorescence (TRF) Test

- Shake the FluoSphere® container vigorously for 30 seconds prior to pipetting. Alternatively, sonicate or vortex the container.
- Mix 10 µL of FluoSpheres with 10 mL of deionized water, in a 15-mL conical-bottom, polypropylene sample tube. This yields a 20-nM equivalent suspension.
- Shake the vial vigorously for 30 seconds prior to pipetting. Alternatively, sonicate or vortex the container.
- Mix 10 µL of 20-nM suspension with 10 mL of deionized water, in a 15-mL conical-bottom, polypropylene sample tube. This yields a 20-pM equivalent suspension.
- Refrigerate any unused portions of the FluoSpheres. The temperature must be between +2°C to +6°C.

- ❖ The prepared TRF plate can be kept for a maximum of 7 days, if covered and stored in the dark between +2°C to +6°C.
- ❖ Allow the plate to sit at room temperature for approximately 15 minutes prior to use.
- ❖ Shake the plate gently prior to the read.

Procedure

1. If you have not already done so, create the Gen5 protocols as described on page 111.
2. If you have not already done so, prepare the solutions for the tests you plan to perform. See pages 101.

❖ Refer to the pipette maps starting on page 105 for steps 3 through 6.

3. Perform the **FI** tests using the **Bottom** optics:
 - Pipette the solutions for the Corners, Sensitivity, and Linearity Tests into a clean 96-well quartz or glass-bottom microplate.
 - Create an experiment based on the **FI_B.prt** protocol. Read the plate and then save the experiment.
4. Perform the **FI** tests using the **Top** optics:
 - Pipette the solutions for the Corners, Sensitivity, and Linearity Tests into a new 96-well solid black or glass-bottom microplate.
 - Create an experiment based on the **FI_T.prt** protocol. Read the plate and then save the experiment.
5. If you are testing **FP**:
 - Pipette the solutions for the FP test into the same plate as used in step 4.
 - Create an experiment based on the **FP.prt** protocol. Read the plate and then save the experiment.
6. If you are testing **TRF**:
 - Pipette the solutions for the TRF test into a new 96-well solid white plate.
 - Create an experiment based on the **TRF.prt** protocol. Read the plate and then save the experiment.
7. Calculate and evaluate results as described under **Results Analysis**, starting on page 108.

Pipette Maps

❖ Seal the plates with foil or store them in black polyethylene bags until use. When using a clear-bottom plate, if the base is touched, clean the entire base with alcohol (95% ethanol) and then wipe with a lint-free cloth. Before placing a plate in the instrument, blow the bottom of the plate with an aerosol duster.

The Corners, Sensitivity/Linearity, and FP pipette maps are designed so that multiple tests can be run using the same plate. For example:

- Corners, Sensitivity, and Linearity tests for the bottom optics can be performed using the same quartz or glass-bottom plate.
- Corners, Sensitivity, Linearity, and FP tests (top optics) can be performed using the same solid black plate.

Corners Test

❖ You can omit the buffer when using a solid black plate or the Greiner SensoPlate.

- Pipette 200 μ L of the **3.3 nM SF** solution into the “corner” wells.
- Pipette 200 μ L of the buffer in the wells surrounding the SF.

	1	2	3	4	5	6	7	8	9	10	11	12
A	3.3 nM	3.3 nM	3.3 nM	BUF					BUF	3.3 nM	3.3 nM	3.3 nM
B	BUF	BUF	BUF	BUF					BUF	BUF	BUF	BUF
C												
D												
E												
F												
G	BUF	BUF	BUF	BUF					BUF	BUF	BUF	BUF
H	3.3 nM	3.3 nM	3.3 nM	BUF					BUF	3.3 nM	3.3 nM	3.3 nM

Sensitivity and Linearity Tests

Use a multi-channel pipette with four tips installed.

Perform these instructions carefully, and refer to the plate map below.

- Pipette 150 μ L of buffer into columns 2-5 and 10-12.
- Discard the tips.
- Pipette 150 μ L of the 1 nM SF solution into column 1.
- Pipette 150 μ L of the 1 nM SF solution into column 2.
Mix the wells using the pipette. Do not discard the tips.
- Aspirate 150 μ L from column 2 and dispense into column 3.
Mix the wells using the pipette. Do not discard the tips.
- Aspirate 150 μ L from column 3 and dispense into column 4.
Mix the wells using the pipette. Do not discard the tips.
- Aspirate 150 μ L from column 4 and dispense into column 5.
Mix the wells using the pipette. Do not discard the tips.
- Aspirate 150 μ L from column 5. Discard the solution and the tips.

	1	2	3	4	5	6	7	8	9	10	11	12
A												
B												
C	1.0 nM	0.5 nM	0.25 nM	0.125 nM	0.0625 nM					BUF	BUF	BUF
D	1.0 nM	0.5 nM	0.25 nM	0.125 nM	0.0625 nM					BUF	BUF	BUF
E	1.0 nM	0.5 nM	0.25 nM	0.125 nM	0.0625 nM					BUF	BUF	BUF
F	1.0 nM	0.5 nM	0.25 nM	0.125 nM	0.0625 nM					BUF	BUF	BUF
G												
H												

FP Test

- Pipette 200 μ L of the green polarization buffer (BUF) into wells A6-H6.
- Pipette 200 μ L of the green high polarization reference (HPR) into wells A7-B7.
- Pipette 200 μ L of the green low polarization reference (LPR) into wells A8-H8.

	1	2	3	4	5	6	7	8	9	10	11	12
A						BUF	HPR	LPR				
B						BUF	HPR	LPR				
C						BUF		LPR				
D						BUF		LPR				
E						BUF		LPR				
F						BUF		LPR				
G						BUF		LPR				
H						BUF		LPR				

TRF Test

- Pipette 200 μ L of deionized water into wells A6-H6.
- If you have not already done so, shake the vial of 20 pM europium suspension vigorously for 30 seconds prior to pipetting. Alternatively, sonicate or vortex the vial.
- Pipette 200 μ L of the 20 pM europium suspension (Eu) into wells A8-B8.

	1	2	3	4	5	6	7	8	9	10	11	12
A						DI		Eu				
B						DI		Eu				
C						DI						
D						DI						
E						DI						
F						DI						
G						DI						
H						DI						

Results Analysis

Corners Test

1. Calculate the Mean of the wells containing the 3.3 nM SF test solution (A1-A3, A10-A12, H1-H3, H10-H12).
2. Calculate the Standard Deviation for the same 12 wells.
3. Calculate the % CV: (Standard Deviation/Mean) * 100
The % CV must be < 3.0 to pass.

Sensitivity Test

1. Calculate the Mean and Standard Deviation for the buffer wells (C10-F12).
2. Calculate the Mean for the 1000 pM (1 nM) SF solution wells (C1-F1).
3. Calculate the Detection Limit, in pM:
 $1000 / ((\text{Mean SF} - \text{Mean Buffer}) / (3 * \text{Standard Deviation Buffer}))$

Optic Probe	To pass, the Detection Limit must be:
Bottom 5 mm	< 26 pM (10 pg/mL)
Bottom 3 mm	< 53 pM (20 pg/mL)
Bottom 1.5 mm	< 106 pM (40 pg/mL)
Top, with 510 nm dichroic mirror	< 5 pM (2 pg/mL)

Linearity Test

1. Calculate the Mean of the four wells for each concentration in columns 1-5.
2. Perform linear regression using these values as inputs:

x	y
1000	Mean of the 1000 pM wells
500	Mean of the 500 pM wells
250	Mean of the 250 pM wells
125	Mean of the 125 pM wells
62.5	Mean of the 62.5 pM wells

3. Calculate the R-Squared value; it must be ≥ 0.950 to pass.

Fluorescence Polarization (FP) Test

1. Using the raw data from the Parallel read:
 - Calculate the Mean Blank (wells A6-H6).
 - Calculate the Signal for each HPR well: Subtract the Mean Blank from its measurement value.
 - Calculate the Signal for each LPR well: Subtract the Mean Blank from its measurement value.
2. Using the raw data from the Perpendicular read:
 - Calculate the Mean Blank (wells A6-H6).
 - Calculate the Signal for each HPR well: Subtract the Mean Blank from its measurement value.
 - Calculate the Signal for each LPR well: Subtract the Mean Blank from its measurement value.
3. Calculate the G-Factor for each LPR well:

$$(\text{Parallel LPR Signal} * (1-0.02)) / (\text{Perpendicular LPR Signal} * (1+0.02))$$
4. Calculate the Mean G-Factor.
5. Calculate the Polarization value in mP for each HPR well (“PHPR”):

$$\frac{\text{Parallel HPR Signal} - \text{Mean G-Factor} * \text{Perpendicular HPR Signal}}{\text{Parallel HPR Signal} + \text{Mean G-Factor} * \text{Perpendicular HPR Signal}} * 1000$$
6. Calculate the Mean PHPR, in mP. This value must be > 340 mP to pass.
7. Calculate the Polarization value in mP for each LPR well (“PLPR”):

$$\frac{\text{Parallel LPR Signal} - \text{Mean G-Factor} * \text{Perpendicular LPR Signal}}{\text{Parallel LPR Signal} + \text{Mean G-Factor} * \text{Perpendicular LPR Signal}} * 1000$$
8. Calculate the Standard Deviation of the “PLPR,” in mP. This value must be < 5 mP to pass.

Time-Resolved Fluorescence (TRF) Test

1. Calculate the Mean and Standard Deviation of the wells containing the deionized water (wells A6-H6).
2. Calculate the Mean and Standard Deviation of the wells containing the Europium solution (wells A8-B8).
3. Calculate the Detection Limit, in fM:

$$20000 / ((\text{Mean Eu} - \text{Mean DI water}) / (3 * \text{Standard Deviation DI water}))$$
 The Detection Limit must be < 250 fM to pass.

Troubleshooting Tips

If any tests fail, please try the suggestions below. If the test(s) continue to fail, print the results and contact BioTek's Technical Assistance Center.

- Are the solutions fresh? Unless otherwise indicated, once mixed (or opened, if purchased from the manufacturer), the buffer and stock solutions should be discarded after seven days.
- Are the Excitation/Emission filters clean? Are they in the proper locations and in the proper orientation in the filter wheels?
- Are you using new/clean plates? We suggest you re-run the test with a new/clean microplate. If the base of a clear plate is touched, clean the entire base with alcohol (95% ethanol) and then wipe with a lint-free cloth. Before placing a plate in the instrument, blow the bottom of the plate with an aerosol. If the test fails again, the optical probe(s) may need to be cleaned. Contact BioTek TAC for instructions.
- When performing the Fluorescence Intensity tests, if a test fails because one or more wells overranged, reduce the Sensitivity value in the Gen5 protocol by 1-5 counts and re-read the plate.
- If the Corners Test continues to fail, the hardware may be misaligned. Contact BioTek TAC.
- Review the instructions under "Pipette Maps" (starting on page 105) to verify that you correctly prepared the plates.
- Does the Plate Type setting in the Gen5 protocol match the plate you used?
- For injector models, spilled fluid inside the reader may be fluorescing, corrupting your test results. Clean the internal components according to the instructions in **Chapter 6, Preventive Maintenance**, and re-run the tests.
- When testing the Fluorescence Polarization module using a solid black plastic microplate, if the standard deviation for the buffer wells is too high, try either moving the buffer wells to another column, or using the Greiner SensoPlate. With some black plastic plates, the wells in the center of the plate may be slightly distorted due to the plate molding process, and this can affect the standard deviation.

Gen5 Protocol Reading Parameters

Create Gen5 protocols to test your reader's configuration:

Protocol Name	Purpose
FI_B.prt	Fluorescence Intensity tests (Corners, Sensitivity, Linearity), using the BOTTOM optics
FI_T.prt	Fluorescence Intensity tests (Corners, Sensitivity, Linearity), using the TOP optics
FP.prt	Fluorescence Polarization test
TRF.prt	Time-Resolved Fluorescence test

The information in the following tables represents the *recommended* reading parameters. Your tests may require modification to some of these parameters, such as the Plate Type or Sensitivity (see **Troubleshooting Tips** on page 110).

❖ The Plate Type setting in each Gen5 protocol should match the plate you are actually using.

Protocol Name: FI_B.prt	
A procedure with two Read steps to test the bottom optics: one for the Corners Test and one for the Sensitivity/Linearity Tests. All reading parameters are the same for both Read steps, with the exceptions noted below.	
Parameter	Setting
Plate Type:	"Greiner SensoPlate" (#655892)
Read Step Label:	Corners Read step: "Corners Read" Sensitivity/Linearity Read step: "Sensitivity Read"
Detection Method:	Fluorescence
Read Type:	Endpoint
Read Speed:	Normal
Delay After Plate Movement:	350 msec
Measurements Per Data Point:	40
Read Wells:	Corners Read step: Full plate Sensitivity/Linearity Read step: Wells C1 to F12
Light Source:	Tungsten
Filter Sets:	1
Filters:	EX 485/20 nm, EM 528/20 nm
Optics Position:	Bottom
Sensitivity:	Corners Read step: 80 Sensitivity/Linearity Read step: 100

Protocol Name: FI_T.prt	
A procedure with two Read steps to test the top optics: one for the Corners Test and one for the Sensitivity/Linearity Tests. All reading parameters are the same for both Read steps, with the exceptions noted below.	
Parameter	Setting
Plate Type:	"Costar 96 black opaque" (#3915)
Read Step Label:	Corners Read step: "Corners Read" Sensitivity/Linearity Read step: "Sensitivity Read"
Detection Method:	Fluorescence
Read Type:	Endpoint
Read Speed:	Normal
Delay After Plate Movement:	350 msec
Measurements Per Data Point:	40
Read Wells:	Corners Read step: Full plate Sensitivity/Linearity Read step: Wells C1 to F12
Light Source:	Tungsten
Filter Sets:	1
Filters:	EX 485/20 nm, EM 528/20 nm
Optics Position:	Top 510 nm
Sensitivity:	Corners Read step: 75 Sensitivity/Linearity Read step: 75
Top Probe Vertical Offset:	5.00 mm

Protocol Name: FP.prt	
A procedure with one Read step with Polarization enabled, inside a Plate Mode block.	
Parameter	Setting
Plate Type:	"Costar 96 black opaque" (#3915)
Synchronized Mode:	Plate Mode with Timing Control
Detection Method:	Fluorescence
Read Type:	Endpoint
Read Speed:	Normal
Delay After Plate Movement:	350 msec
Measurements Per Data Point:	60
Read Wells:	A5-H9
Polarization:	Enabled
Light Source:	Tungsten
Filters:	EX 485/20 nm, EM 528/20 nm
Optics Position:	Top 510 nm
Sensitivity:	100
Top Probe Vertical Offset:	5.00 mm

Protocol Name: TRF.prt	
A procedure with one Read step with Time-Resolved enabled.	
Parameter	Setting
Plate Type:	"Costar 96 white opaque" (#3912)
Delay Step:	3 minutes
Shake Step:	30 seconds at Medium intensity
Detection Method:	Fluorescence
Read Type:	Endpoint
Read Speed:	Normal
Delay After Plate Movement:	350 msec
Measurements Per Data Point:	20
Read Wells:	A5-H9
Time-Resolved:	Enabled
Delay Before Collecting Data:	300 µsec
Data Collection Time:	1000 µsec
Light Source:	Xenon Flash
Filter Sets:	1
Filters:	EX 360/40 nm, EM 620/40 nm
Optics Position:	Top 400 nm
Sensitivity:	125
Top Probe Vertical Offset:	5.00 mm

Fluorescence Tests Using Methylumbelliferone

As an alternative to using Sodium Fluorescein, Methylumbelliferone (“MUB”) can be used to test the top optics.

Required Materials

- ❖ BioTek offers test kits containing the microplates and solutions used in fluorescence liquid test procedures; see page 23.
- ❖ Microplates should be perfectly clean and free from dust or bottom scratches. Use new microplates from sealed packages.
- ❖ Manufacturer part numbers are subject to change.

- Methylumbelliferone (“MUB”) (10-mg vial, BioTek PN 98156)
- Carbonate-Bicarbonate buffer (“CBB”) capsules (BioTek PN 98158)
- 100% methanol (BioTek PN 98161)
- A new, clean, 96-well solid black microplate, such as Corning® Costar #3915 (or equivalent)
- Excitation filter 360/40 nm, Emission filter 460/40 nm
- 50% mirror installed
- Deionized or distilled water
- Various beakers, graduated cylinders, and pipettes
- Aluminum foil
- (Optional, but recommended) 0.45 micron filter
- (Optional) Black polyethylene bag(s) to temporarily store plate(s)
- Gen5 protocol **FI_MUB.prt** described on page 118

Test Solutions



Filter solutions to remove particulates that could cause erroneous readings. Do not allow dust to settle on the surface of the solution; use microplate covers or seals when not reading the plate.

Wrap the vial containing the MUB stock solution in foil to prevent exposure to light.

Discard any open, unused solutions after seven days.

1. Prepare the buffer (CBB) solution:
 - (Optional, but recommended) Using a 0.45-micron filter, filter 200 mL of deionized or distilled water.
 - Open and dissolve the contents of 2 CBB capsules (do not dissolve the outer gelatin capsule) into 200 mL of the water.
 - Stir the solution (preferably using a stir table) until the CBB is completely dissolved.
2. Prepare the MUB stock solution:
 - Add 1 mL of 100% methanol to the 10 mg vial of MUB.
 - Make sure all of the dye has completely dissolved and is well mixed. This yields a 10 mg/mL stock solution.
 - Wrap the solution in aluminum foil to prevent exposure to light.
3. Prepare the dilutions. Label each with “MUB” and the concentration:

Mix this MUB solution:	with:	to make:
0.5 mL of 10 mg/mL stock solution	4.5 mL of 100% methanol	1 mg/mL
0.88 mL of 1 mg/mL solution	4.12 mL of CBB	176 µg/mL
0.1 mL of 176 µg/mL solution	9.9 mL of CBB	1.76 µg/mL
0.5 mL of 1.76 µg/mL solution	4.5 mL of CBB	176 ng/mL
1 mL of 176 ng/mL solution	9 mL of CBB	17.6 ng/mL (100 nM)

Procedure

1. If you have not already done so, prepare the test solutions. See page 114.
2. Perform the Sensitivity/Linearity tests using the Top optics:
 - Refer to **Pipette Map** on the next page and pipette the solutions into a clean, 96-well solid black plate.
 - Create a Gen5 experiment based on the **FI_MUB.prt** protocol and read the plate.
3. Calculate and evaluate results as described under **Results Analysis** on page 117.

Pipette Map

❖ Seal the plate with foil or store it in black polyethylene bags until use.

Use a multi-channel pipette with 4 tips installed to process **rows C-F**:

- Pipette 150 μL of buffer into columns 10-12.
- Pipette 150 μL of buffer into columns 2-5 (not column 1).
- Discard the tips.
- Pipette 150 μL of the **17.6 ng/mL (100 nM)** MUB solution into column 1. Discard the tips.
- Pipette 150 μL of the **17.6 ng/mL (100 nM)** MUB solution into column 2. Do not discard the tips.
- Aspirate 150 μL from column 2 and dispense it into column 3. Mix the wells using the pipette. Do not discard the tips.
- Aspirate 150 μL from column 3 and dispense it into column 4. Mix the wells using the pipette. Do not discard the tips.
- Aspirate 150 μL from column 4 and dispense it into column 5. Mix the wells using the pipette. Do not discard the tips.
- Aspirate 150 μL from column 5 and discard the fluid and tips.

	1	2	3	4	5	6	7	8	9	10	11	12
A												
B												
C	100 nM	50 nM	25 nM	12.5 nM	6.25 nM					BUF	BUF	BUF
D	100 nM	50 nM	25 nM	12.5 nM	6.25 nM					BUF	BUF	BUF
E	100 nM	50 nM	25 nM	12.5 nM	6.25 nM					BUF	BUF	BUF
F	100 nM	50 nM	25 nM	12.5 nM	6.25 nM					BUF	BUF	BUF
G												
H												

Results Analysis

Sensitivity Test

1. Calculate the Mean and Standard Deviation for the buffer wells (C10-F12).
2. Calculate the Mean for the 17.6 ng/mL (100 nM) MUB solution wells (C1-F1).
3. Calculate the Detection Limit, in ng/mL:

$$17.6 / ((\text{Mean MUB} - \text{Mean Buffer}) / (3 * \text{Standard Deviation Buffer}))$$

For the Top probe with the 50% mirror, the Detection Limit must be < 0.16 ng/mL to pass.

Linearity Test

1. Calculate the Mean of the four wells for each concentration in columns 1-5.
2. Perform linear regression using these values as inputs:

x	y
100	Mean of the 100 nM wells
50	Mean of the 50 nM wells
25	Mean of the 25 nM wells
12.5	Mean of the 12.5 nM wells
6.25	Mean of the 6.25 nM wells

3. Calculate the R-Squared value; it must be ≥ 0.950 to pass.

Gen5 Protocol Reading Parameters

The information below represents the *recommended* reading parameters. Your tests may require modification to some of these parameters, such as the Plate Type or Sensitivity (see **Troubleshooting Tips** on page 110).

❖ The Plate Type setting in the Gen5 protocol should match the plate you are actually using.

Protocol Name: FI_MUB.prt	
Parameter	Setting
Plate Type:	"Costar 96 black opaque" (#3915)
Detection Method:	Fluorescence
Read Type:	Endpoint
Read Speed:	Normal
Delay After Plate Movement:	350 msec
Measurements Per Data Point:	40
Dynamic Range:	Standard
Read Wells:	C1-F12
Light Source:	Tungsten
Filter Sets:	1
Filters:	EX 360/40 nm, EM 460/40 nm
Optics Position:	Top 50% Mirror
Sensitivity:	90
Top Probe Vertical Offset:	5.00 mm

Luminescence Test

This section only applies to models with the Luminescence module.

For Synergy 2 models with luminescence capability, BioTek provides two methods for verifying the performance of the luminescence module.

One method measures a Harta Luminometer Reference Microplate, which is an LED-based test plate. Contact BioTek to purchase a plate, or go to www.hartainstruments.com for more information. The other method measures a LUX Biotechnology, Ltd., Glowell unit, which is a small, sealed cylinder with a gaseous tritium light source.

Harta Plate Test

Materials

- Luminometer Reference Microplate and Adapter, BioTek PN 8030015
- Gen5 protocol **LumTest_Harta.prt** (see page 123)

Procedure

1. Turn on the Harta reference plate using the I/O switch on the back of the plate.
2. Check the plate's battery by pressing simultaneously on the two test buttons on the back of the plate and ensuring that the test light turns on.
3. Place the Harta plate adapter on the reader's carrier, then place the test plate on top of the adapter.
4. Create an experiment based on the **LumTest_Harta.prt** protocol and read the plate.
5. Calculate and evaluate results as described under **Results Analysis** on page 120.

Plate Map

	1	2	3	4	5	6	7	8	9	10	11	12
A		A2 meas					battery check	battery check				
B												
C												
D												
E												
F	buffer	buffer	buffer	buffer	buffer	buffer	buffer	buffer	buffer	buffer	buffer	buffer
G	buffer	buffer	buffer	buffer	buffer	buffer	buffer	buffer	buffer	buffer	buffer	buffer
H												

Results Analysis

❖ A manual ATP correlation process determined that 11,000 RLU from the Harta plate is equivalent to approximately 1800 attomoles of ATP.

1. On the Harta plate's Calibration Certificate, locate the NIST measurement for the A2 position and convert it to attomoles:

$$(A2 \text{ NIST measurement}/11,000)*1800$$

2. Determine if the plate's battery is still functioning properly:

- If $A8 > A7$, the battery is good
- If $A8 < A7$, the battery requires replacement

3. Calculate the signal-to-noise ratio:

$$(A2 - \text{Mean of the buffer cells})/(3 * \text{Standard deviation of buffer cells})$$

4. Calculate the detection limit:

$$A2 \text{ NIST measurement in attomoles}/\text{signal-to-noise ratio}$$

- If the reader is equipped with the low-noise PMT, the detection limit must be $< 50 \text{ amol}$ for the test to pass.
- If the reader is equipped with the red-shifted PMT, the detection limit must be $< 500 \text{ amol}$ for the test to pass.
- To determine which PMT is installed, check the label on the side of the reader. #49984 = low noise PMT, #49721 = red-shifted.

Glowell Test

Materials

- Glowell, PN GLO-466, formerly available from LUX BioTechnology, Ltd.
- Glowell Adapter Plate, available from BioTek, PN 7160006
- Gen5 protocol **LumTest.prt** (see page 122)

Procedure

1. If you have not already done so, insert the Glowell ("window" side up) into well D8 of the Adapter Plate.
2. If you have not already done so, create the Gen5 protocol as described on page 122.
3. Create an experiment based on the LumTest.prt protocol. Read the plate and then save the experiment.
4. Calculate and evaluate results as described under **Results Analysis** on page 121.

Results Analysis

❖ A manual ATP correlation process determined that 0.021 pW Radiant Flux is equivalent to approximately 1800 attomoles of ATP.

1. Locate these items on the Glowell's Calibration Certificate: Calibration Date, Radiant Flux (pW), Measurement Uncertainty of the Radiant Flux.
2. Calculate the number of days between the Calibration Date and the date the test was performed.
3. Correct the Glowell's Radiant Flux value for deterioration over time:

$$\text{Radiant Flux} * e^{(-0.0001536 * \text{number of days since calibration})}$$
4. Convert the Corrected Radiant Flux value to attomoles:

$$(\text{Corrected Radiant Flux} / 0.021) * 1800$$
5. Calculate an error factor for the Corrected Radiant Flux (amol):

$$(\text{Corrected Radiant Flux in amol} * \text{Measurement Uncertainty}) / 100$$
6. Calculate the min/max criteria for the Corrected Radiant Flux (amol):
 MIN: Corrected Radiant Flux in amol – Error Factor
 MAX: Corrected Radiant Flux in amol + Error Factor
7. Calculate the Signal-to-Noise Ratio:

$$\frac{\text{Measurement value of the Glowell} - \text{Mean of Column 9}}{3 \times \text{Standard Deviation of Column 9}}$$
8. Calculate the Detection Limit:

$$\text{Corrected Radiant Flux in amol} / \text{Signal-to-Noise Ratio}$$
9. Calculate the min/max criteria for the Detection Limit:
 MIN: MIN for Corrected Radiant Flux in amol / Signal-to-Noise Ratio
 MAX: MAX for Corrected Radiant Flux in amol / Signal-to-Noise Ratio
 - If the reader is equipped with the low-noise PMT, both of these values must be < 50 amol for the test to pass.
 - If the reader is equipped with the red-shifted PMT, both of these values must be < 500 amol for the test to pass.
 - To determine which PMT is installed, check the label on the side of the reader. #49984 = low noise PMT, #49721 = red-shifted.

Troubleshooting

If the test fails, please try the suggestions below. If the tests continue to fail, print the results and contact BioTek's Technical Assistance Center.

- Ensure that the reading is performed through a hole in the EM filter wheel, not through a glass filter.
- Verify that the filter wheel settings in Gen5 match the physical wheel.
- If the test continues to fail, the optical probe(s) *may* need to be cleaned. Contact BioTek TAC for instructions.

Glow ell only:

- Is the Glowell properly inserted into the adapter? The “window” side should be facing up. If necessary, clean the Glowell according to the manufacturer's instructions.
- Is the adapter plate clean? If dust has collected in the wells, try cleaning the plate using compressed air or an aerosol duster.
- Is the test failing because the standard deviation of the empty background wells is 0 (resulting in a division-by-zero error when calculating the Signal-to-Noise Ratio)? If yes, try pipetting 100 μ L of deionized water into all wells of Columns 9, 10, and 11 (the background wells).

Gen5 Protocol Reading Parameters

The information in the following tables represents the recommended reading parameters.

Protocol Name: LumTest.prt (Glow ell)	
Parameter	Setting
Plate Type:	“Costar 96 black opaque”
Delay Step:	3 minutes
Detection Method:	Luminescence
Read Type:	Endpoint
Integration Time:	0:10.00 MM:SS:ss
Delay After Plate Movement:	350 msec
Dynamic Range:	Standard
Read Wells:	A8-A11
Emission:	Hole
Optics Position:	Top
Sensitivity:	150
Top Probe Vertical Offset:	1.00 mm

Protocol Name: LumTest_Harta.prt	
Parameter	Setting
Plate Type:	"Costar 96 black opaque"
Delay Step:	3 minutes
READ STEP 1	
Label:	"Reference well A2"
Read Wells:	A2
Detection Method:	Luminescence
Read Type:	Endpoint
Integration Time:	0:10.00 MM:SS:ss
Delay After Plate Movement:	350 msec
Dynamic Range:	Standard
Emission:	Hole
Optics Position:	Top
Sensitivity:	150
Top Probe Vertical Offset:	5.00 mm
READ STEP 2	
Label:	"Background"
Read Wells:	F1-G12
Detection Method:	Luminescence
Read Type:	Endpoint
Integration Time:	0:10.00 MM:SS:ss
Delay After Plate Movement:	350 msec
Dynamic Range:	Standard
Emission:	Hole
Optics Position:	Top
Sensitivity:	150
Top Probe Vertical Offset:	4.00 mm
READ STEP 3	
Label:	"Battery Check"
Read Wells:	A7-A8
Detection Method:	Luminescence
Read Type:	Endpoint
Integration Time:	0:01.00 MM:SS:ss
Delay After Plate Movement:	350 msec
Dynamic Range:	Standard
Emission:	Hole
Optics Position:	Top
Sensitivity:	50
Top Probe Vertical Offset:	5.00 mm

Dispense Module Tests

This section only applies to models with injectors.

BioTek developed a set of tests that you can perform to ensure that the dispense module performs to specification initially and over time. We recommend that you perform these tests before first use (e.g., during the Initial OQ), and then every three months.

- The **Accuracy Test** is a measure of the mean volume per well for multiple dispenses. The actual weight of the dispensed fluid is compared to the expected weight and must be within a certain percentage to pass. Pass/Fail criteria depends on the per-well volume dispensed: 2.0% for 80 μ L, 5.0% for 20 μ L, and 20.0% for 5 μ L. It is assumed that one gram is equal to one milliliter.

The test uses a green dye test solution and one 96-well microplate (per injector) to test the three different volumes. The balance is tared with the empty plate, and then the 80 μ L dispense is performed for columns 1-4. The fluid is weighed and the balance is tared again (with the plate on the balance). This process is repeated for the 20 μ L and 5 μ L dispenses.

- The **Precision Test** is a measure of the variation among volumes dispensed to multiple wells. For each volume dispensed (80/20/5 μ L) to four columns, the coefficient of variation of 32 absorbance readings is calculated. Pass/Fail criteria depends on the per-well volume dispensed: 2.0% for 80 μ L, 7.0% for 20 μ L, and 10.0% for 5 μ L. The plate is read in an absorbance reader at 405/750 nm for columns 1-4 and at 630/750 nm for columns 5-12.

The two tests are performed simultaneously and use the same plate.



Each dispense module is calibrated to perform with a specific reader. Make sure the dispense module and reader have the same serial number.

Required Materials

- Absorbance reader with 405, 630, and 750 nm filters. The reader must have an accuracy specification of $\pm 1.0\% \pm 0.010$ OD or better and a repeatability specification of $\pm 1.0\% \pm 0.005$ OD or better.

❖ The Synergy 2 may be used if it is equipped with the Absorbance module and has passed the Absorbance Plate Test and the Absorbance Liquid Tests.

- Microplate shaker (if the absorbance reader does not support shaking)
- Precision balance with capacity of 100 g minimum and readability of 0.001 g

- 50-200 μ L hand pipette and disposable tips
- Deionized water
- Supply bottles
- 250 mL beaker
- New 96-well, clear, flat-bottom microplates
- BioTek's Green Test Dye Solution (PN 7773003) undiluted, or one of the alternate test solutions listed in the next section
- 100 mL graduated cylinder and 10 mL pipettes (if not using BioTek's test solution)
- Gen5 protocols as defined by the procedure on page 129 or 131

Test Solutions

❖ 80 μ L of test solution with 150 μ L of deionized water should read between 1.300 and 1.700 OD at 405/750 nm. The solutions should be at room temperature.

If you do not have BioTek's Green Test Dye Solution (PN 7773003), prepare a green test dye solution using one of the following methods:

- Using BioTek's Blue and Yellow Concentrate Dye Solutions:

Ingredient	Quantity
Concentrate Blue Dye Solution (PN 7773001; 125 mL)	4.0 mL
QC (Yellow) Solution (PN 7120782; 125 mL)	5.0 mL
Deionized water	90.0 mL

- Using FD&C Blue and Yellow Dye Powder:

Ingredient	Quantity per Liter
FD&C Blue #1	0.200 g
FD&C Yellow #5	0.092 g
Tween [®] 20	1.0 mL
Sodium Azide N ₃ Na	0.010 g
Deionized water	Make to 1 liter

Procedure for Models with the Absorbance Module

1. If you have not already done so, create Gen5 protocols **Disp 1 Test.prt** and **Disp 2 Test.prt**. Instructions begin on page 129.
2. Prime both dispensers with 4000 μL of deionized or distilled water.
3. Remove the inlet tubes from the supply bottles. Prime both dispensers with the Volume set to 2000 μL . This prevents the water from diluting the dye.
4. Fill a beaker with at least 20 mL of the green dye solution. Prime both dispensers with 2000 μL of the solution. When finished, remove the priming plate from the carrier.
5. In Gen5, create an experiment based on the **Disp 1 Test** protocol.
6. Place a new 96-well microplate on the balance and tare the balance.
7. Place the plate on the microplate carrier.

❖ When each dispense step is finished, you will weigh the plate, record the weight, tare the balance with the plate on it, and then place the plate back on the carrier for the next step.
8. Select Plate > Read and click READ. Gen5 will prompt you to empty the tip priming trough.
9. When ready, click OK to begin the experiment. The sequence is as follows:
 - Dispense 80 μL /well to columns 1-4.
 - Remove the plate and weigh it. Record the weight and tare the balance.
 - Place the plate on the carrier, dispense 20 μL /well to columns 5-8.
 - Remove the plate and weigh it. Record the weight and tare the balance.
 - Place the plate on the carrier, dispense 5 μL /well to columns 9-12.
 - Remove the plate and weigh it. Record the weight.
 - Manually pipette 150 μL of deionized or distilled water into all 12 columns, on top of the green test dye solution.
 - Place the plate on the carrier for a 15-second shake, the '80 μL ' read at 405/750 nm, and the '20 and 5 μL ' read at 630/750 nm.
10. When processing is complete, select File > Save As. Enter an identifying file name and click Save.
11. Remove the plate from the carrier and set it aside.
12. Repeat steps 5-11 using the **Disp 2 Test** protocol.
13. See page 128 for instructions for analyzing the results.
14. When all tests are complete, prime both dispensers with at least 5000 μL of deionized water, to flush out the green dye solution.

Procedure for Models without the Absorbance Module

❖ If you will not be using a BioTek absorbance reader for this procedure, prepare your reader to perform two reads with these characteristics:

	'80 μ L' Read	'20 & 5 μ L' Read
Primary wavelength:	405 nm	630 nm
Reference wavelength:	750 nm	750 nm
Plate columns:	1-4	5-12

1. If you have not already done so, create the necessary Gen5 protocols as described on page 131.
2. Prime both dispensers with 4000 μ L of deionized or distilled water.
3. Remove the inlet tubes from the supply bottles. Prime both dispensers with the Volume set to 2000 μ L. This prevents the water from diluting the dye.
4. Fill a beaker with at least 20 mL of the green dye solution. Prime both dispensers with 2000 μ L of the solution. When finished, remove the priming plate from the carrier.
5. In Gen5, create an experiment based on the **Disp 1 Test** protocol.
6. Place a new 96-well microplate on the balance and tare the balance.
7. Place the plate on the microplate carrier.

❖ When each dispense step is finished, you will weigh the plate, record the weight, tare the balance with the plate on it, and then place the plate back on the carrier for the next step.

8. Select Plate > Read and click READ. Gen5 will prompt you to empty the tip priming trough.
9. When ready, click OK to begin the experiment. The sequence is as follows:
 - Dispense 80 μ L/well to columns 1-4.
 - Remove the plate and weigh it. Record the weight and tare the balance.
 - Place the plate on the carrier, dispense 20 μ L/well to columns 5-8.
 - Remove the plate and weigh it. Record the weight and tare the balance.
 - Place the plate on the carrier, dispense 5 μ L/well to columns 9-12.
 - Remove the plate and weigh it. Record the weight.
 - Manually pipette 150 μ L of deionized or distilled water into all 12 columns, on top of the green test dye solution.
 - Carefully set the plate aside.

10. Close the experiment without saving it.

❖ If you are not using a BioTek reader for the absorbance measurements, read the plate using the wavelengths shown in the table on the previous page and then proceed to Results Analysis below.

11. Configure Gen5 to communicate with the BioTek absorbance reader.

12. Create an experiment based on the **Disp 1 Test Other Reader** protocol.

13. Select **Plate > Read** and click **READ**. Place the plate on the carrier and click **OK**.

The absorbance reader will:

- Shake the plate for 15 seconds.
- Perform the '80 μL ' read at 405/750 nm.
- Perform the '20 and 5 μL ' read at 630/750 nm.

14. When processing is complete, select **File > Save As**. Enter an identifying file name and click **Save**.

15. Repeat steps 5-14 using the **Disp 2 Test** protocol for the dispense portion.

16. See the instructions below for analyzing the results.

17. When all tests are complete, prime both dispensers with at least 5000 μL of deionized water, to flush out the green dye solution.

Results Analysis

❖ Worksheets are included at the end of this chapter for recording the dispense weights, Delta OD values, calculations, and pass/fail.

For each volume dispensed (80, 20, 5 μL), for each dispenser (1, 2):

- Calculate the Standard Deviation of the 32 wells
- Calculate the Mean of the 32 wells
- Calculate the %CV: $(\text{Standard Deviation} / \text{Mean}) \times 100$
- Calculate the Accuracy % Error:
 $((\text{Actual Weight} - \text{Expected Weight}) / \text{Expected Weight}) \times 100$

❖ Expected Weights for 32 wells: 80 μL (2.560 g), 20 μL (0.640 g), 5 μL (0.160 g). It is assumed that one gram is equal to one milliliter.

Dispense Volume	To pass, % CV must be:	To pass, Accuracy % Error must be:
80 μL	$\leq 2.0\%$	$\leq 2.0\%$
20 μL	$\leq 7.0\%$	$\leq 5.0\%$
5 μL	$\leq 10.0\%$	$\leq 20.0\%$

Failures

If any tests fail, prime the fluid lines and re-run the test(s). If the test(s) fail again:

- The injector heads may require cleaning (see **Chapter 6, Preventive Maintenance**).
- Each dispense module is factory-calibrated for the reader it ships with. Verify that the serial number on the dispense module matches the serial number on the reader. Even if the serial numbers match, it is still possible that the calibration values have been inadvertently changed. Contact BioTek's Technical Assistance Center.

If tests continue to fail, contact BioTek's Technical Assistance Center.

Gen5 Test Protocols for Models with the Absorbance Module

❖ Perform these steps to create a protocol to test Dispenser 1. Then, open a copy of the protocol and change the relevant Procedure parameters for Dispenser 2.

1. In Gen5, create a new Synergy 2 protocol.
2. Define the **Procedure** with the steps and settings as described in this table:

#	Step Type	Details
1	Dispense	Dispenser <select 1 or 2, depending on the protocol> Dispense to wells A1..H4 Tip prime before this dispense step, 20 µl Dispense 80 µl at rate 275 µl/sec
2	Plate Out,In	Suggested comment: Weigh the plate (80 ul test). RECORD the weight, TARE the balance. Place the plate back on the carrier. Click OK to continue.
3	Dispense	Dispenser <select 1 or 2, depending on the protocol> Dispense to wells A5..H8 Tip prime before this dispense step, 20 µl Dispense 20 µl at rate 250 µl/sec
4	Plate Out,In	Suggested comment: Weigh the plate (20 ul test). RECORD the weight, TARE the balance. Place the plate back on the carrier. Click OK to continue.
5	Dispense	Dispenser <select 1 or 2, depending on the protocol> Dispense to wells A9..H12 Tip prime before this dispense step, 5 µl Dispense 5 µl at rate 225 µl/sec
6	Plate Out,In	Suggested comment: Weigh the plate (5 ul test). RECORD the weight. PIPETTE 150 ul/well of DI water into all 12 columns. Place the plate back on the carrier. Click OK to perform the Read steps.
7	Shake	Medium intensity for 15 seconds

#	Step Type	Details
8	Read	Step label: "80 ul Read_Disp 1" (or _Disp 2) Wells: A1..H4 Detection Method: Absorbance Read Type: Endpoint Read Speed: Normal Two Wavelengths: 405 and 750 nm
9	Read	Step label: "20 and 5 ul Read_Disp 1" (or _Disp 2) Wells: A5..H12 Detection Method: Absorbance Read Type: Endpoint Read Speed: Normal Two Wavelengths: 630 and 750 nm

3. Create **Data Reduction** steps to calculate Delta OD values:
 - Open the Data Reduction dialog and click Transformation.
 - Click Select Multiple Data Sets and then click DS2.
 - Set the Data In for DS1 to the 80 μ L Read step at 405 nm.
 - Set the Data In for DS2 to the 80 μ L Read step at 750 nm.
 - Click OK to return to the Transformation dialog.
 - In the New Data Set Name field, type an identifying name such as 'Delta OD 80 ul_Disp 1'.
 - Clear Use single formula for all wells.
 - In the Current Formula field, type **DS1-DS2** and then highlight wells A1 to H4 to assign the formula.
 - Click OK to add the transformation to the Data Reduction list.
 - Create another Transformation similar to the above, with these characteristics:
 - DS1 set to the 20 and 5 μ L Read step at 630 nm
 - DS2 set to the 20 and 5 μ L Read step at 750 nm
 - New Data Set Name resembling 'Delta OD 20 and 5 ul_Disp 1'
 - Remember to clear 'Use Single Formula...'
 - Formula DS1-DS2 applied to wells A5 to H12
4. (This step is optional.) The results analysis worksheet at the end of this chapter requires the calculation of the Standard Deviation, Mean, and % CV of the ODs read for each dispense volume in each plate (six sets of calculations). By identifying the wells by their dispense volumes in the **Plate Layout**, Gen5 will calculate these values for you.
 - Open the Plate Layout dialog.

- Define three Assay Control names as **Disp_80**, **Disp_20**, and **Disp_5**.
- Assign Disp_80 to wells A1 to H4.
- Assign Disp_20 to wells A5 to H8.
- Assign Disp_5 to wells A9 to H12.

❖ After running the experiment, view the Statistics for each Delta OD Data Set to view the calculations.

5. Save the protocols as **Disp 1 Test.prt** and **Disp 2 Test.prt**.

Gen5 Test Protocols for Models without the Absorbance Module

The test procedure on page 127 dispenses three volumes of fluid to a microplate and then reads the plate on an absorbance reader. The procedure is performed twice, once for each dispenser. You will create two Gen5 protocols to perform the dispense steps. If you will use a BioTek absorbance reader that is supported by Gen5, you will create one additional protocol to perform the Read steps.

Create the Dispense Protocols

❖ Perform these steps to create a protocol to test Dispenser 1. Then, open a copy of the protocol and change the relevant Procedure parameters for Dispenser 2.

1. In Gen5, create a new Synergy 2 protocol.
2. Define the **Procedure** with the steps and settings as described in this table:

#	Step Type	Details
1	Dispense	Dispenser <select 1 or 2, depending on the protocol> Dispense to wells A1..H4 Tip prime before this dispense step, 20 µl Dispense 80 µl at rate 275 µl/sec
2	Plate Out,In	Suggested comment: Weigh the plate (80 ul test). RECORD the weight, TARE the balance. Place the plate back on the carrier. Click OK to continue.
3	Dispense	Dispenser <select 1 or 2, depending on the protocol> Dispense to wells A5..H8 Tip prime before this dispense step, 20 µl Dispense 20 µl at rate 250 µl/sec
4	Plate Out,In	Suggested comment: Weigh the plate (20 ul test). RECORD the weight, TARE the balance. Place the plate back on the carrier. Click OK to continue.
5	Dispense	Dispenser <select 1 or 2, depending on the protocol> Dispense to wells A9..H12 Tip prime before this dispense step, 5 µl Dispense 5 µl at rate 225 µl/sec

#	Step Type	Details
6	Plate Out,In	Suggested comment: Weigh the plate (5 ul test). RECORD the weight. Set the plate aside and click OK.
7	Read	Wells: A1 Detection Method: <select any valid method> Read Type: Endpoint Read Speed: Normal Wavelength: <select any valid wavelength(s)>
The Read step is necessary because Gen5 requires a Read step within any Dispense procedure. When the test is run, the measurement value is not used.		

3. Save the protocols as **Disp 1 Test.prt** and **Disp 2 Test.prt**.

Create the Read Protocol (if needed)

1. In Gen5, create a new Synergy 2 protocol.
2. Define the **Procedure** with the steps and settings as described in this table:

#	Step Type	Details
1	Shake	Medium intensity for 15 seconds
2	Read	Step label: "80 ul Read" Wells: A1..H4 Detection Method: Absorbance Read Type: Endpoint Read Speed: Normal Two Wavelengths: 405 and 750 nm
3	Read	Step label: "20 and 5 ul Read" Wells: A5..H12 Detection Method: Absorbance Read Type: Endpoint Read Speed: Normal Two Wavelengths: 630 and 750 nm

3. Create **Data Reduction** steps to calculate Delta OD values:
 - Open the Data Reduction dialog and click Transformation.
 - Click Select Multiple Data Sets and then click DS2.
 - Set the Data In for DS1 to the 80 µL Read step at 405 nm.
 - Set the Data In for DS2 to the 80 µL Read step at 750 nm.
 - Click OK to return to the Transformation dialog.
 - In the New Data Set Name field, type an identifying name such as 'Delta OD 80 ul_Disp 1'.
 - Clear Use single formula for all wells.

- In the Current Formula field, type **DS1-DS2** and then highlight wells A1 to H4 to assign the formula.
 - Click OK to add the transformation to the Data Reduction list.
 - Create another Transformation similar to the above, with these characteristics:
 - DS1 set to the 20 and 5 μ L Read step at 630 nm
 - DS2 set to the 20 and 5 μ L Read step at 750 nm
 - New Data Set Name resembling 'Delta OD 20 and 5 ul_Disp 1'
 - Remember to clear 'Use Single Formula...'
 - Formula DS1-DS2 applied to wells A5 to H12
4. (This step is optional.) The results analysis worksheet at the end of this chapter requires the calculation of the Standard Deviation, Mean, and % CV of the ODs read for each dispense volume in each plate (six sets of calculations). By identifying the wells by their dispense volumes in the **Plate Layout**, Gen5 will calculate these values for you.
- Open the Plate Layout dialog.
 - Define three Assay Control names as **Disp_80**, **Disp_20**, and **Disp_5**.
 - Assign Disp_80 to wells A1 to H4.
 - Assign Disp_20 to wells A5 to H8.
 - Assign Disp_5 to wells A9 to H12.

❖ After running the experiment, view the Statistics for each Delta OD Data Set to view the calculations.
--

5. Save the protocol as **Disp Test Other Reader.prt**.

Synergy 2 Dispense Accuracy & Precision Tests – Dispenser # 1

80 μ L Dispense Delta ODs @405/ 750 nm				
	1	2	3	4
A				
B				
C				
D				
E				
F				
G				
H				

80 μ L weight: g
 Expected weight: 2.5600 g

Accuracy % Error: %
 Must be \leq 2.0% P F

Standard Deviation:
 Mean:

% CV: %
 Must be \leq 2.0% P F

20 μ L Dispense Delta ODs @630/ 750 nm				
	5	6	7	8

20 μ L weight: g
 Expected weight: 0.6400 g

Accuracy % Error: %
 Must be \leq 5.0% P F

Standard Deviation:
 Mean:

% CV: %
 Must be \leq 7.0% P F

5 μ L Dispense Delta ODs @630/ 750 nm				
	9	10	11	12
A				
B				
C				
D				
E				
F				
G				
H				

5 μ L weight: g
 Expected weight: 0.1600 g

Accuracy % Error: %
 Must be \leq 20.0% P F

Standard Deviation:
 Mean:

% CV: %
 Must be \leq 10.0% P F

Reader Model: _____
 Reader S/N: _____
 Reading Date: _____
 Comments: _____

Tested By: _____
 Signature: _____

Reviewed/
 Approved By: _____
 Signature: _____

Synergy 2 Dispense Accuracy & Precision Tests – Dispenser # 2

80 µL Dispense Delta ODs @405/750 nm				
	1	2	3	4
A				
B				
C				
D				
E				
F				
G				
H				

80 µL weight: g

Expected weight: 2.5600 g

Accuracy % Error: %

Must be <= 2.0% P F

Standard Deviation:

Mean:

% CV: %

Must be <= 2.0% P F

20 µL Dispense Delta ODs @630/750 nm				
	5	6	7	8

20 µL weight: g

Expected weight: 0.6400 g

Accuracy % Error: %

Must be <= 5.0% P F

Standard Deviation:

Mean:

% CV: %

Must be <= 7.0% P F

5 µL Dispense Delta ODs @630/750 nm				
	9	10	11	12

5 µL weight: g

Expected weight: 0.1600 g

Accuracy % Error: %

Must be <= 20.0% P F

Standard Deviation:

Mean:

% CV: %

Must be <= 10.0% P F

Reader Model: _____
 Reader S/N: _____
 Reading Date: _____
 Comments: _____

Tested By: _____
 Signature: _____

Reviewed/
 Approved By: _____
 Signature: _____

Chapter 6

Preventive Maintenance

This chapter provides instructions for maintaining the reader and dispense module (if used) to ensure that they continue to perform to specification.

Preventive Maintenance	138
Warnings and Precautions	139
Clean Exposed Surfaces	141
Inspect/Clean Excitation and Emission Filters	141
Inspect/Clean Mirrors	142
Flush/Purge the Fluid Path	143
Run a Dispense Protocol (Optional)	144
Empty/Clean the Tip Priming Trough	145
Clean the Priming Plate	145
Clean the Internal Components	146

Preventive Maintenance

A general Preventive Maintenance regimen for all Synergy 2 models includes periodically cleaning all exposed surfaces and inspecting/cleaning the Emission and Excitation filters and dichroic mirrors (if equipped).

For models with the external dispense module, additional tasks include flushing/purging the fluid path, and cleaning the tip prime trough, priming plate, supply bottles, internal dispense tubing, and injectors.

Daily Cleaning for the Dispense Module

To ensure accurate performance and a long life for the dispense module and injectors, flush and purge the fluid lines with deionized (DI) water every day or after completing an assay run, whichever is more frequent. Some reagents may crystallize or harden after use and clog the fluid passageways. Take special care when using molecules that are active at very low concentrations (e.g., enzymes, inhibitors). Remove any residual reagent in the dispense lines using a suitable cleaning solution (review the reagent's package insert for specific recommendations).

Flushing the tubing at the end of each day, letting the DI water soak overnight, and then purging the lines at the beginning of each day ensures optimal performance of the dispense system. BioTek recommends performing a visual inspection of the dispense accuracy before running an assay protocol that includes dispense steps.

BioTek also recommends flushing the module with DI water before conducting the decontamination procedure described in **Chapter 7, As Needed Maintenance**.



Models with injectors: Accumulated algae, fungi, or mold may require decontamination. See **Chapter 7, As Needed Maintenance** for instructions.



Schedule

❖ The risk and performance factors associated with your assays may require performing some or all of the procedures more frequently than presented in the schedule.

Task	Page	Daily	Quarterly	As Needed
All models:				
Clean exposed surfaces	141			✓
Inspect/clean emission and excitation filters	141		✓	
Inspect/clean mirrors	142			<i>annually</i>
Decontamination	162	<i>before shipment and storage</i>		
Models with injectors only:				
Flush/purge the fluid path	143	✓		
(Optional) Run Dispense protocol	144			✓
Empty/clean tip prime trough	145	✓		
Clean priming plate	145			✓
Clean internal components	146		✓	✓

Warnings and Precautions

Read these warnings and precautions before performing maintenance procedures:

	Warning! Internal Voltage. Turn off and unplug the instrument for all maintenance and repair operations.
	Important! Do not immerse the instrument, spray it with liquid, or use a “wet” cloth on it. Do not allow water or other cleaning solution to run into the interior of the instrument. If this happens, contact BioTek’s Technical Assistance Center.
	Important! Do not apply lubricants to the microplate carrier or carrier track. Lubricant attracts dust and other particles, which may obstruct the carrier path and cause errors.

	<p>Warning! Wear protective gloves when handling contaminated instruments. Gloved hands should be considered contaminated at all times; keep gloved hands away from eyes, mouth, nose, and ears.</p>
	<p>Warning! Mucous membranes are considered prime entry routes for infectious agents. Wear eye protection and a surgical mask when there is a possibility of aerosol contamination. Intact skin is generally considered an effective barrier against infectious organisms; however, small abrasions and cuts may not always be visible. Wear protective gloves when handling contaminated instruments.</p>
	<p>Caution! The buildup of deposits left by the evaporation of spilled fluids within the read chamber can impact measurements. Be sure to keep System Test records before and after maintenance so that changes can be noted.</p>
	<p>Caution! Models with injectors. Before removing the reader's shroud to expose internal parts, purge the dispense module, turn off the instrument, and disconnect the fluid line, power cable, and PC cable.</p>
	<p>Warning! The Tungsten lamp assembly is hot when the instrument is powered on. If the instrument is on, turn it off and allow the lamp to cool down before attempting to replace it.</p>
	<p>Warning! Pinch Hazard. Some areas of the reader can present pinch hazards when the instrument is operating. These areas are marked with the symbol shown here. Keep hands/fingers clear of these areas when the instrument is operating.</p>

Clean Exposed Surfaces

Exposed surfaces may be cleaned (not decontaminated) with a cloth moistened (not soaked) with water or water and a mild detergent. You'll need:

- Deionized or distilled water
 - Clean, lint-free cotton cloths
 - Mild detergent (optional)
1. Important: Turn off and unplug the instrument.
 2. Moisten a clean cotton cloth with water, or with water and mild detergent. **Do not soak the cloth.**
 3. Wipe the plate carrier and all exposed surfaces of the instrument.
 4. Wipe all exposed surfaces of the dispense module (if used).
 5. If detergent was used, wipe all surfaces with a cloth moistened with water.
 6. Use a clean, dry cloth to dry all wet surfaces.

❖ Models with injectors: If the Tip Priming Trough overflows, wipe the carrier and the surface beneath the carrier with a dry cotton cloth. If overflow is significant, you may have to remove the reader's shroud and the incubator housing to access the surface beneath the carrier. See instructions starting on page 146.

Inspect/ Clean Excitation and Emission Filters

Laboratory air is used to cool the lamp, and the filters can become dusty as a result. The filters should be inspected and cleaned at least every three months. You'll need:

- Isopropyl, ethyl, or methyl alcohol
- 100% pure cotton balls or high-quality lens-cleaning tissue
- Cloth gloves
- Magnifying glass

❖ Do not touch the filters with your bare fingers.

1. Turn off and unplug the instrument.
2. Pull down the hinged door on the front of the instrument. Observe the two thumbscrews within the compartment. The left thumbscrew holds the excitation

- (EX) filter wheel in place; the right secures the emission (EM) filter wheel. Remove each thumbscrew and pull the filter wheel out of the compartment.
3. Inspect the filters for speckled surfaces or a “halo” effect. This may indicate deterioration due to moisture exposure over a long period of time. If you have any concerns about the quality of the filters, contact your BioTek representative.
 4. Using cotton balls or lens-cleaning tissue moistened with a small amount of high-quality alcohol, clean each filter by lightly stroking its surface in one direction. Ensure that the filters remain in their current locations.
 5. Use a magnifying glass to inspect the surface; remove any loose debris from the cotton ball.
 6. Replace the filter wheels in their respective positions and replace the thumbscrews. Close the hinged door.

Inspect/ Clean Mirrors

We recommend inspecting/cleaning the mirrors and polarizing filters (if equipped) annually, especially if the mirror holder has been handled or changed.

These optical elements are delicate and should be handled as carefully as possible. The glass and anti-reflective (AR) coated surfaces will be damaged by any contact, especially by abrasive particles. **In most cases, it is best to leave minor debris on the surface.** However, if performance indicators or obvious defects in the mirrors or filters suggest cleaning them, here are some guidelines:

- Use of oil-free dry air or nitrogen under moderate pressure is the best method for removing excessive debris from an optical surface. In the case that the contamination is not dislodged by the flow of gas, please follow the cleaning instructions below.

❖ All of the mirrors and filters can be easily damaged, especially the dichroic mirrors. Perform the cleaning steps only when necessary and always handle the mirror and filters carefully.

- The purpose of the cleaning solvent is only to dissolve any adhesive contamination that is holding the debris on the surface. The towel needs to absorb both the excessive solvent and entrap the debris so that it can be removed from the surface. Surface coatings on dichroics are typically less hard than the substrate. It is reasonable to expect that any cleaning will degrade the surface at an atomic level. Consideration should be given as to whether the contamination in question is more significant to the application than the damage that may result from cleaning the surface. In many cases, the AR coatings that are provided to give maximum light transmission amplify the appearance of contamination on the surface.

Materials

- Cloth gloves
- Anhydrous reagent-grade ethanol
- Kimwipes
- Magnifying glass
- 100% pure cotton balls (for the polarizing filters)

Procedure

1. Turn off the reader and remove its shroud (see page 85 for instructions).
2. Perform the steps in **Chapter 4, Filters and Mirrors** to remove the mirror holder.
3. Use absorbent towels such as Kimwipes, not lens paper, and wear gloves or use enough toweling so that solvents do not dissolve oils from your hands which can seep through the toweling onto the coated surface.
4. Wet the towel with an anhydrous reagent grade ethanol.
5. Drag the trailing edge of the ethanol soaked Kimwipe across the surface of the component, moving in a single direction. A minimal amount of pressure can be applied while wiping. However, too much pressure will damage the component.
6. Use the magnifying glass to inspect the surface, if debris is still visible, repeat with a new Kimwipe.
7. If equipped, clean the polarizing filters. Dampen a cotton ball with alcohol and gently stroke the surface of the filter to remove dust or fingerprints.
8. Reinstall the mirror holder and replace the shroud.

Flush/ Purge the Fluid Path

Applies only to models with injectors.

At the end of each day that the dispense module is in use, flush the fluid path using Gen5's priming utility. Leave the fluid to soak overnight or over a weekend, and then purge the fluid before using the instrument again.

❖ This flushing and purging routine is also recommended before disconnecting the outlet tubes from the back of the reader, and before decontamination to remove any assay residue prior to applying isopropyl alcohol or sodium hypochlorite.

To flush the fluid path:

1. Fill two supply bottles with deionized or distilled water. Insert the supply (inlet) tubes into the bottles.

2. Place the priming plate on the carrier.
3. Select System > Reader Control > Synergy 2 (Com<#>).
4. Click the Dispenser tab and select Dispenser 1.
5. Set the Volume to 5000 μL . Keep the default prime Rate.
6. Click Prime to start the process. When finished, carefully remove the priming plate from the carrier and empty it.
7. Repeat these steps for Dispenser 2.

Leave the water in the system overnight or until the instrument is used again. Purge the fluid from the system (see below) and then prime with the dispense reagent before running an assay.

To purge the fluid from the system:

1. Place the inlet tubes in empty supply bottles or a beaker.
2. Select System > Reader Control > Synergy 2 (Com<#>).
3. Click the Dispenser tab and select Dispenser 1.
4. Set the Volume to 2000 μL .
5. Click Purge to start the process. When finished, repeat these steps for Dispenser 2.

❖ After purging the system, you may wish to run a quick Dispense protocol to visually verify the dispense accuracy.

Run a Dispense Protocol (Optional)

Applies only to models with injectors.

After flushing/purging the system and before running an assay that requires dispense, take a moment to visually inspect the dispensing accuracy.

1. Create a new protocol in Gen5. Set the Plate Type to match the plate you will use.
2. Add a Dispense step with the following parameters:
 - Select Dispenser 1
 - Set Tip Priming to 'Before this dispense step' and Volume to 10 μL .
 - Set the Dispense Volume to 100 μL (or an amount to match your assay protocol).
 - Adjust the Rate to support the dispensing volume.
2. Add another Dispense step with the same parameters, selecting Dispenser 2.
3. Add a Read step with the following parameters (Gen5 requires a Read step in a Dispense protocol):

- Select any Detection Method
 - Set the Read Type to Endpoint
 - Click the Full Plate button and de-select the Use All Wells checkbox. This action leaves only well A1 selected for the Read.
 - Select any wavelength or define one Filter Set
3. Save the protocol using an identifying name, such as “Dispense Observation.”
 4. Fill the supply bottles with a DI H₂O-Tween solution (e.g., add 1 mL Tween® 20 to 1000 mL of deionized water).
 5. Create and run experiment based on the Dispense protocol.
 6. Visually assess the fluid level in the wells for accuracy. If the well volume appears to be unevenly distributed, clean the internal dispense tubes and injector heads as described in **Cleaning the Internal Components** starting on page 146.

Empty/ Clean the Tip Priming Trough

Applies only to models with injectors.

The tip priming trough is a removable cup located in the left rear of the microplate carrier, used for performing the Tip Prime. The trough holds approximately 1.5 mL of liquid and must be periodically emptied and cleaned by the user. Gen5 will instruct you to do this at the start of an experiment that requires dispensing.

1. Extend the microplate carrier and carefully remove the tip priming trough from its pocket in the left rear of the carrier.
2. Wash the trough in hot, soapy water. Use a small brush to clean in the corners.
3. Rinse the trough thoroughly and allow it to dry completely.
4. Replace the trough in the microplate carrier.

Clean the Priming Plate

Applies only to models with injectors.

Clean the priming plate regularly to prevent bacteria growth and residue buildup. Wash the plate in hot soapy water, using a small brush to clean in the corners. Rinse thoroughly and allow it to dry completely.

Clean the Internal Components

Applies only to models with injectors.



For models without injectors, the internal chamber and probes are not customer-accessible. Contact BioTek's Technical Assistance Center with any questions about your particular model.

The reader's internal dispense tubes and injector heads require routine cleaning at least quarterly and possibly more frequently depending on the type of fluids dispensed.

Cleaning inside the reader is required when fluid has spilled inside the instrument and/or if an unusually high background signal has been flagged by the assay controls.

Start with **Remove the Reader's Shroud** and execute the procedures that meet your needs, in the order in which they are presented. Finish with **Reassemble the Components**.



The buildup of deposits left by the evaporation of spilled fluids within the read chamber can impact performance of the fluorescence, luminescence, and absorbance functions. Perform a System Test before and after maintenance so that any changes in performance can be noted.



Wear protective gloves and safety glasses when performing the procedures.

Required Materials

- For all tasks, protective gloves and safety glasses
- For removing the shroud, Phillips screwdriver
- For cleaning the internal dispense tubes and injector heads, and for wiping the surface under the plate carrier:
 - Mild detergent or isopropyl alcohol
 - Clean, lint-free cotton cloths
 - Deionized or distilled water
 - Stylus (stored in a cylinder affixed to the back of the dispense module or reader; BioTek PN 2872304)

Remove the Reader's Shroud



Before removing the shroud, purge the dispense module (see page 143), and then turn off and disconnect the reader from its power supply, the PC, and the dispense module.

1. Purge the dispense module of fluid.
2. Disconnect power and all cables. Set the external dispense module aside.
3. Clear the work surface around the reader so you can easily access all sides of the instrument.
4. Remove two screws: one on each side of reader at the lower-rear corner.

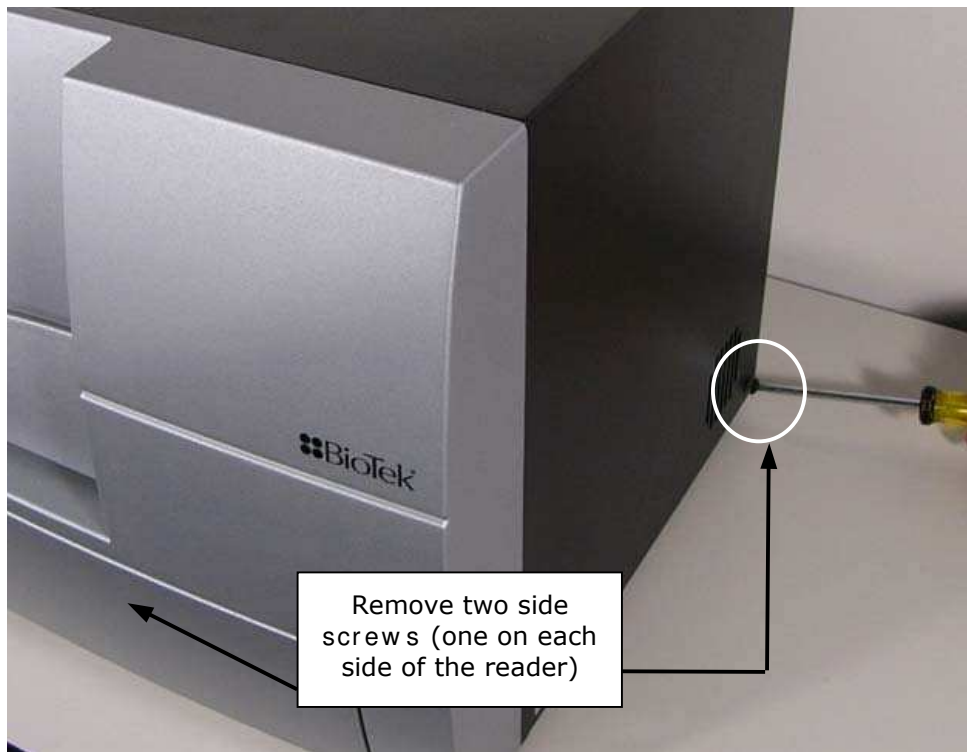

Figure 40: Screws in the lower-rear corners

5. Stand facing the front of the instrument. Grasp both sides of the shroud, slide it toward you, and pull it straight off the instrument. Set the shroud aside.



Figure 41: Removing the reader's shroud

❖ To reinstall the shroud, rest its bottom on the table in front of the reader and gently slide it into place. Internal wheels roll along the reader's bottom track to properly reposition the shroud.

Clean the shroud's air filters

If dust accumulates on the shroud's air filters:

- Use a vacuum cleaner to clean the filters in place, **or**
- Remove the grate holding the filters and soak the filters in mildly soapy water. Rinse well and reinstall.

Remove the Internal Dispense Tubes and Injector Heads

1. Locate the tubing ports on the reader's back wall. Turn each tube's thumbscrew counterclockwise and gently pull the tube from the port (**Figure 43**).
2. Locate the injector heads. Turn each tube's thumbscrew counterclockwise and gently pull the tube from its injector tip (**Figure 44**).
3. Turn each injector head counterclockwise and gently pull it out of the socket (**Figure 45**).

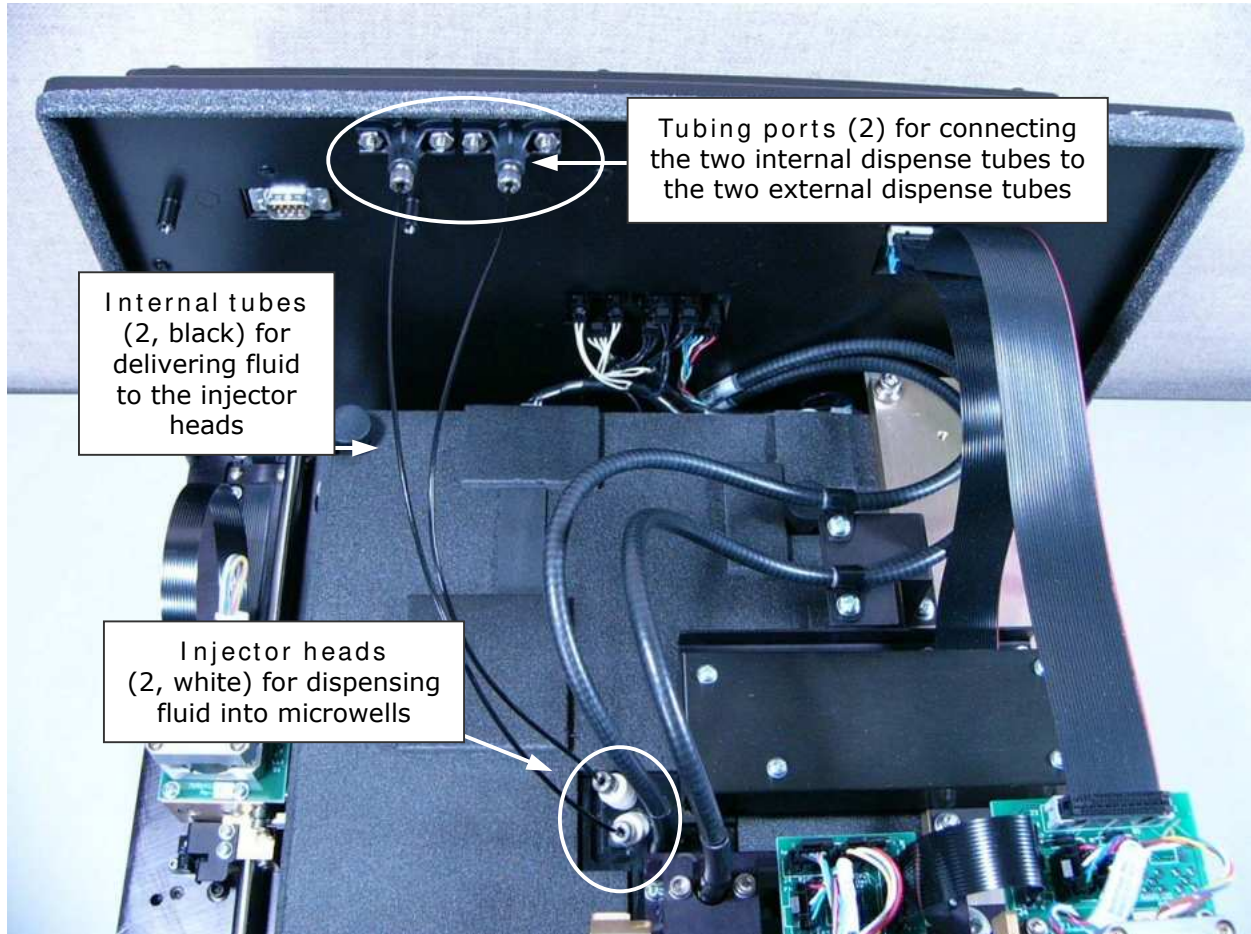

Figure 42: Internal components for the injector system



Figure 43: Disconnect the dispense tubes from the back wall

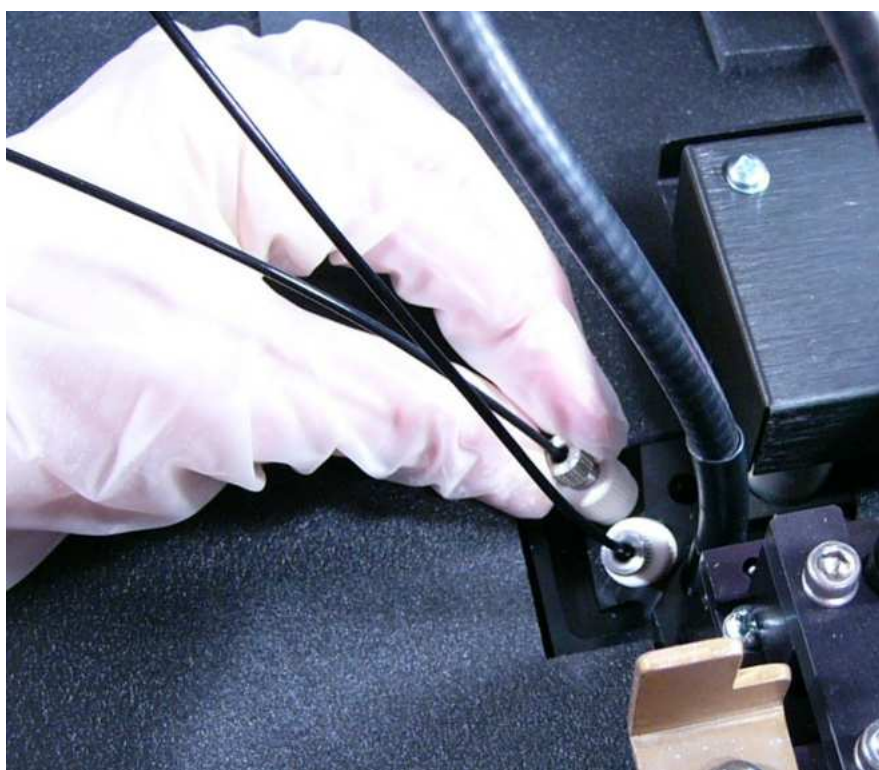

Figure 44: Disconnect the dispense tubes from the injector heads



Figure 45: Remove the injector heads

Clean the Dispense Tubes and Injector Heads

As discussed on page 138, some reagents can crystallize and clog the tubing and injector heads.

Daily flushing and purging can help to prevent this, but more rigorous cleaning may be necessary if reagent has been allowed to dry in the tubing and/or injectors.



Figure 46: Injector heads and internal dispense tubes

To clean the internal tubes, soak them in hot, soapy water to soften and dissolve any hardened particles. Flush each tube by holding it vertically under a stream of water.

To clean the injector tips:

- Gently insert the stylus into each injector tip to clear any blockages. The stylus (BioTek PN 2872304) is stored in a cylinder affixed to the back of the dispense module or reader.
- Stream water through the pipe to be sure it is clean. If the water does not stream out, try soaking in hot, soapy water and then reinserting the stylus.

- ❖ Do not bend the injector tips. A bent tip might not dispense accurately.
- ❖ Do not remove the o-rings (if equipped).

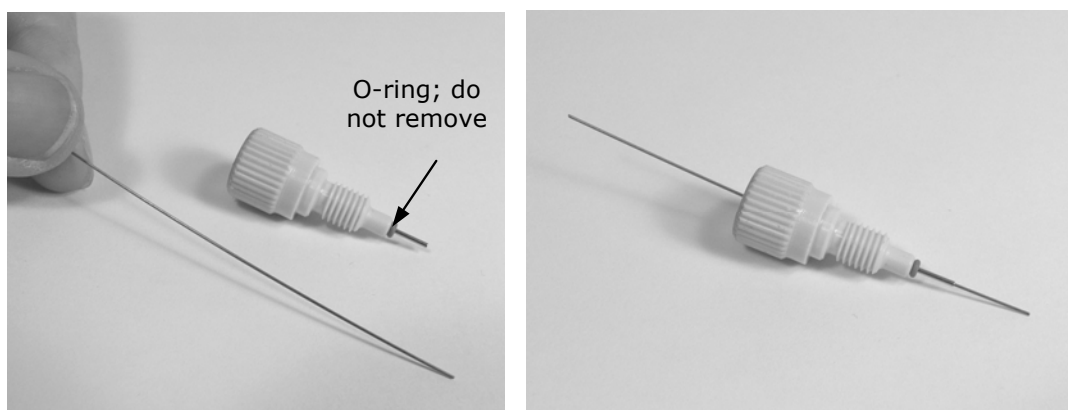

Figure 47: Injector head and stylus

Clean Inside the Reader

The internal surface and some components should be cleaned if reagent has spilled or if an unusually high background signal has been identified.

- BioTek recommends performing this process in conjunction with the previously defined steps for cleaning the dispense tubes and injectors.
- For this procedure you will need:
 - Deionized or distilled water and mild detergent (optional)
 - Two or more lint-free cotton cloths

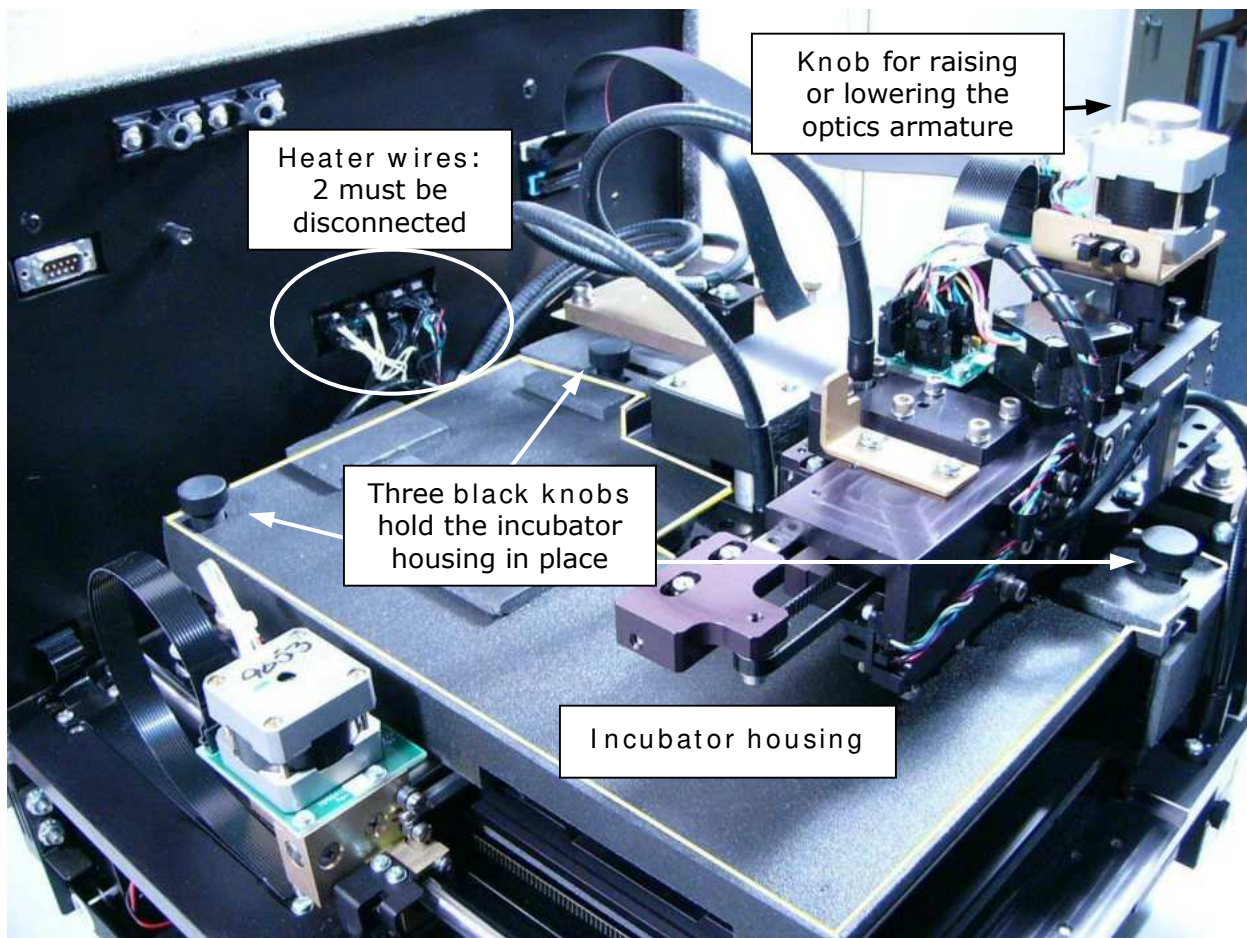

Figure 48: Internal components discussed in this section

Remove the Incubator Housing

1. If you have not already done so, unplug the reader and remove its shroud (page 147).
2. Disconnect **two** heater wires located on the reader's back wall. The two wires are in positions 1 and 3 of the top row (see below). To disconnect a wire, depress the tab and slide it off the board.

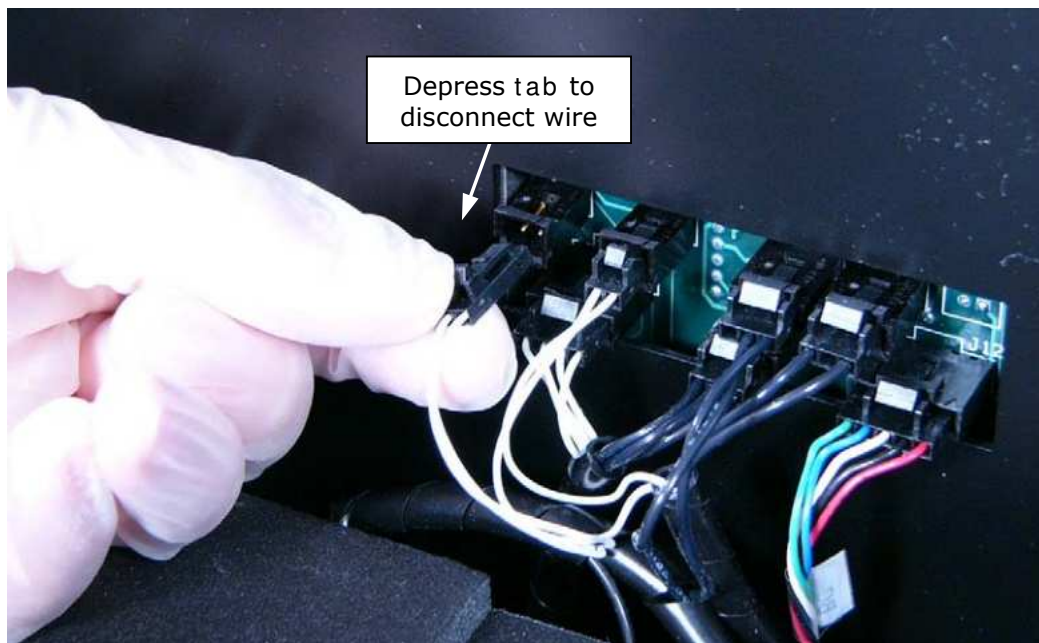
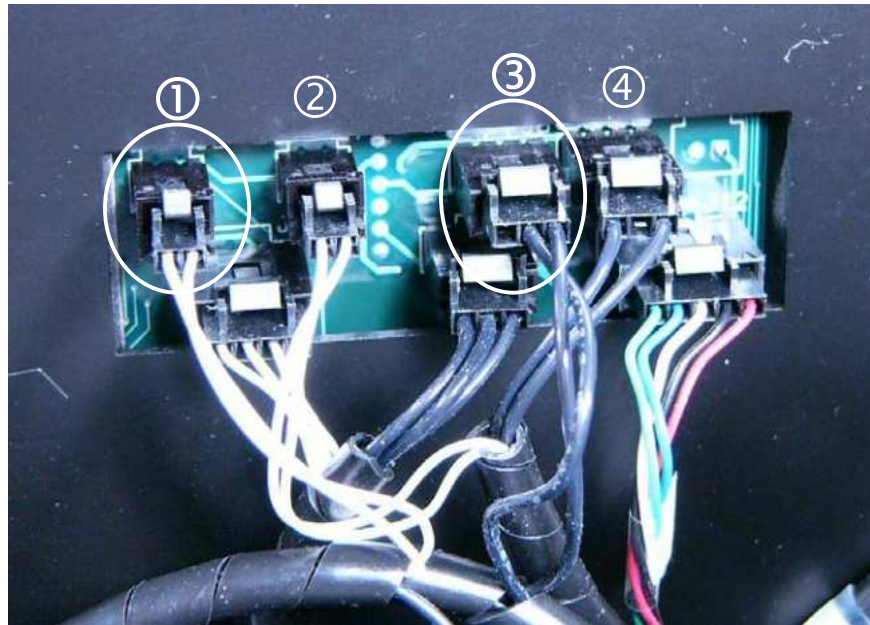

Figure 49: Disconnect heater wires 1 and 3 in the top row

3. Locate and remove the three knobs that secure the incubator housing.

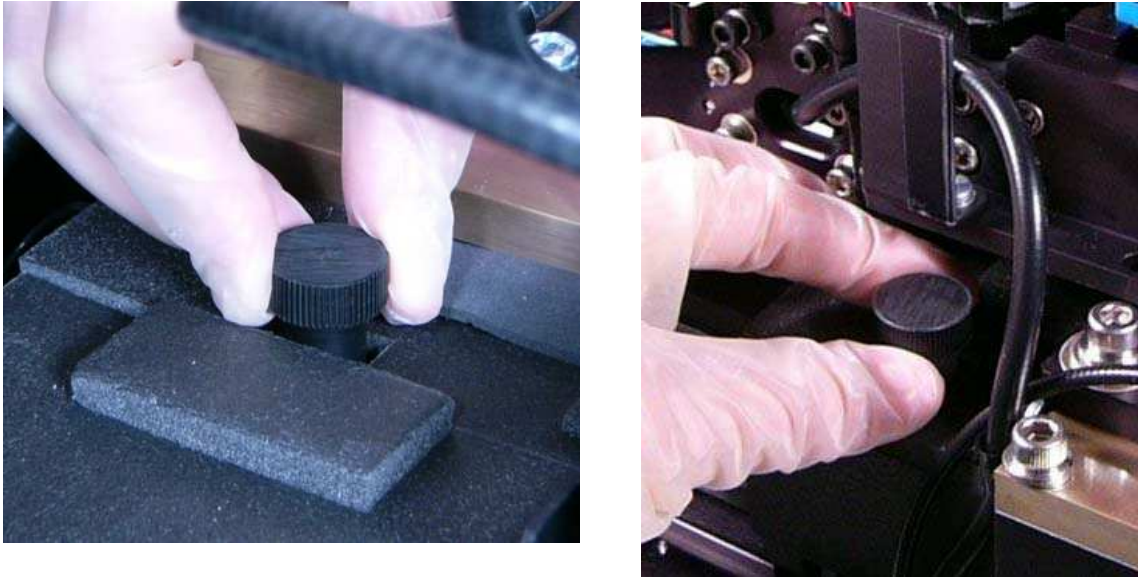

Figure 50: Removing the knobs that secure the incubator housing

4. Turn the optic arm knob clockwise to raise the optics armature as high as it will go.

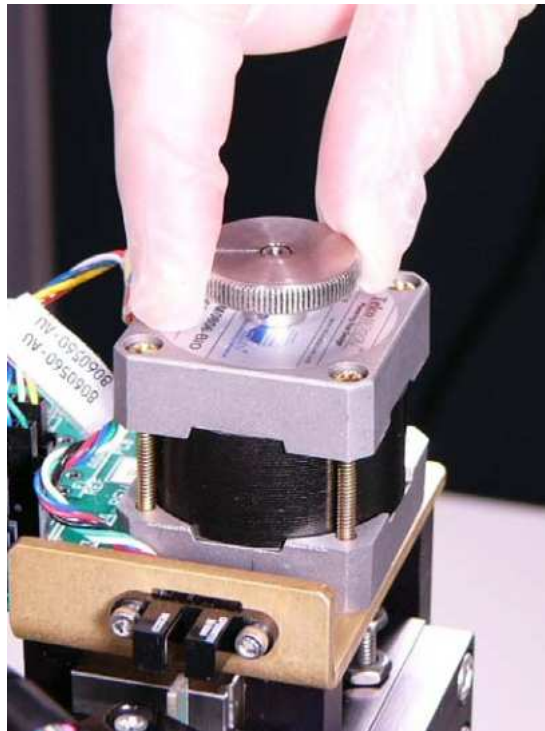

Figure 51: Raising the optics armature

5. Lift the left side of the incubator housing and carefully slide it out.
6. Turn over the incubator housing and clean the surface with water and mild detergent. Set it aside and let it dry completely.

❖ When replacing the incubator housing, the two “forks” on its right side should wrap around the holding screws. The forks should not slide under the fixed foam.

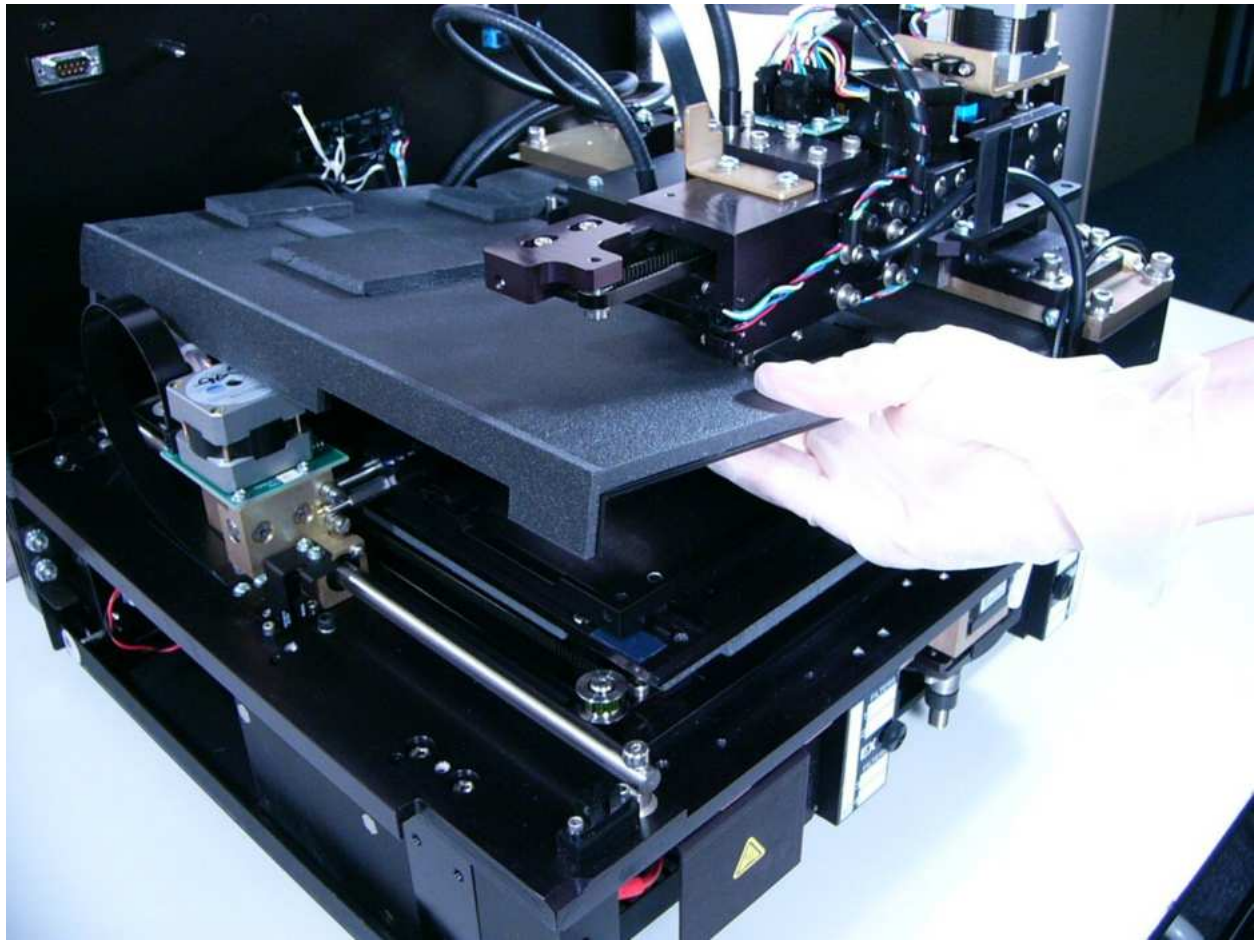

Figure 52: Removing the incubator housing

Clean the Reader's Surface

1. After you remove the incubator housing, slide the microplate carrier to the left to engage the support pin and then toward the front of the reader.

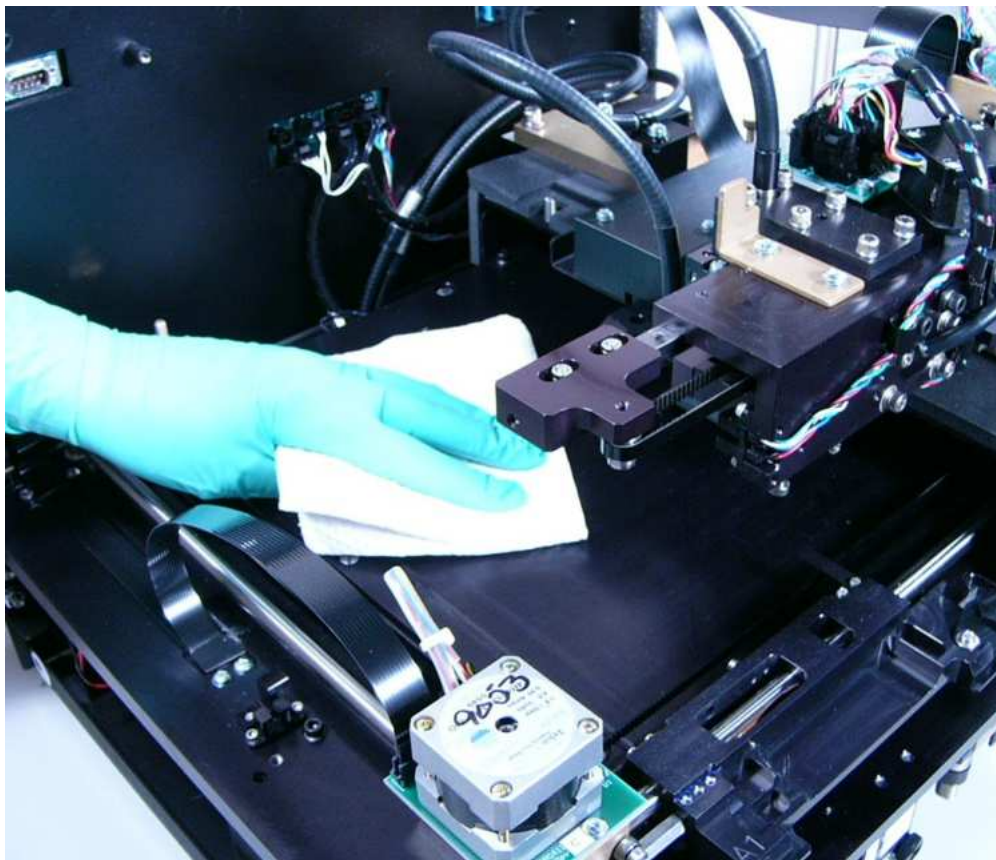
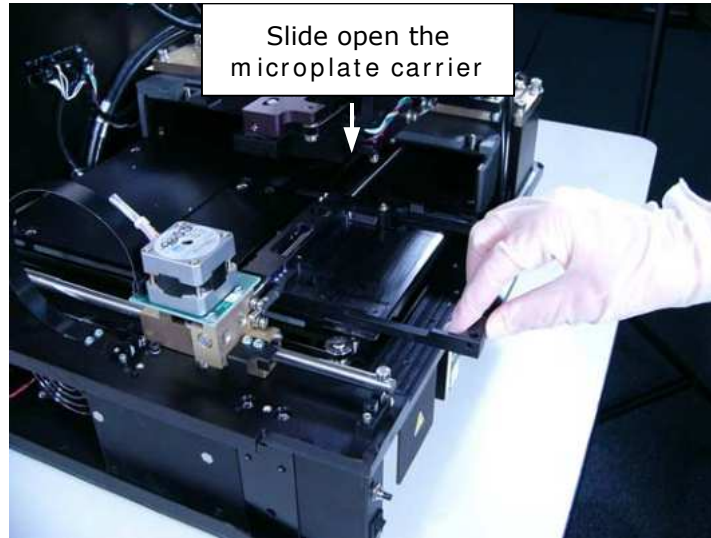

Figure 53: Cleaning the inside of the reader

2. Moisten (do not soak) a clean cotton cloth with water, or with water and mild detergent, or alcohol. Wipe all sides of the plate carrier. Wipe the instrument's horizontal surface.

If the injector heads were removed from the reader, use the cloth to gently clean the underside of the optical armature around the injector head holders.

❖ Do not apply pressure. Components are easily damaged.

3. If detergent was used, wipe the surfaces with a cloth moistened with water.
4. Use a clean, dry, lint-free cloth to dry all wet surfaces.

Reassemble the Components

1. Slide the microplate carrier all the way into the instrument.
2. If the incubator housing was removed, reinstall it.
 - Observe the two forks on the right side of the housing; they must wrap around the screws on either side of the optics armature. Do not slide the forks under the foam.



Figure 54: Incubator housing "fork" in the correct position

- Secure the incubator housing with the three knobs (**Figure 50**).
- Reconnect the two heater wires to the rear wall of the reader: the white wire fits into position 1 (**Figure 49**) in the top row of wires; the black wire fits into position 3.

3. Insert the two injector heads into their sockets. Ensure that they are properly seated; the knurled plastic should sit flush against the surface, as shown below.



Figure 55: Injector head properly seated

4. Attach the two internal dispense tubes to the injector heads (**Figure 44**). Do not overtighten the thumbscrews!
5. Attach the other end of the two dispense tubes to the tubing ports on the rear wall of the reader. They can go into either port.
6. Review the steps you just performed to make sure the components have been properly reassembled.
7. Slide the shroud onto the instrument, page 147.
8. Replace the two side screws to secure the shroud to the base.

Verify Performance

After reassembling the instrument, verify that the instrument is functioning properly:

- Connect power to the reader and turn it on. Allow the startup system test to complete. Run a System Test using Gen5; all tests should pass.
- Run any required OQ/PQ tests.

Chapter 7

As Needed Maintenance

This chapter contains maintenance and component-replacement procedures that need to be performed only occasionally.



Decontamination	162
Procedure for Models without Injectors	164
Procedure for Models with Injectors.....	165
Replace the Tungsten Lamp	169
Replace a Syringe	171

Decontamination

Any laboratory instrument that has been used for research or clinical analysis is considered a biohazard and requires decontamination prior to handling.

Decontamination minimizes the risk to all who come into contact with the instrument during shipping, handling, and servicing. Decontamination is required by the U.S. Department of Transportation regulations.

Persons performing the decontamination process must be familiar with the basic setup and operation of the instrument.

	<p>BioTek Instruments, Inc., recommends the use of the following decontamination solutions and methods based on our knowledge of the instrument and recommendations of the Centers for Disease Control and Prevention (CDC). Neither BioTek nor the CDC assumes any liability for the adequacy of these solutions and methods. Each laboratory must ensure that decontamination procedures are adequate for the biohazard(s) they handle.</p>
	<p>Wear prophylactic gloves when handling contaminated instruments. Gloved hands should be considered contaminated at all times; keep gloved hands away from eyes, mouth, and nose. Eating and drinking while decontaminating instruments is not advised.</p>
	<p>Mucous membranes are considered prime entry routes for infectious agents. Wear eye protection and a surgical mask when there is a possibility of aerosol contamination. Intact skin is generally considered an effective barrier against infectious organisms; however, small abrasions and cuts may not always be visible. Wear protective gloves when performing the decontamination procedure.</p>

Required Materials

For all models:

- Sodium hypochlorite (NaClO, or bleach)
- 70% isopropyl alcohol (as an alternative to bleach)
- Deionized or distilled water
- Safety glasses
- Surgical mask
- Protective gloves
- Lab coat
- Biohazard trash bags
- 125 mL beakers
- Clean, lint-free cotton cloths

Additional materials for models with injectors:

- Phillips screwdriver
- Small brush
- (Optional) Mild detergent

Procedure for Models without Injectors



The sodium hypochlorite (bleach) solution is caustic; wear gloves and eye protection when handling the solution.

Turn off and unplug the instrument for all decontamination and cleaning procedures.

Do not immerse the instrument, spray it with liquid, or use a “wet” cloth. Do not allow the cleaning solution to run into the interior of the instrument. If this happens, contact the BioTek Service Department.

1. Turn off and unplug the instrument.
2. Prepare an aqueous solution of 0.5% sodium hypochlorite (bleach). If the effects of bleach are a concern, 70% isopropyl alcohol may be used.

❖ Check the percent NaClO of the bleach you are using. Commercial bleach is typically 10.0% NaClO; prepare a 1:20 dilution. Household bleach is typically 5.0% NaClO; prepare a 1:10 dilution.

3. Moisten a cloth with the bleach solution or alcohol. Do not soak the cloth.
4. Open the plate carrier access door and slide out the carrier.
5. Wipe the plate carrier and all exposed surfaces of the instrument.
6. Wait 20 minutes. Moisten a cloth with deionized (DI) or distilled water and wipe all surfaces of the instrument that have been cleaned with the bleach solution or alcohol.
7. Use a clean, dry cloth to dry all wet surfaces.
8. Reassemble the instrument as necessary.
9. Discard the used gloves and cloths using a Biohazard trash bag and an approved Biohazard container.

Procedure for Models with Injectors

- ❖ Perform the Routine Procedure when the reader is functioning normally. If you are unable to perform a prime due to a system failure, perform the Alternate Procedure described on page 167.

Routine Procedure



If disinfecting with sodium hypochlorite (bleach), be sure to flush repeatedly with deionized water to remove the bleach. After disinfecting with sodium hypochlorite, perform the rinse procedure provided on page 166.

If disinfecting with alcohol, do not immediately prime with deionized water, because the drying effect of the alcohol is an important aspect of its disinfectant properties.

Clean Exposed Surfaces

1. Turn off and unplug the instrument.
2. Prepare an aqueous solution of 0.5% sodium hypochlorite (bleach). If the effects of bleach are a concern, 70% isopropyl alcohol may be used.
 - ❖ Check the percent NaClO of the bleach you are using. Commercial bleach is typically 10.0% NaClO; prepare a 1:20 dilution. Household bleach is typically 5.0% NaClO; prepare a 1:10 dilution.
3. Open the plate carrier access door and slide out the carrier.
4. Moisten a cloth with the bleach solution or alcohol. Do not soak the cloth.
5. Wipe the plate carrier and the exposed surfaces of the external dispense module.
6. Wait 20 minutes. Moisten a cloth with deionized (DI) or distilled water and wipe all surfaces that have been cleaned with the bleach solution or alcohol.
7. Use a clean, dry cloth to dry all wet surfaces.
8. Reassemble the instrument as necessary.
9. If the dispense module is installed, purge any fluid (see **Flush/Purge the Fluid Path** in Chapter 6) and detach the outlet tubes from the back of the instrument. If it is not installed, attach only the dispense module's communication cable to the instrument. Remove the supply bottles and their holders.
10. Perform the decontamination procedures described below.

Decontaminate the Fluid Lines

1. Place a beaker with 20 mL of 0.5% sodium hypochlorite solution or 70% isopropyl alcohol near SYRINGE 1 on the dispense module.
2. Place the SYRINGE 1 inlet tube in the beaker.
3. If you have not already done so, detach the dispense module's outlet tubes from the instrument's rear panel. Place the ends of the outlet tubes in an empty beaker and set the beaker next to the dispense module.
4. Launch Gen5, select System > Reader Control, and click the Dispenser tab.
5. Select Dispenser 1, enter a Volume of 5000 μL , and keep the default dispense Rate.
6. Place the priming plate on the carrier.
7. Run two prime cycles, for a total of 10,000 μL .
8. Wait at least 20 minutes to allow the solution to disinfect the tubing.
9. Remove the inlet tube from the beaker of disinfectant solution.
10. From the Reader Control dialog, change the Volume to 1000 μL .
11. Run one prime cycle, to flush the disinfectant out of the fluid lines.
12. Empty the beaker containing the outlet tubes. Put the tubes back in the empty beaker.
13. If sodium hypochlorite (bleach) was used, perform **Rinse the Fluid Lines** below. Otherwise, (or after performing the Rinse procedure), repeat steps 1-13 for SYRINGE 2/Dispenser 2.

Rinse the Fluid Lines

❖ Perform this procedure only if decontamination was performed using sodium hypochlorite.

1. Place a beaker containing at least 30 mL of deionized water on the dispense module.
2. Place the SYRINGE 1 or 2 inlet tube in the beaker.
3. If you have not already done so, place the outlet tubes in an empty beaker.
4. From the Reader Control dialog, select Dispenser 1 or 2, set the Volume to 5000 μL , and keep the default dispense Rate.
5. Run five prime cycles, for a total of 25,000 μL .
6. Pause for 10 minutes and then run one prime cycle with 5000 μL . This will allow any residual sodium hypochlorite to diffuse into the solution and be flushed out with the next prime.

7. Empty the beaker containing the outlet tubes.
8. Wipe all surfaces with deionized water.
9. Discard the used gloves and cloths using a biohazard trash bag and an approved biohazard container.

Clean the Internal Tubing and Injectors

Perform the procedures under “Clean the Internal Components” in **Chapter 6, Preventive Maintenance**.

Decontaminate the Tip Priming Trough and Priming Plate

1. Remove the tip priming trough from the instrument’s microplate carrier.
2. Wash the tip priming trough and priming plate in hot, soapy water. Use a small brush or cloth to clean the corners of the trough and plate.
3. To decontaminate, soak the trough and plate in a container of 0.5% sodium hypochlorite or 70% isopropyl alcohol for at least 20 minutes.
 - If decontaminating in a bleach solution, thoroughly rinse the trough and plate with DI water.
 - If decontaminating with alcohol, let the trough and plate air dry.
4. Discard the used gloves and cloths using a biohazard trash bag and an approved biohazard container.

Alternate Procedure

If you are unable to prime the reader due to a system failure, decontaminate the instrument and the dispense module as follows:

1. Perform the procedures under “Clean the Internal Components” in **Chapter 6, Preventive Maintenance**. When finished, leave the shroud off the reader and proceed to step 2.
2. Prepare an aqueous solution of 0.5% sodium hypochlorite (bleach). If the effects of bleach are a concern, 70% isopropyl alcohol may be used.

❖ Check the percent NaClO of the bleach you are using. Commercial bleach is typically 10.0% NaClO; prepare a 1:20 dilution. Household bleach is typically 5.0% NaClO; prepare a 1:10 dilution.



3. Slide the microplate carrier out of the instrument.
4. Moisten a cloth with the bleach solution or alcohol. Do not soak the cloth.
5. Use the cloth to wipe:
 - All surfaces of the shroud
 - All surfaces of the plate carrier

- The instrument's rear panel
 - The exposed surfaces of the dispense module, including the syringe valves
6. Remove the external tubing and the syringes from the dispense module and soak them in the bleach or alcohol solution. Wait for 20 minutes.
 7. Moisten a cloth with DI or distilled water and wipe all surfaces that have been cleaned with the bleach solution or alcohol.
 8. Rinse all tubing and the syringes with DI water.
 9. Use a clean, dry cloth to dry all surfaces on the instrument and the dispense module.
 10. Reassemble the instrument and dispense module as necessary.
 11. Discard the used gloves and cloths using a biohazard trash bag and an approved biohazard container.

Replace the Tungsten Lamp

The tungsten bulb is expected to operate without replacement for a minimum of 1000 hours. The intensity of the bulb will slowly drop over time until the reader's System Test detects a low signal and displays an error message. In addition, error code 2901 may be displayed during normal operation. The lamp should be replaced at this time; contact BioTek and order **part number 7080500**.

When the reader's front panel is opened, the tungsten lamp is located behind a light-blocking panel with the hot surface warning label. The lamp is secured by a bracket that also holds a condenser lens and a heat absorber. Two cables extend from the back of the lamp to plug into the reader.

	<p>The lamp is hot when the instrument is on. Before replacing the lamp, turn off the reader and allow the lamp to cool for at least 15 minutes.</p>
	<p>Do not touch the glass lenses! Fingerprints on the condenser lens or heat absorber may negatively affect performance.</p>

1. Turn off and unplug the reader. Wait at least 15 minutes for the lamp to cool.
2. Remove the reader's shroud (see page 147).
3. Remove the EX filter wheel and set aside.
4. Grasp the light-blocking panel and slide the assembly toward you, out of the reader.

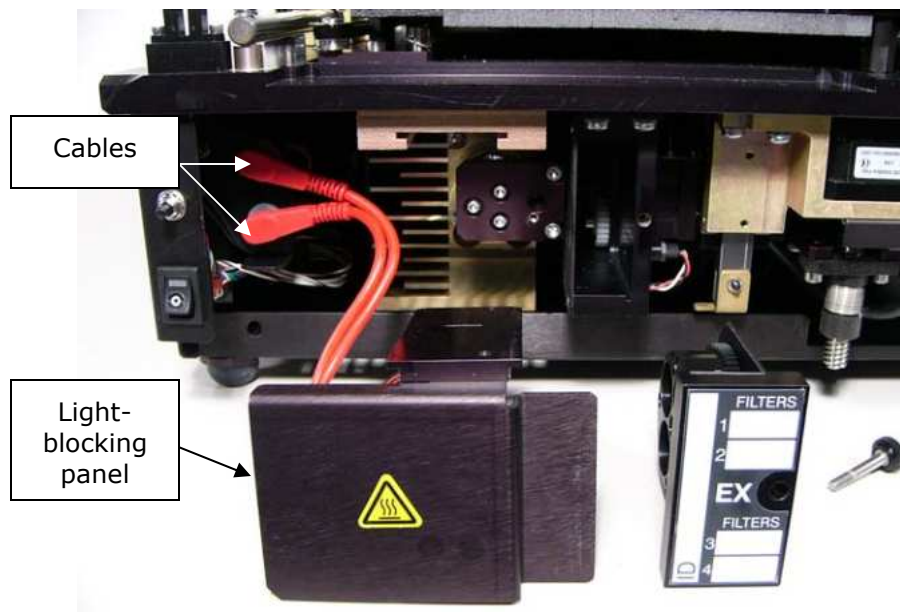

Figure 56: Light panel and EX wheel removed for lamp replacement

5. Unplug the lamp's cables from the reader.
6. Gently, without touching any glass components, unscrew one of the thumbscrews holding the bulb in its wire bracket.
7. When the bracket is free, remove the old bulb.

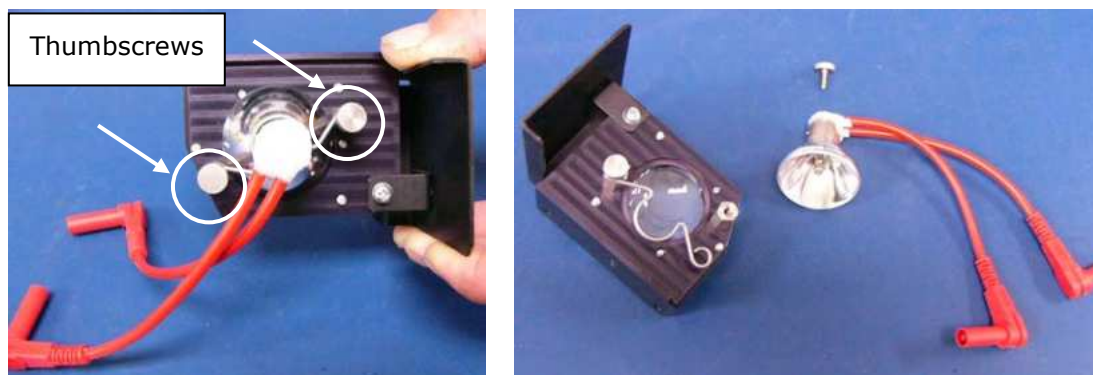

Figure 57: Lamp replacement

8. Insert the new bulb, position the wire bracket, and tighten the thumbscrew.
9. Align the lamp assembly with the reader, preparing to slide its top metal plate into its slot, and plug in the red cables. The cables can go into either plug.
10. Slide the lamp assembly into place without touching any other internal component. You may need to move the cables slightly downward to make room for the lamp.
11. Reinstall the EX filter wheel and the reader's shroud.
12. Plug in and turn on the reader. If the system test passes the lamp replacement was successful. Otherwise, note any errors and consult **Appendix B, Error Codes**.

Replace a Syringe

Refer to **Chapter 6, Preventive Maintenance** for cleaning procedures you should perform regularly and also in the case of poor performance. If cleaning the dispense module does not eliminate performance problems, or if a syringe is leaking, perform this procedure to replace a faulty syringe. Contact BioTek to order replacement syringes.

1. In Gen5, select System > Reader Control > Synergy 2 (Com < # >) and click the Dispenser tab.
2. Select the appropriate Dispenser number (1 or 2) associated with the syringe and click Maintenance. The syringe will move to its furthest-from-home position.
3. Using your fingers, remove the bottom thumbscrew that secures the syringe, underneath the bracket.
4. Turn the top thumbscrew to disengage the syringe from the valve.
5. Remove the new syringe from its protective box. (The syringe should be assembled in one piece; if not, see "Install the Dispense Module" in **Chapter 2, Installation**.)
6. Hold the syringe vertically with the threaded end at the top. Screw the top of the syringe into the bottom of the syringe valve. Finger-tighten only.
7. Pull down the bottom of the syringe until it rests inside the hole in the bracket.
8. Pass a thumbscrew up through the hole and thread it into the bottom of the syringe. Hold the syringe from rotating while tightening the screw. Finger-tighten only.
9. In Gen5, select System > Reader Control > Synergy 2 (Com < # >). Click the Dispenser tab and click Initialize.

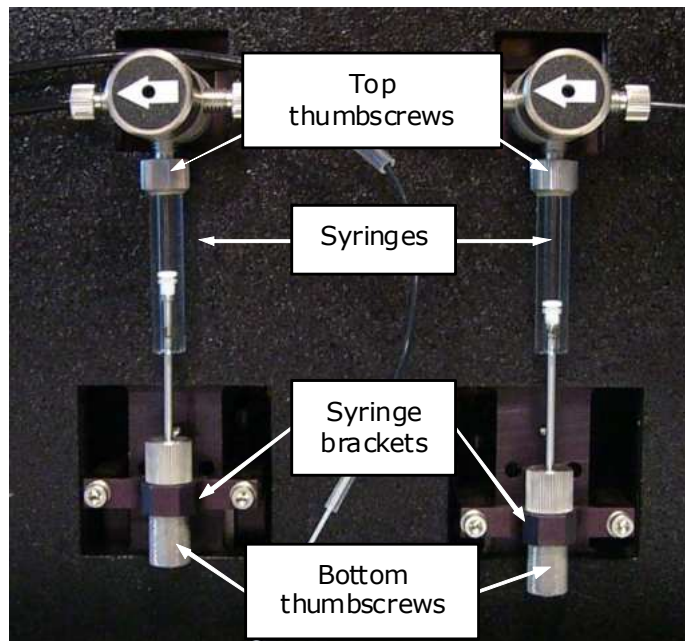

Figure 58: Dispense module syringes

Appendix A

Specifications

This chapter contains BioTek's published specifications for the Synergy 2.

General Specifications	174
Absorbance Specifications	175
Luminescence Specifications.....	176
Fluorescence Specifications	176
Models with Injectors	179

General Specifications

Microplates	
<p>The Synergy 2 accommodates standard 6-, 12-, 24-, 48-, 96-, 384-, and 1536-well microplates with 128 x 86 mm geometry, and the BioTek Take3 Multi-Volume Plate. Note: 1536-well microplates are not supported for luminescence measurements.</p>	
<p>Maximum Plate Height:</p>	
<p>Absorbance mode: plates up to 0.8" (20.30 mm) high</p>	
<p>Fluorescence/Luminescence modes: plates up to 1.25" (31.75 mm) high</p>	
<p>PCR tube trays up to 1.25" (31.75 mm) high (may require an adapter)</p>	
<p>Injector models dispense to standard height 6-, 12-, 24-, 48-, and 96-well microplates.</p>	

Hardware & Environmental	
Light Source:	<p>Absorbance: Xenon flash light source, 10W maximum average power, lamp life 1 billion flashes (not user-changeable)</p> <p>Fluorescence: Tungsten quartz halogen, 20W power, lamp life 1000 hours (user-changeable)</p> <p>TRF (and optionally for FI and FP): Xenon flash light source, 60W maximum average power, lamp life 1 billion flashes (not user-changeable)</p>
Dimensions:	<p>17.5" D x 15" W x 17.5" H</p> <p>44.5 cm D x 38.5 cm W x 44.5 cm H</p>
Weight:	With all modules installed, without power supply or dispense module attached, approx. 57 lbs. (25.8 kg)
Environment:	Operational temperature 18° to 40°C
Humidity:	10% to 85% relative humidity (non-condensing)
Power Supply:	24-volt external power supply compatible with 100-240 V~; +10% @50-60 Hz
Power Consumption:	250W maximum
Incubation:	<p>Temperature control range from 4° over ambient to 50°C.</p> <p>Temperature variation \pm 0.50°C across the plate @ 37°C (250 μl per well with the plate sealed).</p>
Plate Shaking:	<p>Low, Medium, High and Variable shaking speeds.</p> <p>Shake time is programmable by the user.</p>

Absorbance Specifications

Accuracy, Linearity, Repeatability	
All qualifications were conducted using 96-/384-well, flat bottom microplates. For the performance described here, the Gain on the Optics Test should be below 10.0.	
Measurement Range:	0.000 to 4.000 OD
Accuracy: 0.000 to 2.000 OD $\pm 1.0\%$ ± 0.010 OD Normal/Rapid modes, 96-well plates 0.000 to 2.000 OD $\pm 2.0\%$ ± 0.010 OD Normal/Rapid modes, 384-well plates 2.000 to 2.500 OD $\pm 3.0\%$ ± 0.010 OD Normal/Rapid modes, 96-/384-well plates 2.500 to 3.000 OD $\pm 3.0\%$ ± 0.010 OD Normal mode, 96-well plates 0.000 to 1.000 OD $\pm 1.0\%$ ± 0.010 OD Sweep mode, 96-/384-well plates	
Linearity: 0.000 to 2.000 OD $\pm 1.0\%$ Normal/Rapid modes, 96-well plates 0.000 to 2.000 OD $\pm 2.0\%$ Normal/Rapid modes, 384-well plates 2.000 to 2.500 OD $\pm 3.0\%$ Normal/Rapid modes, 96-/384-well plates 2.500 to 3.000 OD $\pm 3.0\%$ Normal mode, 96-well plates 0.000 to 1.000 OD $\pm 1.0\%$ Sweep mode, 96-/384-well plates	
Repeatability: 0.000 to 2.000 OD $\pm 1.0\%$ ± 0.005 OD Normal/Rapid modes, 96-/384-well plates 2.000 to 2.500 OD $\pm 3.0\%$ ± 0.005 OD Normal/Rapid modes, 96-/384-well plates 2.500 to 3.000 OD $\pm 3.0\%$ ± 0.005 OD Normal mode, 96-/384-well plates 0.000 to 1.000 OD $\pm 2.0\%$ ± 0.010 OD Sweep mode, 96-/384-well plates	

Optics	
λ range:	200 to 999 nm
λ accuracy:	± 2 nm
λ repeatability:	± 0.2 nm
λ bandpass:	2.4 nm
Detector:	Photodiodes (2) Measurements are reference channel-corrected for light source fluctuation

Read Timing			
Endpoint read time is from plate start to plate stop. Kinetic read time is from A1 to A1 read positions.			
Endpoint 96-well plate		Single 630 nm	Dual 630/450 nm
	Normal 0 ms delay:	34 sec	53 sec
	Normal 100 ms delay: Sweep:	43 sec 22 sec	73 sec 35 sec
Endpoint 384-well plate		Single 630 nm	Dual 630/450 nm
	Normal 0 ms delay:	77 sec	143 sec
	Normal 100 ms delay: Sweep:	115 sec 32 sec	220 sec 56 sec
Endpoint 1536-well plate		Single 630 nm	Dual 630/450 nm
	Normal 0 ms delay:	231 sec	450 sec
	Normal 100 ms delay: Sweep:	385 sec 53 sec	757 sec 97 sec
Kinetic 96-well		Single 630 nm	
	Normal 0 ms delay:	21 sec	
	Normal 100 ms delay: Sweep:	31 sec 11 sec	
Kinetic 384-well		Single 630 nm	
	Normal 0 ms delay:	66 sec	
	Normal 100 ms delay: Sweep:	104 sec 22 sec	
Kinetic 1536-well		Single 630 nm	
	Normal 0 ms delay:	219 sec	
	Normal 100 ms delay: Sweep:	373 sec 42 sec	

Luminescence Specifications

50 amol/well flash ATP in a 96-well plate (low-noise #49984 PMT)

500 amol/well flash ATP in a 96-well plate (red-shifted #49721 PMT)

Fluorescence Specifications

Read Timing	
Because of the possible wide variations in setup, the following benchmark conditions are specified:	
Excitation Filter:	485/20 nm
Emission Filter:	528/20 nm
Samples per well:	10
Delay before sampling:	100 ms
Delay between samples:	1 ms
96-well read:	99 sec
384-well read:	339 sec
1536-well read:	1256 sec

Optical Probes
Bottom position: 1.5, 3, or 5 mm diameter probes can be installed Top position: 3 mm diameter fixed, with motor-driven moveable apertures to reduce the diameter to support different plate formats

Sensitivity	
The following specifications apply to 96-well read formats using the Tungsten bulb.	
5 mm optical probe Bottom reading	10 pg/mL solution of Sodium Fluorescein in PBS 40 reads per location averaged, 350 ms delay before read 150 µL per well signal-to-noise ratio greater than 2 Excitation 485/20, Emission 528/20 Hellma 96-well quartz plate or Greiner SensoPlate 62.5 ng/mL solution of Propidium Iodide in PBS 40 reads per location averaged, 350 ms delay before read 150 µL per well signal-to-noise ratio greater than 2 Excitation 485/20, Emission 645/40 Corning Costar 96-well plate with black sides, clear bottom
3 mm optical probe Bottom reading	20 pg/mL solution of Sodium Fluorescein in PBS 40 reads per location averaged, 350 ms delay before read 150 µL per well signal-to-noise ratio greater than 2 Excitation 485/20, Emission 528/20 Hellma 96-well quartz plate
3 mm optical probe Bottom reading	125 ng/mL solution of Propidium Iodide in PBS 40 reads per location averaged, 350 ms delay before read 150 µL per well signal-to-noise ratio greater than 2 Excitation 485/20, Emission 645/40 Corning Costar 96-well plate with black sides, clear bottom

Sensitivity	
The following specifications apply to 96-well read formats using the Tungsten bulb.	
1.5 mm optical probe Bottom reading	<p>40 pg/mL solution of Sodium Fluorescein in PBS 40 reads per location averaged, 350 ms delay before read 150 μL per well signal-to-noise ratio greater than 2 Excitation 485/20, Emission 528/20 Hellma 96-well quartz plate</p> <p>250 ng/mL solution of Propidium Iodide in PBS 40 reads per location averaged, 350 ms delay before read 150 μL per well signal-to-noise ratio greater than 2 Excitation 485/20, Emission 645/40 Corning Costar 96-well plate with black sides, clear bottom</p>
3 mm fixed optical probe with movable apertures, Top reading	<p>2 pg/mL solution of Sodium Fluorescein in PBS 40 reads per location averaged, 5 mm Z-axis offset, 350 ms delay before read 200 μL per well signal-to-noise ratio greater than 2 Excitation 485/20, Emission 528/20, Dichroic 510 nm Corning Costar 96-well solid black plate</p> <p>0.16 ng/mL solution of Methylumbelliferone in CBB 40 reads per location averaged, 5 mm Z-axis offset, 350 ms delay before read 150 μL per well signal-to-noise ratio greater than 2 Excitation 360/40, Emission 460/40, 50% mirror Corning Costar black strips</p>

Time-Resolved Fluorescence	
96/384-well plates:	250 fM Europium (plate and well modes), 20 reads per location, 5 mm Z-axis offset, 350 ms delay before read
Integration Interval:	20 to 16000 μ s
Delay:	0 to 16000 μ s
Granularity:	1- μ s steps

Fluorescence Polarization	
96/384-well plates:	5 mP at 1 nM Sodium Fluorescein, 60 reads per location, 5 mm Z-axis offset 350 ms delay before read

Models with Injectors

Dispense/ Read	
Specifications apply to models with the dual-reagent dispense module	
Plate Type:	Dispenses to standard 6-, 12-, 24-, 48-, and 96-well microplates with standard 128 x 86 mm geometry
Detection Method:	Absorbance, Fluorescence, Luminescence
Volume Range:	5-1000 μ L with a 5-20 μ L tip prime
Accuracy:	Dispensing deionized water with 0.1% Tween 20 at room temperature: \pm 1 μ L at 5-50 μ L \pm 2% at 51-1000 μ L
Precision:	Dispensing a 200 μ L solution of deionized water, 0.1% Tween 20, and dye at room temperature: < 2.0% for volumes of 50-200 μ L < 4.0% for volumes of 25-49 μ L < 7.0% for volumes of 10-24 μ L < 10.0% for volumes of 5-9 μ L

Appendix B

Error Codes

This chapter contains the most common and easily resolved Synergy 2 error codes that may appear in Gen5.

Overview	182
Error Codes	183

Overview

When a problem occurs during operation with the Synergy 2, an error code will appear in Gen5. Error codes typically contain four characters, such as “2B0A,” and in most cases are accompanied by descriptive text, such as “Priming plate not detected.” With many errors, the instrument will beep repeatedly; press the carrier eject button to stop this alarm.

Some problems can be solved easily, as with 2B0A (place a priming plate on the carrier). Some problems can be solved only by trained BioTek Service personnel. This appendix lists the most common and easily resolved error codes that you may encounter.

- ❖ Error codes beginning with “A” (e.g., A100) indicate conditions that require immediate attention. If this type of code appears, turn the instrument off and on. If the System Test does not conclude successfully, record the error code and contact BioTek’s Technical Assistance Center.

If an error code appears in Gen5, you may want to run a System Test for diagnostic purposes. In Gen5, select System > Diagnostics > Run System Test.



If an error message appears while an experiment is in process and after having received measurement data, it is your responsibility to determine if the data is valid.

Contact Info: BioTek Service/ TAC

Use this appendix to diagnose problems and solve them if possible. If you need further assistance, contact BioTek’s Technical Assistance Center.

Phone: 800-242-4685 (toll free in the U.S.)
802-655-4740 (outside the U.S.)

Fax: 802-654-0638

E-Mail: tac@biotek.com

- ❖ For errors that are displayed during operation of the reader with the BioStack Microplate Stacker, refer to the BioStack Operator’s Manual.

Error Codes

This table lists the most common and easily resolved error codes that you may encounter. If an error code appears in Gen5, look for it here. If you find the code, follow the suggestions provided for solving the problem. If you cannot find the code or if you are unable to solve the problem, please contact BioTek's Technical Assistance Center. The Gen5 Help system also provides troubleshooting tips.

Code	Description and Possible Remedies
0202 0203	<i>EX/EM filter wheel (respectively) did not home</i> Generally, this error indicates the Excitation or Emission filter wheel is not seated properly in the reader. Remove the wheel, ensure each filter or plug is properly positioned, and reinstall it securely. Restart the reader.
020B 020C	<i>Dispenser syringe 1 or 2 (respectively) did not home</i> Generally, this error indicates the syringe was not properly installed. Make sure the syringe's thumbscrews are properly threaded. (Refer to the Installation chapter for instructions.) Restart the reader.
0402 0403	<i>EX/EM filter wheel (respectively) failed positional verify</i> Generally, this error indicates the Excitation or Emission filter wheel is not seated properly in the reader. Remove the wheel, ensure each filter or plug is properly positioned, and reinstall it securely. Restart the reader.
040B 040C	<i>Dispenser syringe 1 or 2 failed position verify</i> Generally, this error indicates the syringe was not properly installed. Make sure the syringe's thumbscrews are properly threaded. (Refer to the Installation chapter for instructions.) Restart the reader.
050x	<i>Light beam saturated (too much light). Relative Fluorescing Units (RFU) reached (99999).</i> This error can indicate one of several scenarios. It is possibly due to incorrect chemistry, e.g., the fluorescence standards dispensed to the plate exceed expectations. See also the description for 0E01. Verify that the microplate carrier access door is closing properly and no ambient light is getting into the read chamber. If you are manually setting the Sensitivity values in your Gen5 procedure, try using the Automatic Sensitivity Adjustment feature. Verify that the Gen5 Fluorescence/Luminescence filter table matches the contents of the filter wheels. Verify that the EX filter in position #2 does not overlap with the EM filter in position #3. For models with injectors, the internal chamber may require cleaning (see Preventive Maintenance).

Code	Description and Possible Remedies
0700 0800 0900	<p><i>Noise Test Errors, Offset Test Errors, Dark Range Errors</i></p> <p>This series of System Test errors may indicate that there is too much light inside the chamber. Make sure the reader's shroud is properly fastened, and the plate carrier door and the front hinged door are properly closed.</p> <p>For models with injectors, if the dispense tubes are not connected to the back of the reader, re-install the plastic plugs that shipped with the instrument (or cover the holes with black tape). Restart the reader.</p>
0E01-6	<p><i>Fluorescence wavelength not found in table</i></p> <p>This error indicates that the specified wavelength is not detected in the reader's filter table. The last number is the filter set number in the assay protocol. In Gen5, verify the Fluorescence filter table has the wavelengths loaded into the reader. Compare the contents of the table with the Excitation and Emission filters installed (see the Gen5 Help system for more information). Restart the reader.</p>
0F01	<p><i>Filter is defined in the wrong location</i></p> <p>Ensure that Gen5's Fluor/Lum wavelengths table matches the actual filters installed in the filter wheels.</p>
1306-7 1406-7	<p><i><Motor> not homed successfully</i></p> <p>This error indicates that the <motor> is not at home.</p> <p>Make sure the Plate Type described in the Gen5 Protocol matches the plate you are using.</p> <p>Check for any obstructions that may prevent the carrier, syringes, or filter wheels from moving normally. Restart the reader.</p>
2901	<p><i>Tungsten Lamp reference voltage out of range</i></p> <p>A test of the tungsten lamp is performed when the instrument is turned on and then periodically during background functions. This error may indicate that the lamp is weak or defective. Refer to the As Needed Maintenance chapter for instructions to replace the lamp. If the error still appears after replacing the lamp, contact BioTek TAC.</p>
2A01	<p><i>Plate jam error</i></p> <p>Make sure the Plate Type described in the Gen5 Protocol matches the plate you are using. This error can also occur if the plate type is correct but the lid was left on the plate. If you wish to read the plate with a lid on it, create a new plate type in Gen5 and be sure to enter the correct Plate Height.</p> <p>Models with injectors: Verify that the tip prime trough and priming plate are not stuck in the reading chamber.</p>
2B01-04	<p><i>Syringe motor axis did not find the home opto sensor transition</i></p> <p>Generally, this error indicates the syringe was not properly installed. Make sure the syringe's thumbscrews are properly threaded. (Refer to the Installation chapter for instructions.) Restart the reader.</p>
2B0A	<p><i>Priming plate not detected</i></p> <p>Applies to models with injectors.</p>
3306	<p><i>Required carrier in when expected to be outside</i></p> <p>The carrier is inside the read chamber and the probe needs to move down for the requested operation. Press the Carrier Eject button and restart the experiment.</p>

Code	Description and Possible Remedies
4xxx	<p><i>PMT overload well error at <well # ></i></p> <p>This error typically means that the fluid in a well has oversaturated the PMT (i.e., the well is too "bright"). Try lowering the sensitivity value in the read step.</p> <p>Wells are counted starting at A1, moving left-to-right, row-by-row.</p> <p>The row and column of the well can be extracted from the well number code by applying the following formula (example uses 8 x 12 geometry, 96-well plate):</p> <ol style="list-style-type: none"> 1. Convert the ASCII hex string to a decimal equivalent. Ex: "057" indicates 57 hex, yielding a well code of 87 decimal. 2. Row = (well code) / (columns in plate), rounded up to a whole number. Ex: 87/12 = 7.25, indicating row 8 (or H). 3. Column = (well code) - ((row-1) * (columns in plate)). Ex: 87 - ((8 - 1) * 12) = column 3. <p>NOTE: If this code is returned during an area scan, it indicates the scan point corresponding to the row/column equivalent in the currently defined scan map, NOT the actual well where the error occurred.</p>

Appendix C

Instrument Dimensions for Robotic Interface

This section shows the location of the microplate carrier in reference to the exterior surfaces of the Synergy 2 and the mounting holes on the bottom. Use the illustrations to facilitate system setup with a robotic instrument, such as the BioStack Microplate Stacker. Dimensions are in inches.

❖ The Synergy 2 is 17.5" D x 15.0" W x 17.5" H (44.5 cm D x 38.5 cm W x 44.5 cm H).

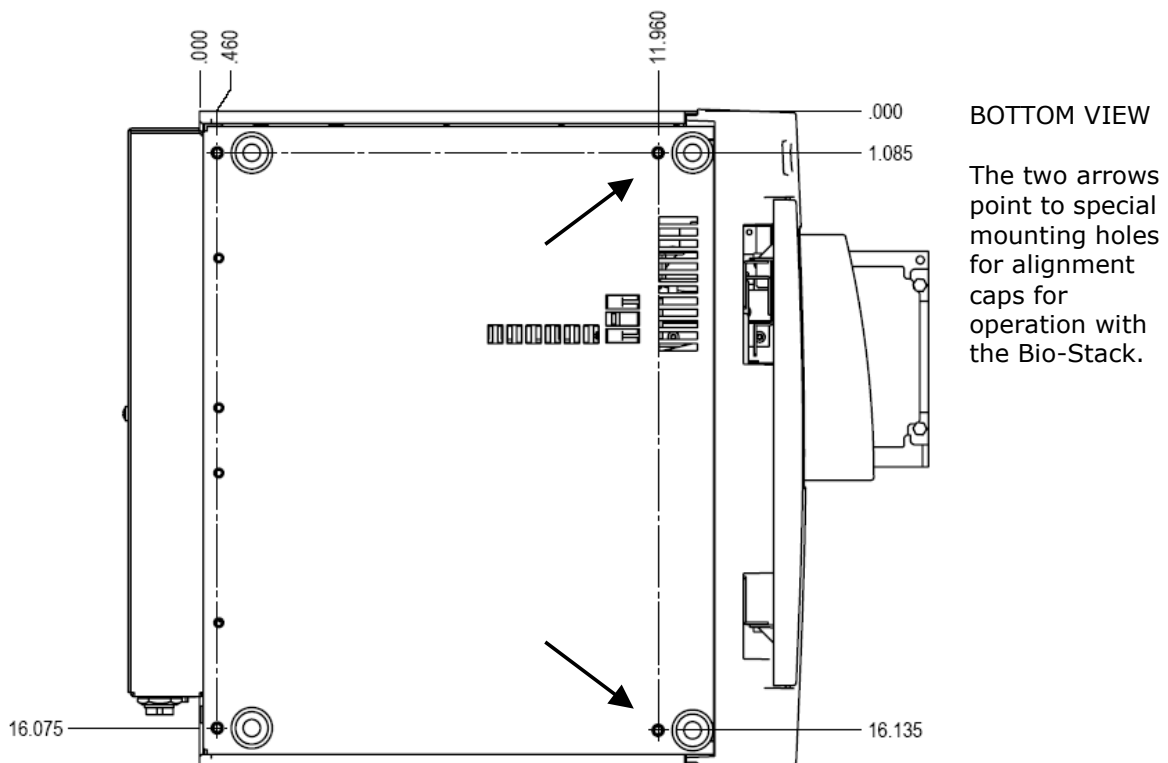

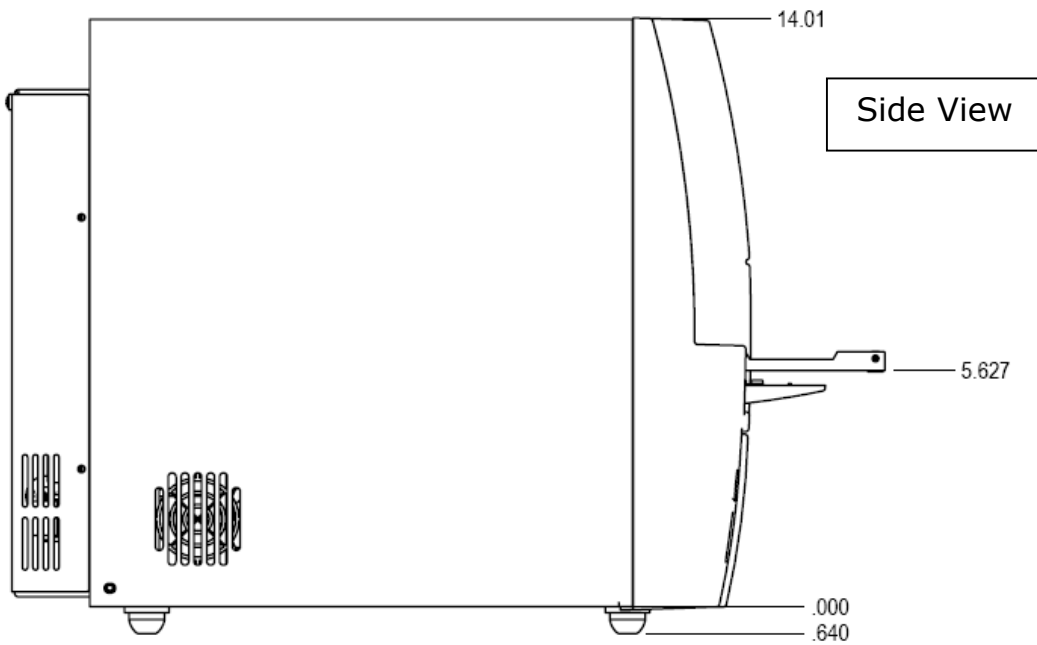
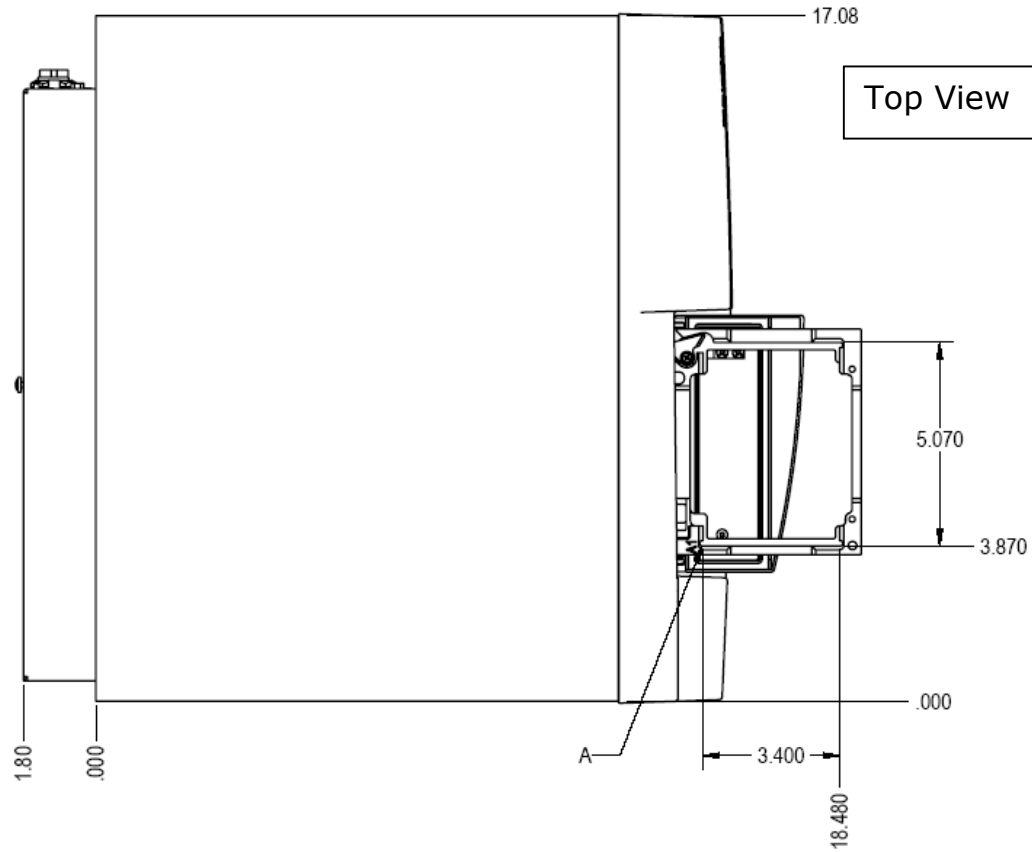

If you purchased the BioStack to operate with the Synergy 2, the BioStack alignment kit contains hardware for correct positioning. Refer to the Installation chapter in the **BioStack Operator's Manual**.