

GENESYS 10S UV-Vis

User Guide

269-251800 Revision A

October 2009



LAB Online Exhibition



© 2008-2009 Thermo Fisher Scientific Inc. All rights reserved.

Microsoft, Windows, Vista, Windows NT and Excel are either trademarks or registered trademarks of Microsoft Corporation in the United States and/or other countries. Clorox is either a trademark or registered trademark of The Clorox Company in the United States and/or other countries. Triton is either a trademark or registered trademark of Union Carbide in the United States and/or other countries. Pyrex is either a trademark or registered trademark of Corning Incorporated in the United States and/or other countries. All other trademarks are the property of Thermo Fisher Scientific Inc. and its subsidiaries.

For Technical Support, please contact:

Thermo Fisher Scientific
5225 Verona Road
Madison WI 53711-4495 U.S.A.
Telephone: 1 800 532 4752
E-mail: us.techsupport.analyze@thermofisher.com
World Wide Web: <http://www.thermo.com/spectroscopy>

For International Support, please contact:

Thermo Fisher Scientific
Telephone: +1 608 273 5017
E-mail: support.madison@thermofisher.com
World Wide Web: <http://www.thermo.com/spectroscopy>

Thermo Fisher Scientific Inc. provides this document to its customers with a product purchase to use in the product operation. This document is copyright protected and any reproduction of the whole or any part of this document is strictly prohibited, except with the written authorization of Thermo Fisher Scientific Inc.

The contents of this document are subject to change without notice. All technical information in this document is for reference purposes only. System configurations and specifications in this document supersede all previous information received by the purchaser.

Thermo Fisher Scientific Inc. makes no representations that this document is complete, accurate or error-free and assumes no responsibility and will not be liable for any errors, omissions, damage or loss that might result from any use of this document, even if the information in the document is followed properly.

This document is not part of any sales contract between Thermo Fisher Scientific Inc. and a purchaser. This document shall in no way govern or modify any Terms and Conditions of Sale, which Terms and Conditions of Sale shall govern all conflicting information between the two documents.

Release history:

Contents

| | | |
|------------------|--|------------|
| | Preface | vii |
| | Safety and Special Notices | vii |
| Chapter 1 | Spectrophotometer Basics | 1 |
| | Spectrophotometer Components | 1 |
| | Connectors | 1 |
| | About the Keypad | 3 |
| | Cell Holders | 4 |
| | 6-Position Cell Holder | 5 |
| | Single Cell Holder | 5 |
| | Selecting and Positioning Cuvettes | 5 |
| | Z-dimensions | 6 |
| Chapter 2 | Setting Up the Instrument | 7 |
| | Entering Parameter Values | 7 |
| | Numeric Entry | 7 |
| | Menu Selection | 8 |
| | On/Off Toggle | 8 |
| | Alphanumeric Entry | 8 |
| | Setting Utility Parameters | 9 |
| | Setting the Date and Time | 9 |
| | Standby Mode | 11 |
| | Setting Baseline Expiration Time | 11 |
| | Setting the Screen Contrast | 11 |
| | Setting Up the Internal Printer | 12 |
| | Setting the Utility Parameters for the Printer | 12 |
| Chapter 3 | Accessories | 15 |
| | Cell Holders and Cell Holder Accessories | 15 |
| | Cell Holder Configurations | 15 |
| | Cell Holder Initialization | 18 |
| | Changing Cell Holders | 18 |
| | Installing the 6-Position Cell Holder and the Single Cell Holder | 19 |
| | Removing the 6-Position Cell Holder and the Single Cell Holder | 20 |
| | Installing Accessory Cell Holders | 20 |

| | | |
|-------------------|--|-----------|
| | Installing the Internal Printer (Optional) | 21 |
| | Loading Paper in the Internal Printer | 22 |
| | External Printers | 23 |
| Chapter 4 | Sample Positioner Setting | 25 |
| | Auto 6 | 25 |
| | Auto 3 | 25 |
| | Single Cell Holder | 25 |
| | Manual 6 | 26 |
| Chapter 5 | Cell Correction | 27 |
| | Cell Correction | 27 |
| | Specifying Wavelengths for Discrete nms Mode | 29 |
| Chapter 6 | Managing Stored Tests | 31 |
| | Software Password | 31 |
| | Naming a Test | 31 |
| | Saving a Test | 32 |
| | Loading Test Files | 34 |
| | Lock/Unlock | 35 |
| | Deleting a Test | 35 |
| Chapter 7 | SmartStart | 37 |
| Chapter 8 | Concentration Units | 39 |
| | Specifying Concentration Units | 39 |
| | Creating Custom Units | 40 |
| Chapter 9 | Calculator Function | 41 |
| Chapter 10 | Abs and %T Measurements—Basic A-%T-C | 43 |
| | Setting the Wavelength | 43 |
| | Measuring a Blank | 44 |
| | Measuring Samples | 44 |
| Chapter 11 | Abs and %T Measurements—Advanced A-%T-C | 45 |
| | Recalling a Test | 45 |
| | Setting Up Test Parameters | 46 |
| | Taking Measurements | 46 |
| Chapter 12 | Basic Concentration Measurements—Basic A-%T-C | 49 |
| | Basic Concentration Measurements | 49 |
| | Setting the Wavelength and Mode | 50 |
| | Using Conc/Std to Measure Concentration | 50 |
| | Using Conc/Factor to Measure Concentration | 51 |
| | Measuring Samples | 52 |

| | | |
|-------------------|--|-----------|
| Chapter 13 | Concentration Measurements—Advanced A-%T-C | 53 |
| | Recalling a Test | 53 |
| | Setting Up Test Parameters | 54 |
| | Measuring a Standard | 54 |
| | Entering a Factor | 55 |
| | Measuring Samples | 55 |
| Chapter 14 | Scanning | 57 |
| | Recalling a Test | 57 |
| | Setting Up Test Parameters | 58 |
| | Collecting a Baseline Scan | 58 |
| | Scanning a Sample | 59 |
| | Viewing and Manipulating Scan Data | 60 |
| | Rescaling Graphical Scan Data | 60 |
| | Performing Calculations on the Scan Data | 62 |
| | Labeling Peaks and Valleys | 62 |
| | Smoothing Data | 63 |
| | Determining Peak Height Using a 3-point Net Equation | 63 |
| | Calculating the Area Under a Curve | 64 |
| | Viewing and Rescaling Tabular Scan Data | 65 |
| Chapter 15 | Multiwavelength | 67 |
| | Recalling a Test | 67 |
| | Setting Up Test Parameters | 68 |
| | Adding Wavelengths and Factors | 68 |
| | Deleting Wavelengths and Factors | 69 |
| | Taking Measurements | 69 |
| Chapter 16 | Absorbance Ratio | 71 |
| | Recalling a Test | 71 |
| | Setting Up Test Parameters | 72 |
| | Measuring Samples | 72 |
| Chapter 17 | Absorbance Difference | 75 |
| | Recalling a Test | 75 |
| | Using the Absorbance Ratio Screen | 76 |
| | Setting Up Test Parameters | 76 |
| | Measuring Samples | 77 |
| Chapter 18 | 3-Point Net | 79 |
| | Recalling a Test | 80 |
| | Setting Up Test Parameters | 80 |
| | Taking Measurements | 80 |

| | | |
|-------------------|--|------------|
| Chapter 19 | Concentration Measurements—Standard Curve Application | 83 |
| | Recalling a Standard Curve | 84 |
| | Setting the Parameters for a Standard Curve | 84 |
| | Measuring the Standards for a Standard Curve | 84 |
| | Using the Standards Screen | 86 |
| | Measuring Samples | 86 |
| | Editing a Standard Curve | 87 |
| Chapter 20 | Kinetics | 91 |
| | Recalling a Test | 92 |
| | Setting Up Test Parameters | 92 |
| | Measuring Samples | 93 |
| | Recalling and Recalculating Graphical Kinetics Results | 94 |
| | Rescaling and Recalculating Tabular Kinetics Results | 97 |
| Chapter 21 | Performance Verification | 99 |
| | Accessing the Performance Verification Tests | 99 |
| | Troubleshooting Checklist | 100 |
| | Wavelength Accuracy - Internal | 101 |
| | Wavelength Accuracy - Standard | 101 |
| | Wavelength Repeatability | 103 |
| | Resolution | 104 |
| | Photometric Accuracy | 104 |
| | Selecting the Mode | 105 |
| | Adding Standards | 105 |
| | Deleting Standards | 106 |
| | Running the Test | 106 |
| | Noise | 107 |
| | Stray Light | 108 |
| | Running the Test | 108 |
| | Internal Printer Test | 108 |
| Chapter 22 | Maintenance | 111 |
| | Routine Care | 111 |
| | Cleaning and Maintaining Cells | 112 |
| | Cleaning the Windows of the Sample Compartment | 114 |
| | Changing the Fuse | 114 |
| Chapter 23 | Parameters | 117 |
| Chapter 24 | Calculations for Software | 127 |
| Chapter 25 | Calculations for Oligo Calculator | 131 |

Preface

Congratulations on your purchase of a Thermo Scientific spectrophotometer! Our spectrophotometers integrate advanced hardware features with the power and flexibility of a wide range of accessories.

Safety and Special Notices

Make sure you follow the precautionary statements presented in this guide. The safety and other special notices appear in boxes.

Safety and special notices include the following:

Note Notes contain helpful supplementary information.

IMPORTANT Follow instructions labeled “Important” to avoid damaging the system hardware or losing data.

CAUTION Indicates a hazardous situation which, if not avoided, could result in minor or moderate injury.

WARNING Indicates a hazardous situation which, if not avoided, could result in death or serious injury.

Spectrophotometer Basics

This chapter describes:

- Spectrophotometer Components
- Cell Holders
- Selecting and Positioning Cuvettes
- Z-dimensions

Spectrophotometer Components

Here are some major components visible on the outside of a typical instrument:

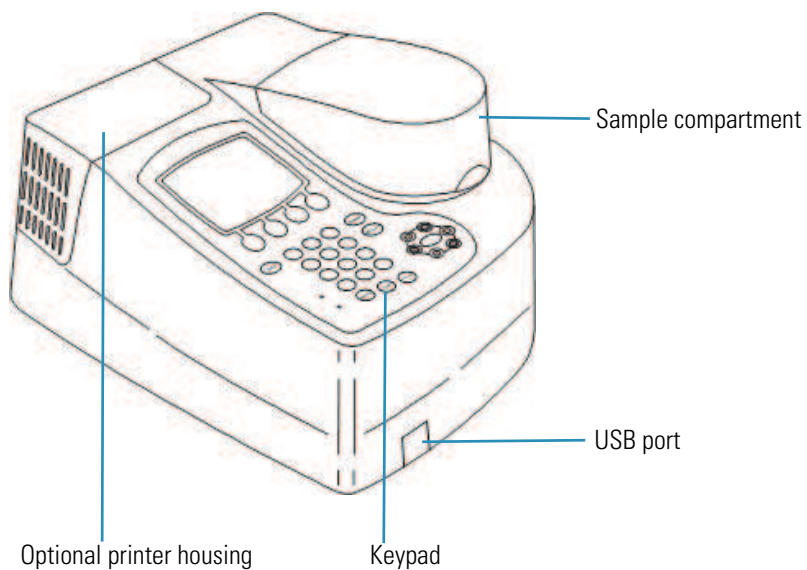

Connectors

The connectors are on the back of the instrument:

1 Spectrophotometer Basics

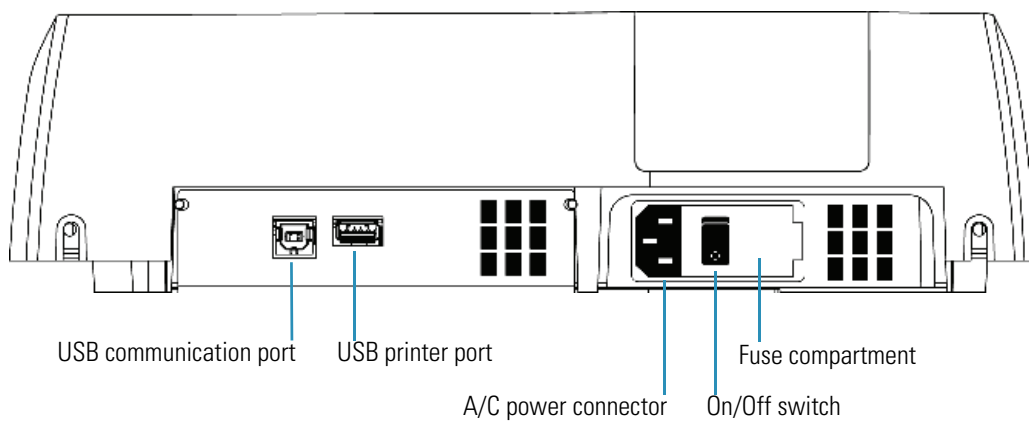

Spectrophotometer Components



WARNING Avoid shock hazard. Always turn off the instrument and unplug it from the wall outlet or power strip before you unplug the power cord from the instrument connector.

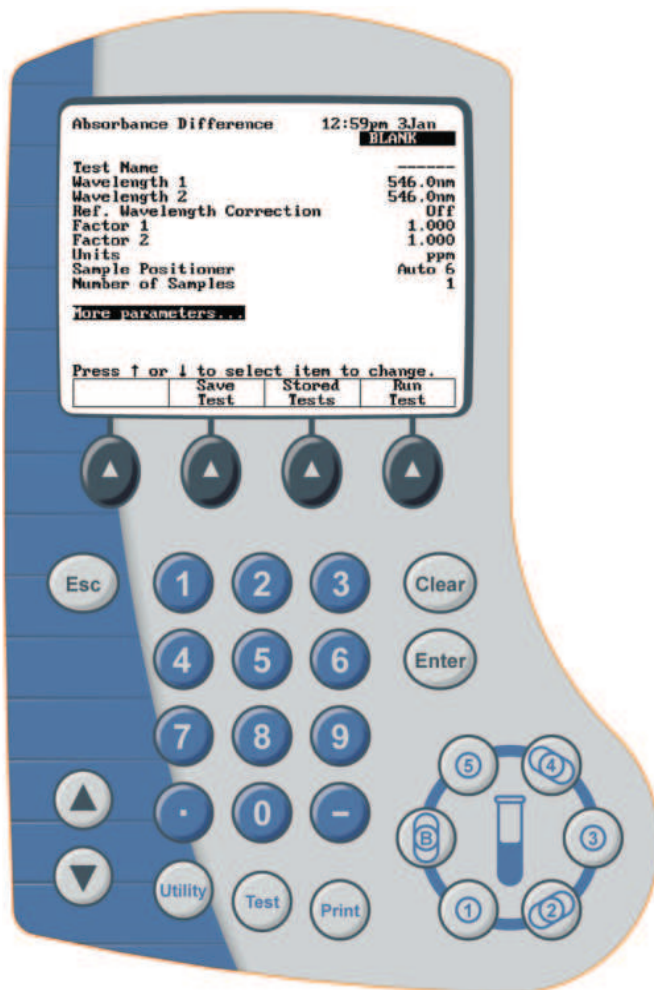











About the Keypad



| Key or button | Function |
|---|--|
|  | <ul style="list-style-type: none"> • Called “Function” keys. • Performs a specific function as displayed above each key. • Functions will change depending on the software screen. • Some function keys may not be active. |
| Function keys | |
|  | <ul style="list-style-type: none"> • Clears the value being entered. • Returns to the previous screen. |
|  | <ul style="list-style-type: none"> • Deletes the last character entered. |

1 Spectrophotometer Basics

Cell Holders

| Key or button | Function |
|---|---|
|  | <ul style="list-style-type: none">• Accepts highlighted, entered, or selected values.• Advances to the next parameter or screen. |
|  | <ul style="list-style-type: none">• Prints the method or results to the selected printer.• If “PC” is selected for the printer, sends the method or results to the USB port. |
|  | <ul style="list-style-type: none">• Displays a menu of software applications. |
|  | <ul style="list-style-type: none">• Displays the Utility screen. |
|  | <ul style="list-style-type: none">• Controls the location of the cursor• Highlights the value or option for the selection. |
|  | |
|  | <ul style="list-style-type: none">• Enters numbers, a decimal point and a minus sign for values. |
|  | <ul style="list-style-type: none">• Cell position keys.• Selects the cell holder position to be measured.• B = blank and 1-5 = sample positions. |
|  | <ul style="list-style-type: none">•    = positions when used in Auto 3 mode. |

Cell Holders

Your instrument includes a 6-position and single cell holder.

6-Position Cell Holder



Single Cell Holder

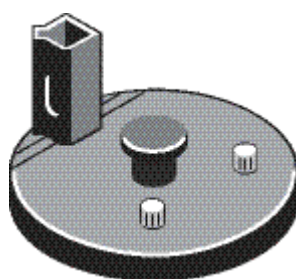

Note If the Cell Positioner method option is set to Auto 6, whenever you press **Run Test** to start a measurement, the instrument attempts to initialize the cell positioner. If a single cell holder is installed, the message “Error, Single Cell Holder found. Use Single Cell Holder?” appears. Press **Accept Change** to continue the measurement with a single cell, or install the 6-cell changer and press **Cancel Change**.

See the parts list for a more detailed list of available accessories.

Selecting and Positioning Cuvettes

The compatible wavelength range for different types of cells depends on the material used.

| Cell Type | Wavelength |
|--------------------|---------------------|
| Optical Glass | 360 nm to > 1100 nm |
| Borosilicate Glass | 330 nm to > 1100 nm |
| Disposable: | |
| Quartz | 190 nm to > 1100 nm |
| Polystyrene | > 340 nm |
| Methacrylate | > 300 nm |
| Acrylic | > 280 nm |
| UV-transparent | > 220 nm |

Note See the manufacturer’s specifications and work within the recommended range.

Note The pathlength of test tubes is not as well defined as that of square cuvettes.

Other Guidelines

Position cuvettes and test tubes so that the clear sides face the light beam, one clear side facing the front of the instrument and the other facing the back.

Note Always place test tubes in the instrument in exactly the same orientation in the light beam. An alignment mark on the test tube helps you orient the test tubes consistently and correctly.

When using small aperture (small volume) cells:

- Always used cells with black masking
- Use the same cell (or cuvette) for your blank and your samples

Z-dimensions

The figure below illustrates the position of the light beam in the instrument.

Beam size specifications are shown below.

- Distance from bottom of cuvette to center of beam (Z-dimension): 8.5 mm
- Beam dimensions: 2 mm (wide) by 7 mm (tall)

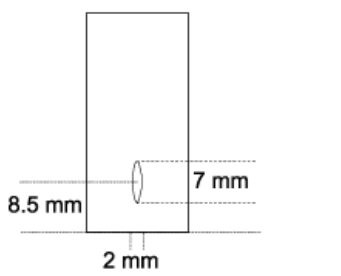

Setting Up the Instrument

Setting up the instrument involves:

- [Entering Parameter Values](#)
- [Setting Utility Parameters](#)
- [Standby Mode](#)
- [Setting Up the Internal Printer](#)

Entering Parameter Values

The following sections describe the use of the keypad to interact with menus and controls. These sections provide instructions for:

- [Numeric Entry](#)
- [Menu Selection](#)
- [On/Off Toggle](#)
- [Alphanumeric Entry](#)

Numeric Entry

With the parameter (e.g., Wavelength) highlighted, start typing the numeric value. An Entry window with the value range appears. Type the complete entry and press **Enter**.

2 Setting Up the Instrument

Entering Parameter Values

```
Advanced A-%T-C          17:02 28Feb07
                        BLANK
Test Name                Copper
Measurement Mode         Conc/Std
Wavelength               546nm
Ref. Wavelength Correction On
Ref. Wavelength          320nm
Delay Time (min:sec)    0:00
Conc of Standard        Undefined
Factor                   Undefined
Units                    C
Sample Positioner       Auto 6
Number of Samples       1

Entry: 4
Enter Wavelength (190 - 1100)
```

| | | | |
|--|--|--|--|
| | | | |
|--|--|--|--|

Alternatively, you can press **Enter** to display the Entry window with the value range and then type the complete entry and press **Enter**.

Menu Selection

With the parameter (Units, or Sample Positioner) highlighted, press **Enter** to display the selection list. Highlight the appropriate item and press **Enter**.

```
Advanced A-%T-C          17:05 28Feb07
Test Name                Copper
Measurement Mo           Conc/Std
Wavelength               546nm
Ref. Wavelength          320nm
Ref. Wavelength          320nm
Delay Time (mi           0:00
Conc of Standa           Undefined
Factor                   Undefined
Units                    C
Sample Positio           Auto 6
Number of Samp           1

More parameter
Press ↑ or ↓ t

C
ppm
ppb
g/L
mg/L
mg/mL
µg/mL
M/L
mM/L
IU
pM/µL
[Unit] -----

Press ↑ or ↓ to select
Press ENTER
```

| | | | |
|--|--|--------|--|
| | | Edit | |
| | | [Unit] | |

On/Off Toggle

With the parameter (e.g., AutoPrint) highlighted, press **Enter** to toggle to the opposite value.

Alphanumeric Entry

With the parameter (e.g., Test Name) highlighted, press **Enter**. The Name Entry screen appears. Highlight the desired character and press **Add Character**. When you are finished, press **Accept Name**.

Create Test Name 17:25 28Feb07

ABCDEFGHIJKLMNOPQRSTUVWXYZ0123456789

abcdefghijklmnopqrstuvwxyz_*/µ()#

Test Name = Copper Test 1

Press ↑ or ↓ to select character.
Press Accept Name to save the test.

| | | | |
|----------------|---------------------|------------------|----------------|
| Delete Name | Delete Character | Add Character | Accept Name |
|----------------|---------------------|------------------|----------------|

Setting Utility Parameters

The Utility menu lets you set certain non-test hardware parameters, such as the date and time, standby setting, screen contrast settings and printer setup. You can also access a directory of all stored tests and the calculator function.

You cannot set utility parameters or change the utility when the instrument is carrying out a measurement.

- Press **Utility** on the keypad.

| | |
|-----------------------------------|---------------|
| Utility | 4:09pm 5Aug09 |
| Software Revision: | 4.000d |
| Instrument Serial Number: | 2R01234567 |
| Printer | PC |
| Date/Time Setup | 4:09pm 5Aug09 |
| Standby | Off |
| Baseline Expiration (hr:min) | Off |
| Beeper | On |
| Language | English |
| % of lamp life used | 0.87% |
| Screen Contrast | |
| Printout Contrast | |
| Stored Tests Directory | |
| USB Drive Files | |
| Calculator | |
| Press ↑ or ↓ to select parameter. | |
| | |

Setting the Date and Time

Highlight **Date/Time Setup** and press **Enter**.

| | | | |
|--|--------------|----------------|--|
| Utility | | 3:39pm 16Mar07 | |
| Set Date | | 16Mar07 | |
| Time Format | | am/pm | |
| Set Time | | 3:39pm | |
| | | | |
| Press ↑ or ↓ to select item to change. | | | |
| Set Day | Set Month | Set Year | |

You can modify the date, time format and time.

❖ **To set the date**

1. Highlight **Set Date** and press **Enter**.
2. Press **Set Date**, type the date and press **Enter**.
3. Press **Set Month**, highlight the correct month and press **Enter**.
4. Press **Set Year**, type the year and then **Enter**.
5. Press **Esc** to save the settings.

❖ **To select the time format**

You can set the instrument to display the time in either am/pm or 24-hour format. To change the format, highlight **Time Format** and press **Enter** until the desired format (AM/PM or 24 hour) appears.

❖ **To set the time**

1. Highlight **Set Time** and press **Enter**.
2. To set the hour, press **Set Hour**, type in the hour and press **Enter**.
3. To set the minutes, press **Set Minute**, type in the minute and press **Enter**.
4. To select between AM and PM (if in AM/PM time format), press **Set AM/PM** until the appropriate setting appears.

Note Your changes are saved automatically (even during power down) by battery backup.

Standby Mode

To prolong lamp life, your spectrophotometer has been pre-set at the factory to automatically go into standby mode after 15 minutes of inactivity.

Setting Baseline Expiration Time

If you will be performing scans on your samples, you can set a time limit for which a collected baseline will be valid. This is particularly useful when measurements are made in a production setting across multiple shifts or when the nature of the blank sample changes dramatically with time.

❖ To set the baseline expiration time

1. Highlight **Baseline Expiration (hr:min)** and press **Enter**.

| | |
|--|----------------|
| Utility | 3:47am 16Mar07 |
| Software Revision: | 1.200 |
| Instrument Serial Number: | ZM7A123005 |
| Printer | Internal |
| Date/Time Setup | 3:47am 16Mar07 |
| Standby | 15 min |
| Baseline Expiration (hr:min) | Off |
| Beeper | On |
| Language | English |
| % of lamp life used | 3.07% |
| Screen Contrast | |
| Printout Contrast | |
| Stored Tests Directory | |
| Entry: Enter time (00:10 - 24:00, 0=OFF) | |
| | |
| | |

2. Enter the desired time in the **Entry baseline expiration time** field and press **Enter**.

Setting the Screen Contrast

To make it easier to read the display, you can adjust the screen contrast on the instrument.

❖ To set the screen contrast

1. Highlight **Screen Contrast** and press **Enter**.

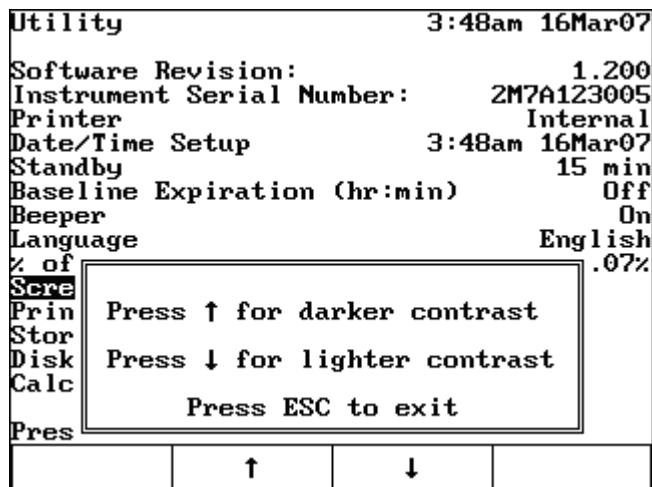

2. Adjust the contrast by following the instructions on the screen.
3. Press **Esc**.

Setting Up the Internal Printer

To set up the internal printer, you need to set its internal parameters and load the paper.

❖ To set up the internal printer

1. Install the internal printer.

If you ordered the internal printer as a separate item, you need to install it. See [“Installing the Internal Printer \(Optional\)”](#) on [page 21](#) section in [Accessories](#) for instructions.

2. Load paper in the printer.

See [“Loading Paper in the Internal Printer”](#) on [page 22](#) in [Accessories](#) for instructions on installing the printer.

Setting the Utility Parameters for the Printer

Paper printouts are available from both the internal printer and a USB printer attached to the instrument. Alternatively, displayed ASCII text and graphics can be sent to a computer using a USB connection.

Enabling the PC as the printing device sends ASCII data to the PC via the USB connection to the PC. No graphics are sent. A program on the PC is required to capture and use the data (not provided).

To ensure that the instrument can output information correctly to the printer, select the appropriate device.

❖ **To set the utility parameters for the printer**

1. Press **Utility**.
2. Highlight **Printer** and press **Enter**.

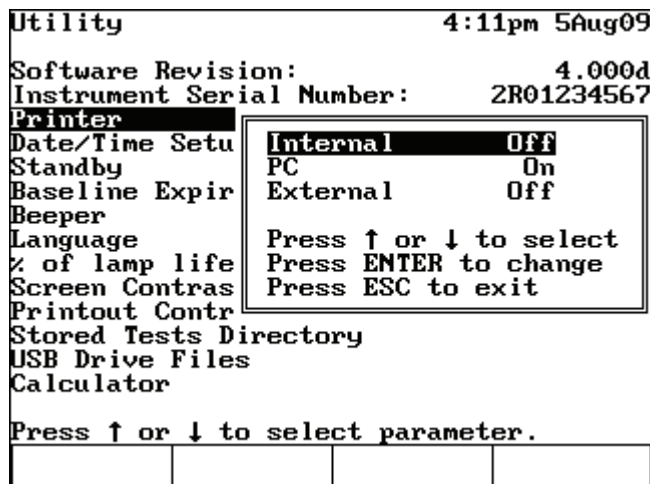

3. Select the printer and press **Enter** until On appears.
4. Press **Esc** to save the settings.

Note Text and graphics can be output via the internal printer and an external printer on the USB port. Only text (no graphics) can be output via the USB connection to a computer.

2 Setting Up the Instrument

Setting Up the Internal Printer

Accessories

This chapter briefly describes the sampling and system accessories that are available for your spectrophotometer. Complete descriptions and operating instructions are included with the accessories.

You can install or remove these accessories without switching off the instrument.

Cell Holders and Cell Holder Accessories

The instrument is shipped with both the 6 Position Cell Holder (installed at the factory) and the Single Cell Holder. Directions to remove and install these cell holders and other cell holder accessories are below.

Cell Holder Configurations

The following table shows the available cell holders and their accessories. You can install or remove accessories without switching off the instrument.

Cell Changer System

Single Cell System

Standard Cell Holders

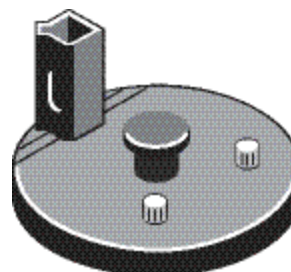

3 Accessories

Cell Holders and Cell Holder Accessories

Cell Changer System

Single Cell System

Accessory Cell Holder Systems

Single Cell Recirculator Temperature Control

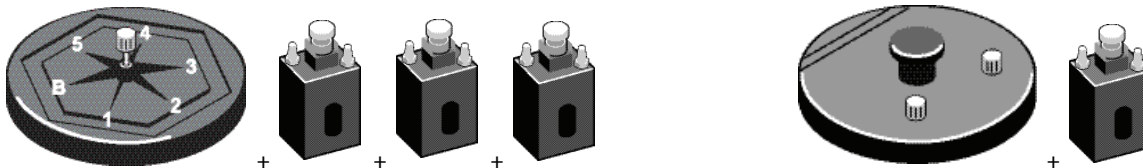

Must be installed in the B, 2 and 4 positions

Test Tube Holder

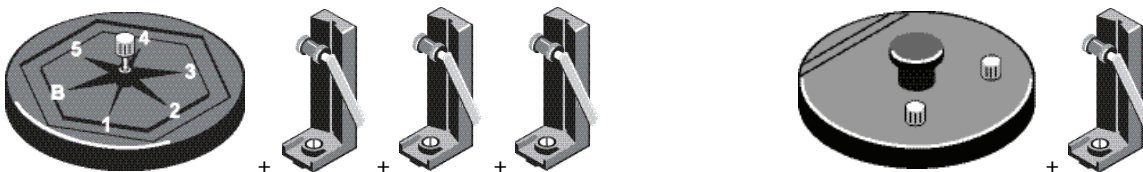

Must be installed in the B, 2 and 4 positions

50 mm Rectangular Long Pathlength Cell Holder

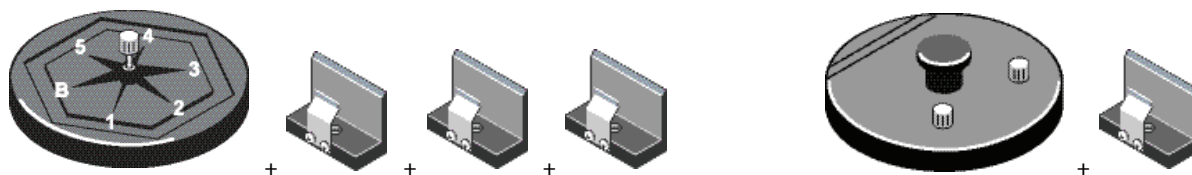

Must be installed in the B, 2 and 4 positions

50 mm Cylindrical Long Pathlength Cell Holder

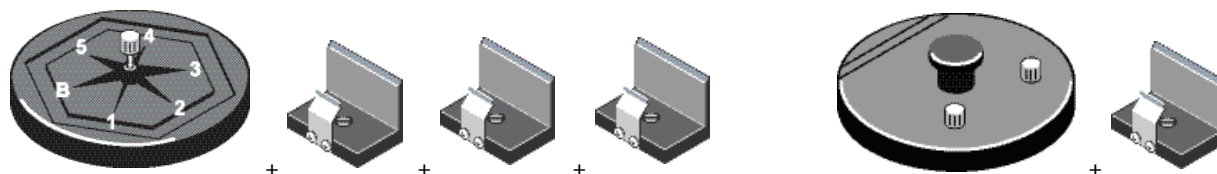

Must be installed in the B, 2 and 4 positions

Cell Changer System

Single Cell System

100 mm Rectangular Long Pathlength Cell Holder

Cannot use 100 mm path cells with Cell Positioner

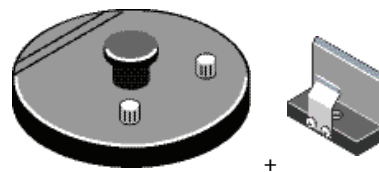

100 mm Cylindrical Long Pathlength Cell Holder

Cannot use 100 mm path cells with Cell Positioner

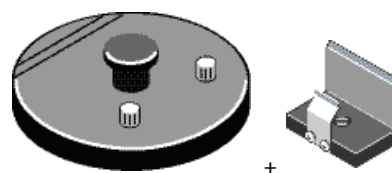

Thin Film/Filter Holders

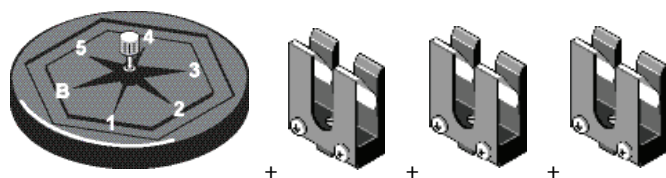

Must be installed in the B, 2 and 4 positions

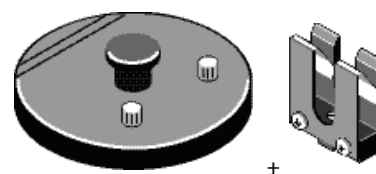

Adjustable Filter/Lens Holder

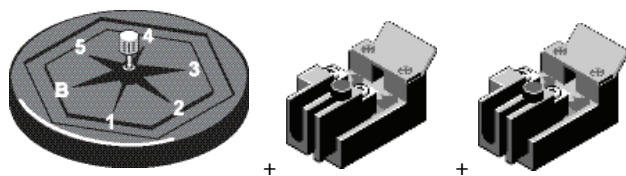

Must be installed in the B, 2 and 4 positions

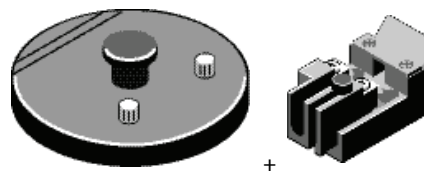

3 Accessories

Cell Holders and Cell Holder Accessories

| Cell Changer System | Single Cell System |
|---|--------------------|
| Combination Systems | |
|  | Not applicable |
| Must be installed in the B, 2 and 4 positions | |

Cell Holder Initialization

When you press **Run Test** to start a measurement, the instrument displays the message “Calibrating and Checking Turret, Please Wait” while it attempts to initialize the cell changer at the Blank position.

If a single cell holder has been installed, the message “Error, Single Cell Holder found. Use Single Cell Holder?” appears. Press **Accept Change** to continue, or install the cell changer and press **Cancel Change**.

If the 6-Position Cell Holder has been installed, it will initialize it to the “B” position. After it has initialized the cell changer, the instrument will display the data collection screen for the test.

Note If, while in this screen, you remove the cell changer and press Run Sample, the instrument will display “Fatal Error: 8 Press Esc to return to main menu.”

Pressing **Esc** returns you to the parameter menu screen of the test. Press **Run Test** and the instrument will now display the message, “Calibrating and Checking Turret, Please Wait” while it attempts to initialize the cell positioner at the Blank position.

If the cell changer is still not in the sample compartment, the instrument will display “Error, Single Cell Holder Found. Use Single Cell Holder?”

Either press **Cancel Change** and reinstall the cell changer or press **Accept Change** to continue with using the single cell holder.

To prevent the Fatal Error whenever removing the cell changer, always return to either the main menu or the test parameter menu of the test before removing the cell changer.

Changing Cell Holders

To:

- use long pathlength cells (cylindrical or rectangular)

- use test tubes
- measure solid samples in the filter holder
- regulate sample temperature via an external liquid recirculator

you must install the appropriate cell holders. The 6-Position Cell Holder installed in the spectrophotometer can easily be removed to install other accessory cell holders. See [“Removing the 6-Position Cell Holder and the Single Cell Holder”](#) on page 20.

Installing the 6-Position Cell Holder and the Single Cell Holder

❖ To install the 6-Position Cell Holder and the Single Cell Holder

1. Open the sample compartment door and let it rest on its hinge.
2. With one hand, carefully lower the cell holder straight down into the sample compartment.

Figure 1. 6-Position Cell Holder

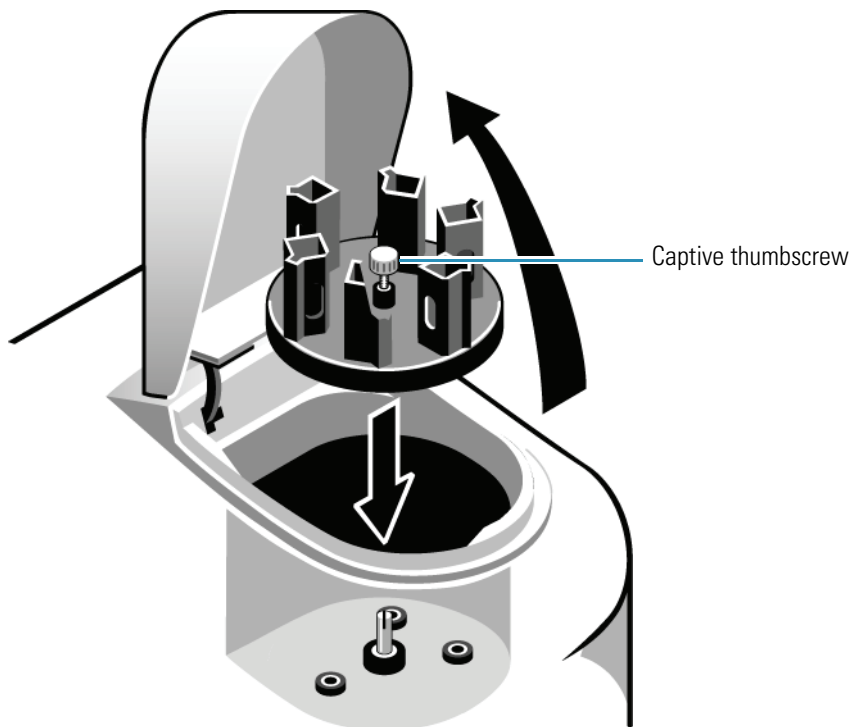

3 Accessories

Cell Holders and Cell Holder Accessories

Figure 2. Single Cell Holder

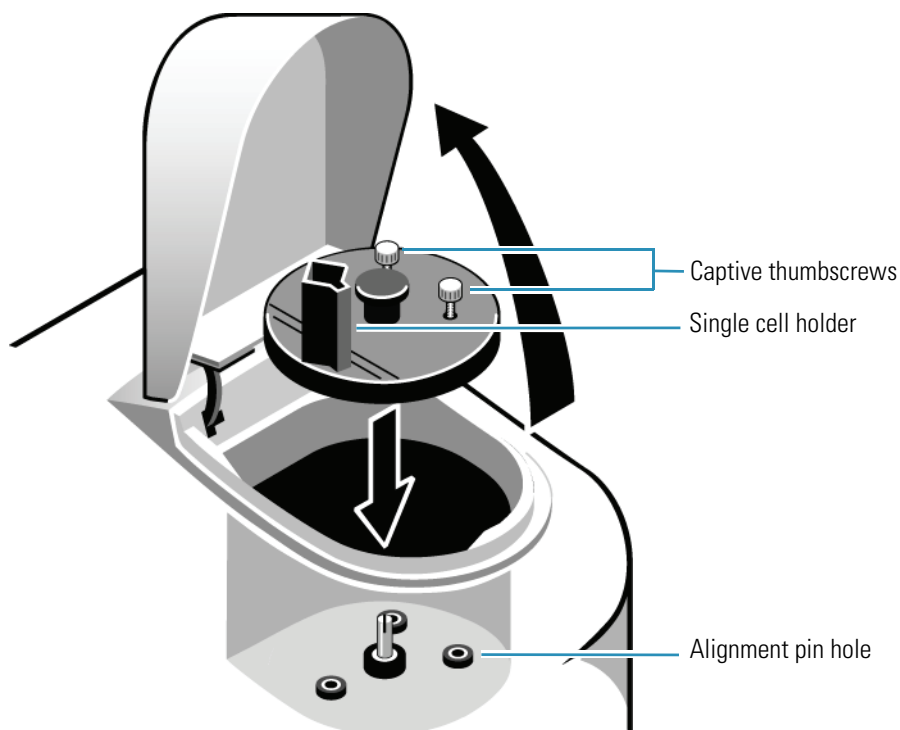

3. With your other hand, tighten the captive thumbscrew(s).
4. Close the sample compartment door.

Note If the cell holder is not aligned correctly, you will not be able to tighten the thumbscrews.

Removing the 6-Position Cell Holder and the Single Cell Holder

❖ To remove the 6-Position Cell Holder and the Single Cell Holder

1. Open the sample compartment door and let it rest on its hinge.
2. With one hand, loosen the captive thumbscrew.
3. With your other hand, pull straight up on the cell holder and lift it out of the sample compartment
4. Close the sample compartment door.

Installing Accessory Cell Holders

Make sure that you have the correct cell holder baseplate installed.

Note To use 100 mm long pathlength cells, you must install the Single Cell Holder baseplate.

See “[Cell Holder Configurations](#)” on [page 15](#) for the different cell holder accessories that can be created for your instrument.

Each of the Cell Holders needs to be installed on either a single-cell baseplate or a multi-cell baseplate by removing the cell holder(s) secured to the baseplate. Each cell holder has a captive screw in the bottom of the holder that secures the holder to the baseplate. Use a flat blade screwdriver to loosen the captive screw from the baseplate and lift the cell holder from the baseplate. Then insert the new cell holder into the appropriate position and secure it to the baseplate by tightening the captive screw.

Note You can install only three each of some accessory cell holders. Be sure to place them in positions B, 2 and 4.

Note Remove the baseplate from the instrument before removing or installing cell holders.

See “[Installing the 6-Position Cell Holder and the Single Cell Holder](#)” on [page 19](#) for instructions on installing the complete accessory assembly in your instrument.

Installing the Internal Printer (Optional)

CAUTION Avoid shock hazard. Turn off the instrument and disconnect the power cord from the outlet before installing the internal printer.

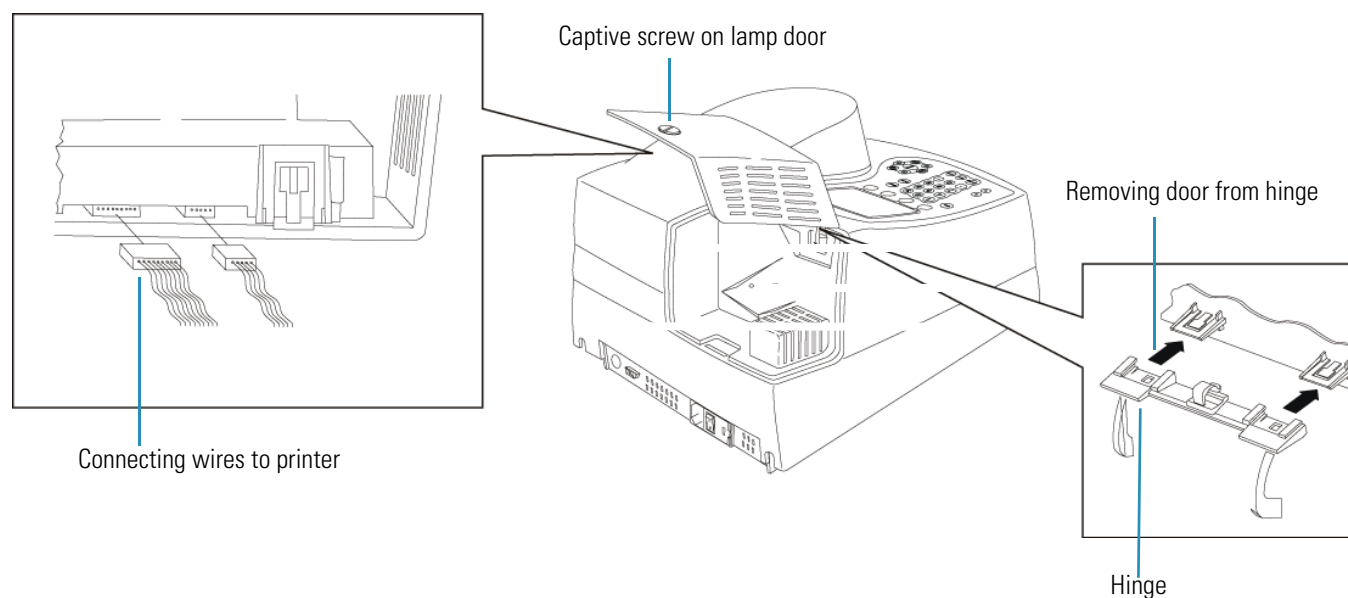

3 Accessories

Installing the Internal Printer (Optional)

❖ To install the internal printer

1. Loosen the captive screw on the lamp door by rotating it counterclockwise about $\frac{1}{4}$ turn.
2. Open the lamp door.
3. Use a pen or screwdriver to lift the tabs holding the door to the hinge.
4. Slide the door off the hinge.
5. Remove the printer assembly (printer installed on the accessory door) from its packing.
6. Lower the hinge so it is out of the way.
7. Connect the wires and press into place with a small screwdriver.

There is only one way that the connectors will fit. Each connector has a slight D shape. Make sure the side of the connector with the shiny metal contacts faces away from the printer and towards the plastic door.

8. Use the clip on the hinge to secure the wires.
9. Install the printer door by sliding it back onto the hinge.
10. Close the lamp door.
11. Tighten the captive screw on the printer door to hold it securely in place.

Loading Paper in the Internal Printer

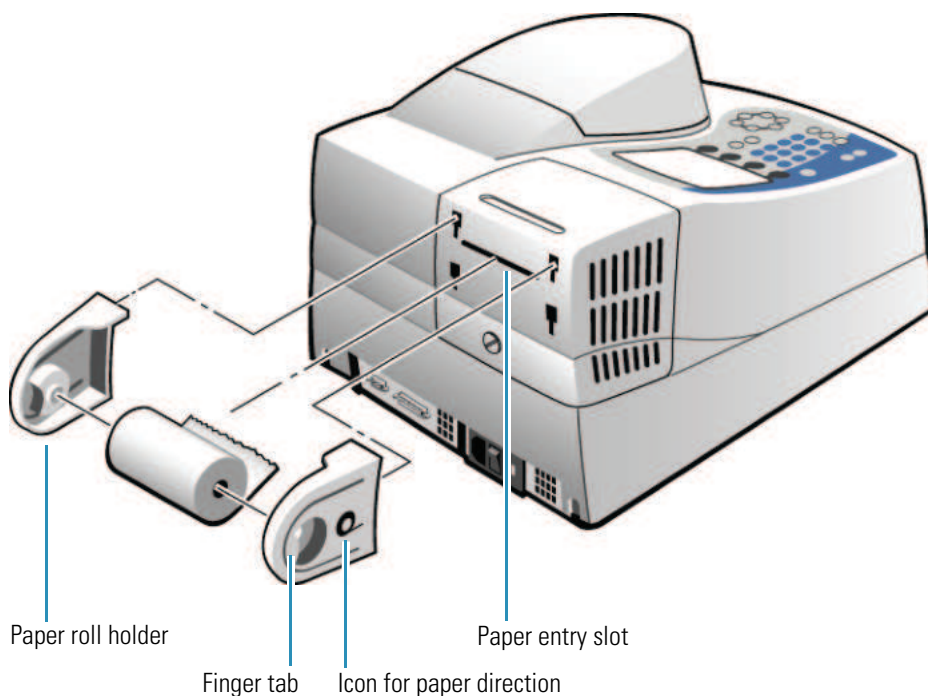

Note Make sure the paper roll holders are in place as shown. When installed correctly, they fit flush with the top of the instrument.

❖ **To load paper in the internal printer**

1. Cut the paper so the edge is even.

Note Arrows on the paper roll holders indicate the direction of the paper feed.

2. Feed the paper straight into the paper entry slot.

The printer grabs the end of the paper and pulls it in.

3. In Basic ATC mode, when the paper stops, press **Enter** to continue advancing the paper until the paper comes out of the paper exit slot.
4. Pull out on the finger tabs on the paper roll holders and secure the roll of paper onto the paper roll holder.

External Printers

Your spectrophotometer is able to print to external desktop printers supporting HP PCL 5.0 format and later.

Note PCL format does not support HP “Windows” printers.

To print to an HP PCL printer, connect the USB cable to the printer and to the USB port on the back of the instrument (see “[Connectors](#)” on [page 1](#)).

Note The instrument is compatible with most HP PCL printers; brands other than HP will also be supported. If the printer is not purchased from Thermo Scientific, it is your responsibility to determine if the printer is compatible with the instrument. Contact technical support or your sales representative for more information.

3 Accessories

External Printers

Sample Positioner Setting

The spectrophotometer lets you use many different cell holders and accessories to take measurements. When you select your test parameters, you select the type of measurement required and indicate the number of samples. You can choose from the following measurement options:

Auto 6

Measure one blank and up to five samples without changing cuvettes in the cell changer. The instrument automatically measures the blank and advances the cell changer to measure the remaining samples.

Auto 3

Measure one blank and two samples without changing cuvettes in the cell changer. The instrument automatically measures the blank and advances the cell changer to measure the samples in positions 2 and 4.

Single Cell Holder

Place the blank in the cell holder, measure it, place a sample in the cell holder, and then measure your sample. This process is completely manual. The cell position buttons do not function when you select Single Cell Holder.

Note You can cause the 6-Cell Changer to function as a single cell holder and measure only one cell by selecting this option. However, we recommend that the single cell holder be used for accessories requiring a high degree of positioning repeatability, such as the nanoCell accessory, small aperture microcells, the coupling module of fiber optics probes, and flowcells used with a sipper system.

Manual 6

Measure a blank and up to five samples without changing cuvettes in the cell changer, using the cell position buttons to advance the cell changer to the appropriate position for the next measurement. Place the blank in the blank position and your samples in the other cell positions. Regardless of where the cell holder is positioned, when you press **Measure Blank** the cell holder automatically goes to the blank position and measures the blank. However, you can use the cell position buttons to select a different position for the measurement.

Note When you have the Cell Changer installed, the instrument always considers the material in the B position as a blank. This means that even after measuring your blank the first time, you can place samples only in positions 1 through 5.

Cell Correction

Every test setup screen provides access to Cell Correction.

Note Cell Correction is not active from the Main (Basic ATC) screen.

Note Cell Correction is active only when the 6-Position Cell Holder is set to either Auto 6 or Auto 3. The feature is not active when the cell holder is set to 1-Cell or Manual 6, nor when the Single Cell Holder is installed.

Before running Cell Correction:

- Clean the inside and outside of all the cells to be matched.
- Fill the cells with distilled water (or other blank solution), and place them in the sample compartment (see “[Selecting and Positioning Cuvettes](#)” on [page 5](#)). Place the blank cuvette in Cell “B” of the cell changer.

Cell Correction

❖ To run Cell Correction

1. Load the test type or stored test.

| | | | |
|--|--------------|-----------------|-------------|
| Advanced A-%T-C | | 15:26 21Feb07 | |
| | | BLANK | |
| Test Name ----- | | | |
| Measurement Mode | Absorbance | | |
| Wavelength | 546.0nm | | |
| Ref. Wavelength Correction | On | | |
| Ref. Wavelength | 545.0nm | | |
| Delay Time (min:sec) | 0:00 | | |
| Sample Positioner | Auto 6 | | |
| Number of Samples | 1 | | |
| More parameters... | | | |
| Press ↑ or ↓ to select item to change. | | | |
| | Save Test | Stored Tests | Run Test |

2. If Cell Correction is not visible, highlight **More parameters** and press **Enter**.

3. Highlight **Cell Correction** and press **Enter**.

| | | |
|--|-----------|---------------|
| Advanced A-%T-C | | 15:28 21Feb07 |
| | | BLANK |
| Cell Correction | | On |
| Setup Correction | | |
| ID# (0=OFF) | | 1 |
| Low/High Limits | | -9999/9999 |
| Statistics | | Off |
| More parameters... | | |
| *Cell Correction Not Calculated | | |
| Press ↑ or ↓ to select item to change. | | |
| | Save Test | Stored Tests |

Cell Correction is now activated, as indicated by the word **On**.

Note When Cell Correction is activated, additional parameter lines are added to the screen above the Cell Correction line. If the Cell Correction line is no longer visible, highlight **More Parameters** and press **Enter**.

4. Highlight **Setup Correction** and press **Enter**.
5. Highlight **Correction Mode** and press **Enter** to set the mode to either:

Scan – Cell Correction is run on a blank and one sample cell for the range of wavelengths you specify in Scanning mode.

Discrete nms – Cell Correction is run on a blank and up to five sample cells for up to 31 user-specified, discrete wavelengths.

| | | |
|----------------------------|--|---------------------|
| Cell Correction | | 4:35am 21Jan01 |
| | | BLANK |
| Correction Mode | | Discrete nms |
| Date Corrected | | |
| Sample Positioner | | Auto 6 |
| Number of Matched Cuvettes | | 1 |

Press ↑ or ↓ to select item to change.

| | | | |
|---------|--|--|-----------|
| Set nms | | | Run Corr. |
|---------|--|--|-----------|

6. If you selected Scan mode in the preceding step, specify the **Start Wavelength** and the **Stop Wavelength** values.
7. Press **Run Corr.** to start Cell Correction.

If you selected Discrete nms mode, first specify the wavelengths using the following procedures, and then Cell Correction.

Cell Correction measures the other cells against the blank and records, stores and dates the measurements. From these measurements Cell Correction establishes the required correction factors, which then are automatically applied during all subsequent tests (if Cell Correction is activated).

Specifying Wavelengths for Discrete nms Mode

❖ To specify wavelengths for Discrete nms mode

1. Highlight **Sample Positioner** and press **Enter** to set this parameter to either Auto 3 (when using three large cell holders) or Auto 6 (when using six small cell holders).
2. Highlight **Number of Matched Cuvettes** and press **Enter**.
3. Specify the number of cells you are matching and press **Enter**.

```

Cell Correction          3:12pm 24Jan01
                        BLANK
Correction Mode          Discrete nms
Date Corrected          -----
Sample Positioner       Auto 6
Number of Matched Cuvettes 1
  
```

| | | | |
|--|--|--|--|
| Entry: | | | |
| Enter Number of Samples (1 - 5) | | | |
| | | | |

4. Press **Set nms** to select the wavelengths for which Cell Correction will be run.
A list of wavelengths appears.

5 Cell Correction

Cell Correction

Cell Correction

15:33 26Jun02

BLANK

| | nm |
|----------|------|
| 1 | 600 |
| 2 | 540 |
| 3 | 450 |
| 4 | ---- |

Entry: **405**
Enter Wavelength (190 - 1100)

| | | | |
|--|--|--|--|
| | | | |
|--|--|--|--|

Note Match cells at all analytical wavelengths. Matching at one does not guarantee matching at others.

5. Highlight the position where you want to enter the first wavelength.
6. Press **Add nm**.
7. Enter the value for the wavelength and press **Enter**.
8. After entering all the wavelengths, press **Run Corr.** to start Cell Correction.

The application measures the other cells against the blank and records, stores and dates the measurements. From these measurements the application establishes the required correction factors, which are applied during all subsequent tests (if Cell Correction is activated).

Managing Stored Tests

The instrument uses test method files containing the values for all parameters needed to run a test, including those for cell changer alignment and installed accessories. After setting the parameters, you can assign a unique test name and save the test. You can then restore the test and run it without having to set the parameters again.

When you power-down the instrument, the current test is maintained by battery backup. When you turn the instrument on again, the cell holder alignment and values for all parameters are the same as when the instrument was last used. If you load a saved test, the values for all parameters stored with it replace the current values of the test parameters.

Software Password

This password lets you “lock” test setups (test parameters) so they may not be overwritten or deleted. The password also lets you remove the security so you may edit the test parameters. See the Lock/Unlock section for more information on locking a test.

Note This password cannot be changed.

Password: 4363797

Note Tests stored on a USB memory device cannot be locked or unlocked.

Naming a Test

When saving a test, specify its file name using up to eight alphanumeric characters.

❖ To name a test

1. After setting the test parameters, highlight **Test Name** and press **Enter**.

| | | | |
|--------------------------------------|--|------------------|----------------|
| Create Test Name | | 12:21 21Feb07 | |
| ABCDEFGHIJKLMNOPQRSTUVWXYZ0123456789 | | | |
| abcdefghijklmnopqrstuvwxyz_*/p()# | | | |
| Test Name = | | | |
| Press ↑ or ↓ to select character. | | | |
| Press Accept Name to save the test. | | | |
| | | Add Character | Accept Name |

This screen lets you:

- Delete the test name
 - Delete a character in the name
 - Add a character to the name
 - Accept the name
2. Highlight the first character for the test name and press **Add Character**.
 3. Continue selecting and adding characters until the name is complete.
 4. Press **Accept Name**.

Saving a Test

After a method has been configured, there are two options for saving a test. The test method can be saved to an external memory device using the front USB port or to the internal memory of the spectrophotometer.

| | | | |
|--|------------|---------------|----------|
| Scanning | | 2:53pm 7Aug09 | |
| | | BLANK | |
| Test Name | Cobalt ion | | |
| Measurement Mode | Absorbance | | |
| Start Wavelength | 400.0nm | | |
| Stop Wavelength | 500.0nm | | |
| Sample Positioner | Auto 6 | | |
| Scan Speed | Fast | | |
| Interval | 1.0nm | | |
| Cell Correction | Off | | |
| ID# (0=OFF) | 1 | | |
| Auto Print | On | | |
| Auto Save Data | Off | | |
| Press ↑ or ↓ to select item to change. | | | |
| | Save Test | Stored Tests | Run Test |

❖ To save a test in the instrument library

1. Press **Save Test**.

A prompt appears:

| | | | |
|--|-------------------------------|---------------|--|
| Scanning | | 4:14pm 5Aug09 | |
| | | BLANK | |
| Test Na | Save as an internal test | | |
| Measure | Save test to the USB drive | | |
| Start W | Save test to internal and USB | | |
| Stop Wa | Press ↑ or ↓ to select | | |
| Sample | Press ENTER | | |
| Scan Sp | Press ESC to exit | | |
| Interva | | | |
| Cell Co | | | |
| ID# (0=OFF) | 1 | | |
| Auto Print | On | | |
| Auto Save Data | Off | | |
| Press ↑ or ↓ to select item to change. | | | |
| | | | |

2. Select the appropriate location and press **Enter**.
3. Create or enter a name for the test.

Use the procedure in “Naming a Test” on page 31.

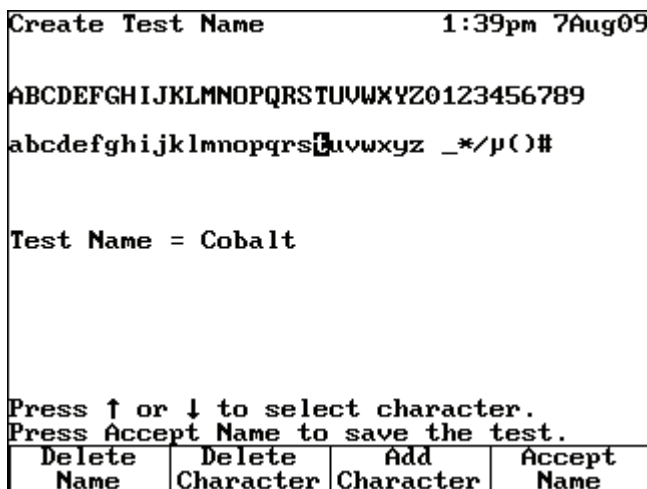

4. Press **Accept Name**.
5. Select whether the test is included as a SmartStart test.
See "[SmartStart](#)" on page 37.

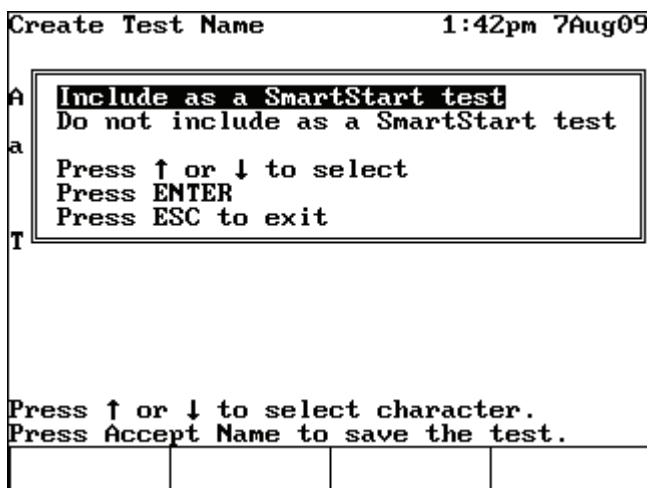

6. Highlight the appropriate SmartStart option and press **Enter** to save the test.

Loading Test Files

You can load saved test files from the internal memory from the Utility screen.

❖ **To load test files**

1. To access all test files, press **Utility**.
2. Highlight **Stored Tests Directory** and press **Enter**.

```

Utility Test Directory      12:25 21Feb07
Nucleic Acid Tests
DNA (260/280)              Read-only
DNA (260/230)             Read-only
DNA with Scan (260/280)   Read-only
DNA with Scan (260/230)   Read-only
dsDNA                     Read-only
ssDNA, RNA                Read-only
Oligos (entered factor)   Read-only
Oligos (calc factor)      Read-only
Direct UV (260)           Read-only
Protein Tests
Bradford-Standard         Read-only
Bradford-Micro            Read-only
Lowry-Standard            Read-only
More tests...
Press ↑ or ↓ to select test.
Select      Load
Test        Test
  
```

Note To view the stored tests of a particular test type, press **Test**, select a test type, and press **Stored Tests**.

Lock/Unlock

To lock or unlock a test, highlight it and press **Lock/Unlock**.

Enter the password and press **Enter**.

```

Utility Test Directory      9:31 22Feb07

Protein Tests
Lowry-Micro                Read-only
BCA-Standard               Read-only
BCA-Micro                  Read-only
Biuret                     Read-only
Direct UV (280)            Read-only
Direct UV (205)            Read-only
Warburg-Christian          Read-only
Cell Growth
Cell Growth                 Read-only
Scanning
Assay51                     22Feb07
More tests...
  
```

Press ↑ or ↓ to select test.

| | | | |
|----------------|----------------|----------------|--------------|
| Select Test | Lock Unlock | Delete Test | Load Test |
|----------------|----------------|----------------|--------------|

Note To lock or unlock access to the file, you must enter the software password of this manual.

Deleting a Test

To delete a test, highlight it and press **Delete Test**.

6 Managing Stored Tests

Deleting a Test

SmartStart

The SmartStart™ feature lets you customize the spectrophotometer by placing the most frequently used test methods on the first menu. Right after the instrument initializes, a simple menu containing only the SmartStart tests appears.

If you select one test as a SmartStart test, the instrument, when powered on, automatically loads this test and prepares for immediate measurement.

If you select more than one test as SmartStart tests, the instrument, when powered on, automatically displays a menu containing only those tests.

Note You can always access the default main menu by pressing **Test**.

❖ To set up a single test SmartStart

1. Press **Utility** to display the Utility screen.

| | |
|-----------------------------------|---------------|
| Utility | 11:04 28Feb07 |
| Software Revision: | 0.014b |
| Instrument Serial Number: | |
| Printer | Off |
| Date/Time Setup | 11:04 28Feb07 |
| Standby | 15 min |
| Baseline Expiration (hr:min) | Off |
| Beeper | On |
| % of lamp life used | 1.21% |
| Screen Contrast | |
| Printout Contrast | |
| Stored Tests Directory | |
| Calculator | |
| Press ↑ or ↓ to select parameter. | |
| | |

2. Highlight **Stored Tests Directory** and press **Enter**.
3. Highlight the appropriate test and press **Select Test**.

An arrow sign “>” indicates the test has been selected for the SmartStart menu.

Press **Esc** to return to the Utility screen, or power down the instrument.

❖ **To unselect a test**

1. Press **Utility**.
2. Highlight **Stored Tests Directory** and press **Enter**.
3. Highlight the test to be removed and press **Unselect Test**.

The Main Menu will be displayed upon power up.

❖ **To set up a multiple test SmartStart**

1. Follow steps 1 through 3 in the procedure above for setting up a single test SmartStart.
2. Select the desired tests.

An arrow sign “>” indicates the tests selected for the SmartStart menu.

Press **Esc** to return to the Utility screen, or power down the instrument.

Note To remove tests from the SmartStart menu, see the procedure above for unselecting a test.

Concentration Units

This chapter covers:

- [Specifying Concentration Units](#)
- [Creating Custom Units](#)

Specifying Concentration Units

Concentration and kinetics tests include a parameter for units, which labels the results. The spectrophotometer includes a set of basic concentration units.

All programs in the spectrophotometer use the same list of basic units:

- C (concentration)
- $\mu\text{g/L}$
- ppm
- M/L
- ppb
- mM/L
- g/L
- IU
- mg/L
- pM/ μL
- mg/mL
- ng/ μL

Custom units can also be created; for more information, see [“Creating Custom Units”](#) on page 40.

❖ To select the units

1. Highlight **Units** and press **Enter**.

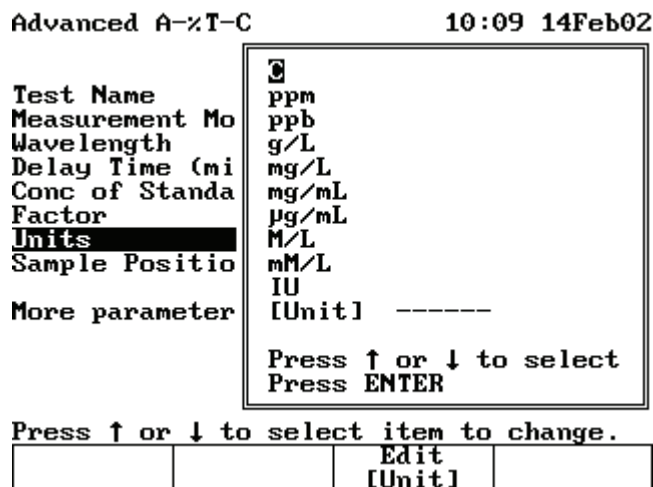

2. Highlight the unit you want to select and press **Enter**.

Creating Custom Units

In addition to the basic concentration units, you can create a custom concentration unit and add it to the list. This custom concentration unit can be changed when desired.

Note Only one custom concentration unit is available in the list at one time.

❖ To create custom units

1. With the Units Selection window displayed, press **Edit [Unit]**.

Use this screen to:

- Delete the name of a unit
 - Delete a character in the name of a unit
 - Add a character to the name of a unit
 - Accept the name of a unit
2. Follow steps 2 through 4 in “Naming a Test” on page 31.

The new custom unit appears in the list of basic units.

Calculator Function

❖ To use the Calculator function

1. From the Utility menu, highlight **Calculator** and press **Enter**.
2. Use the numeric keypad to enter the desired value.
3. Press the desired function (+, -, x or ÷).
4. Enter the second desired value and press **Enter**.

Note You can only add, subtract, multiply, or divide two lines of numbers at a time.

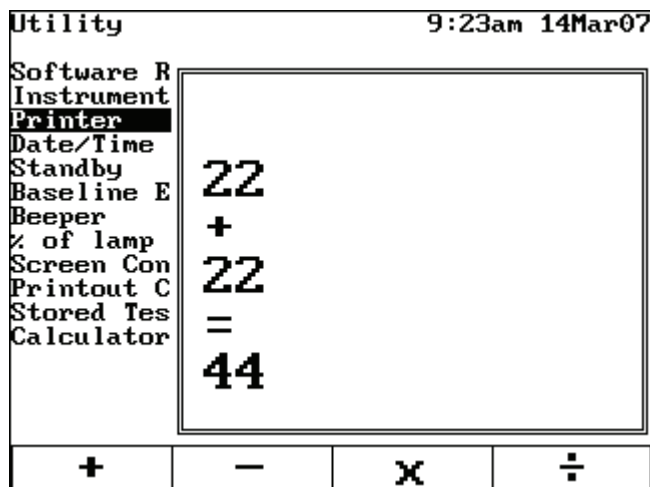

9 Calculator Function

Abs and %T Measurements—Basic A-%T-C

Basic ATC mode puts the instrument into an “instant measurement” mode. The user simply walks up to the instrument, inserts a sample and measures it. Depending on whether the mode is set to Absorbance (A), % Transmittance (%T), or Concentration, the result appears, along with the type of measurement, the date and time, the wavelength and the cell position used for the measurement.

To toggle between Absorbance, %Transmittance, and Concentration, press **Change Mode**. You can toggle modes whenever you see Change Mode.

Absorbance 16:03 31Jan02
BLANK

0.476A
660.0nm

| | | | |
|------------------|--|-----------|----------------|
| Measure Blank | | Set nm | Change Mode |
|------------------|--|-----------|----------------|

When Basic ATC is set to Absorbance or % Transmittance, these capabilities are provided:

- [Setting the Wavelength](#)
- [Measuring a Blank](#)
- [Measuring Samples](#)

Setting the Wavelength

❖ To set the wavelength

1. Press **Set nm** or any number key to set the wavelength.

Absorbance

17:25 1Apr01
BLANK

0.219A

546nm

Enter Wavelength (190 - 1100)

Set
nm

2. Enter the wavelength for taking measurements and press **Set nm** again.

Measuring a Blank

❖ To measure a blank

1. Place the blank in the cell holder.

If a 6-Position Cell Changer is installed, place the blank in the B position.

2. To enter an absorbance or transmittance value for the blank, press a number key and enter the desired value in the **Entry** field.
3. Press **Measure Blank**.

Measuring Samples

If a 6-Position Cell Changer is installed, place the samples in the cell positions and press the corresponding cell position button to move the cell holder to the measuring position. The absorbance (ABS) or percent transmittance (%T) measurement appears on the display.

If a Single Cell Holder is installed, remove the blank and place the sample in the cell holder. The absorbance or %Transmittance measurement appears on the display.

Abs and %T Measurements—Advanced A-%T-C

Use the Advanced A-%T-C application for Absorbance or %Transmittance measurements that include Cell Correction or a measurement delay time, or for automating the measurement of multiple samples with a cell changer. This section covers:

- Selecting the measurement mode (Absorbance or %Transmittance)
- Cell Correction
- Recalling a Test
- Setting Up Test Parameters
- Taking Measurements

To get started, press **Test**, highlight **Advanced A-%T-C** and press **Enter**.

```

Advanced A-%T-C                11:42 4Feb02
                               BLANK
-----
Test Name                      -----
Measurement Mode                Absorbance
Wavelength                      546.0nm
Delay Time (min:sec)            0:00
Sample Positioner               Auto 6
Number of Samples               1

More parameters...
  
```

Press ↑ or ↓ to select item to change.

| | | | |
|--|--------------|-----------------|-------------|
| | Save Test | Stored Tests | Run Test |
|--|--------------|-----------------|-------------|

Recalling a Test

❖ To recall a test

1. In the Advanced A %T C screen, press **Stored Tests**.
2. Highlight the test you want to recall and press **Enter**.

Use this screen for:

- [Setting Up Test Parameters](#)
- [Cell Correction](#)
- [Saving a Test](#)
- [Viewing the list of stored tests](#)
- [Taking Measurements](#)

Setting Up Test Parameters

❖ To set up test parameters

1. Highlight the desired parameter.

Some parameters appear only if you select one of the concentration modes, while others appear regardless of the selected measurement mode. See “Parameters” on [page 117](#) for a complete list.

2. When the parameters are set, press **Save Test** to save the test or **Measure Sample** to measure a blank or samples.

Taking Measurements

❖ To take measurements automatically (using Auto 6 or Auto 3)

1. Press **Run Sample**.
2. Install the blank and samples.
3. Press **Measure Sample**.

❖ To take measurements manually (using Manual 6 or Single Cell Holder)

1. Press **Run Sample**.
2. When prompted, place the blank and samples into the cell holder.

If the 6-Position Cell Holder is installed, place the blank in the B position and the samples in positions 1 to 5.

3. Press **Measure Blank**.

If a 6-Position Cell Holder is installed, it moves to the B position to measure the blank and returns to its previous position.

4. Press **Measure Sample**.

The sample measurement appears. If a 6-Position Cell Holder is installed, press the cell position buttons to reposition the cell holder and measure the rest of the samples manually.

11 Abs and %T Measurements—Advanced A-%T-C

Taking Measurements

Basic Concentration Measurements—Basic A-%T-C

This chapter covers:

- [Basic Concentration Measurements](#)
- [Using Conc/Std to Measure Concentration](#)
- [Using Conc/Factor to Measure Concentration](#)
- [Measuring Samples](#)

Basic Concentration Measurements

Use Basic ATC mode to make basic concentration measurements. This basic concentration mode is useful for very simple comparisons that do not require a standard curve. You cannot save data in this application or factors used when a single standard is measured. For better accuracy and the ability to save and recall methods and data, use the Standard Curve application mode described in [“Concentration Measurements—Standard Curve Application”](#) on [page 83](#).

Measuring concentration using the Basic ATC mode is similar to measuring Absorbance or %T. Basic ATC mode lets you measure concentration using either a factor or one standard to convert absorbance readings to concentration units.

- When using a factor, specify the factor and concentration units.
- When using a standard, specify the concentration of the standard and measure its absorbance.

When Basic ATC is set to Conc/Std or Conc/Factor, you can perform these tasks.

- [Setting the Wavelength and Mode](#)
- [Measuring a Blank](#)
- [Measuring a standard or entering a factor](#)
- [Measuring Samples](#)

The steps for taking measurements in the two modes are similar—the only difference is whether you measure a standard or enter a factor.

Setting the Wavelength and Mode

❖ To set the wavelength and mode

1. Press **Set nm** or any other number key to set the wavelength.
2. Enter the wavelength for taking measurements and press **Set nm** again.
3. Press **Change Mode** until the appropriate measurement mode (Concentration with Standard or Concentration with Factor) appears.

Using Conc/Std to Measure Concentration

In this mode a standard sample of well known concentration is used to determine the concentration of samples. The concentration of unknown samples is determined ratiometrically from the measured standard. The measurement can be expressed mathematically as

$$\frac{\text{Standard Concentration}}{\text{Abs / \%T of Standard}} = \frac{\text{Sample Concentration}}{\text{Abs / \%T of Unknown Sample}}$$

where the standard concentration is precisely known, the Abs/%T of the standard and the Abs/%T of the unknown sample are measured, and the sample concentration is calculated.

❖ To use Conc/Std to measure concentration

1. If necessary, press **Change Mode** to switch to the Concentration with Standard mode.

```
Conc/Std          16:15 31Jan02
Factor=1          (-----)
Std=1 C          BLANK
```

0.4780

660.0nm

| Measure | Units/ | Set | Change |
|---------|----------|-----|--------|
| Blank | Standard | nm | Mode |

If a 6-Position Cell Changer is installed, place the blank in the B position, and the standard in position 1.

2. Press **Measure Blank**.

If the Single Cell Changer is installed, remove the blank and place the standard in the cell changer.

3. Press **Units/Standard** to set the units and measure the standard.
4. Press **Enter Conc**, enter the concentration value of the standard and press **Enter**.
5. Press **Select Units**, highlight the appropriate unit in the list and press **Enter**.
6. Press **Measure Standard**.

The instrument measures the absorbance of the standard and displays the absorbance and calculated factor.

Using Conc/Factor to Measure Concentration

In this mode a concentration factor is used to determine the concentration of samples. The concentration of unknown samples is determined ratiometrically from the entered factor. The measurement can be expressed mathematically as

$$(\text{Abs} / \%T \text{ of Sample}) * \text{Factor} = \text{Concentration of Sample}$$

where the factor is entered, the Abs/%T of the sample is measured, and the sample concentration is calculated.

❖ To use Conc/Factor to measure concentration

1. If necessary, press **Change Mode** to switch to the Conc With Factor mode.
2. Press **Units/Factor** to set the factor and select the units.

```

Conc with Factor          15:29 6Mar01
                          BLANK
Factor                    45
Units                     C
  
```

Press ↑ or ↓ to select item to change.

| | | | |
|--|-----------------|-----------------|--|
| | Enter Factor | Select Units | |
|--|-----------------|-----------------|--|

3. Press **Enter Factor**.
4. Type the desired factor value.

5. Press **Enter Factor** to accept the factor and return to the screen displaying the factor and units.
6. Press **Select Units**.
7. Highlight the appropriate unit in the list and press **Enter**.
8. Press **Esc** to return to the Conc With Factor screen.

Measuring Samples

If the 6-Position Cell Changer is installed, place the sample you want to measure in one of the cell positions and press the corresponding cell position button to move the cell changer to the measuring position.

The measurement appears.

If the Single Cell Changer is installed, remove the blank and place the sample in the cell changer. The measurement appears.

Concentration Measurements—Advanced A-%T-C

Use the Advanced A-%T-C application for concentration measurements for:

- Selecting a measurement mode (concentration with one standard or concentration with a factor).
- [Recalling a Test](#)
- [Setting Up Test Parameters](#)
- [Measuring a Standard](#) or [Entering a Factor](#) (only if you select either concentration with one standard or concentration with a factor)
- [Measuring a Blank](#)
- [Measuring Samples](#)

To get started, press **Test**, highlight **Advanced A-%T-C** and press **Enter**.

```

Advanced A-%T-C          15:40 26Jun02
                        BLANK
Test Name                AAA
Measurement Mode         Conc/Std
Wavelength               546nm
Ref. Wavelength Correction Off
Delay Time (min:sec)     0:00
Conc of Standard         100.0
Factor                   1587
Units                    C
Sample Positioner        Auto 6
Number of Samples        4
  
```

More parameters...

Press ↑ or ↓ to select item to change.

| | | | |
|----------|------|--------|------|
| Run | Save | Stored | Run |
| Standard | Test | Tests | Test |

Recalling a Test

❖ To recall a test

1. Press **Stored Tests**.
2. Highlight the test and press **Enter** or **Load Test** to display the parameters for the selected test.

Setting Up Test Parameters

❖ To set up test parameters

1. Highlight the desired parameter.

Some parameters appear only if you select a concentration mode, while others appear regardless of the selected measurement mode.

See [Parameters](#) for a complete list.

2. When the parameters are set, press **Save Test** to save the test or **Run Standard** to measure a standard (if in Conc/Std), or press **Run Test** (if in Conc/Factor).

Measuring a Standard

❖ To measure a standard automatically (using Auto 6 or Auto 3)

1. With Measurement Mode set to Conc/Std, press **Run Standard**.

```
Advanced A-%T-C          10:17 20Feb02
Test Name: STANDARD TEST  BLANK
Conc.      Abs      Factor
  ppb      650.0nm  calculated
-----

```

| | | | |
|--|--|--|--|
| Entry: Enter a number (0.001 to 9999) | | | |
| | | | |

2. Enter the concentration of the standard and press **Enter**.
3. Press **Measure Blank**.
4. Insert the blank and standard.
5. Press **Enter** to measure the blank and samples and display the absorbance and calculated factor.

❖ To measure a standard manually (using Manual 6 or Single Cell Holder)

1. Press **Run Standard**.
2. Enter the concentration of the standard and press **Enter**.
3. Insert the blank and standard.

4. Press **Measure Blank**.

If a 6-Position Cell Holder is installed, it moves to the B position to measure the blank and returns to its previous position.

5. Press **Measure Standard**.

The instrument measures the absorbance of the standard and displays the absorbance and calculated factor.

Entering a Factor

❖ To enter a factor

Highlight **Factor**. To change the factor, enter the correct factor.

To change the units, highlight **Units** and select the correct units.

Measuring Samples

❖ To measure a sample automatically (using Auto 6 or Auto 3)

1. Press **Run Test**.
2. When prompted, place the blank and samples in their cell positions and press **Enter**.
The instrument measures the blank and samples and displays the sample measurements.
3. Press **Measure Sample** to measure additional samples.

❖ To measure samples manually (using Manual 6 or Single Cell Holder)

1. Press **Run Test**.
2. Insert the blank and sample.
A 6-Position Cell Holder can hold five samples.
3. Press **Measure Blank**.
If a 6-Position Cell Holder is installed, it moves to the B position to measure the blank and returns to its previous position.
4. Press **Measure Sample**.
If a 6-Position Cell Holder is installed, press the cell position buttons to reposition the cell holder and measure the rest of the samples manually.

13 Concentration Measurements—Advanced A-%T-C

Measuring Samples

Scanning

The wavelength scanning application lets you measure the absorption or percent transmission spectrum of a sample. You can use scans to determine peak wavelengths or to evaluate the quality of a material.

Use the Scanning application for:

- [Recalling a Test](#)
- [Setting Up Test Parameters](#)
- [Cell Correction](#)
- [Collecting a Baseline Scan](#)
- [Scanning a Sample](#)
- [Viewing and Manipulating Scan Data](#)
- [Rescaling Graphical Scan Data](#)
- [Determining Peak Height Using a 3-point Net Equation](#)
- [Calculating the Area Under a Curve](#)
- [Labeling Peaks and Valleys](#)

Note The Scanning application lets you measure only one sample at a time. Auto 6, Auto 3 and Manual 6 are not available for scanned measurements.

Note To set a baseline expiration time, press **Utility** and then highlight **Baseline Expiration**. Press **Enter** and set the desired time.

To get started, press **Test**, highlight **Scanning** and press **Enter**.

Recalling a Test

❖ To recall a test

1. Press **Stored Tests**.
2. Highlight the test you want to recall and press **Enter**.

The parameters for the selected test appear.

This screen provides these capabilities:

- [Setting Up Test Parameters](#)
- Setting up Cell Correction

| | | | |
|--|--------------|-----------------|-------------|
| Scanning | | 4:19pm 5Aug09 | |
| | | BLANK | |
| Test Name ----- | | | |
| Measurement Mode | Absorbance | | |
| Start Wavelength | 400.0nm | | |
| Stop Wavelength | 500.0nm | | |
| Sample Positioner | Auto 6 | | |
| Scan Speed | Fast | | |
| Interval | 1.0nm | | |
| Cell Correction | Off | | |
| ID# (0=OFF) | 1 | | |
| Auto Print | On | | |
| Auto Save Data | Off | | |
| Press ↑ or ↓ to select item to change. | | | |
| | Save Test | Stored Tests | Run Test |

Setting Up Test Parameters

❖ To set up test parameters

1. Highlight the desired parameter.
2. When the parameters are set, press **Save Test** to save the test or **Run Test** to measure a blank or a sample.

Note If Cell Correction is ON, you must run the Setup Correction application before you can access Run Test or Measure Samples.

Note If Auto Save Data is ON, you must enter a Data File Name before you can access Run Test or Measure Samples.

Collecting a Baseline Scan

Note If a 6-Position Cell Holder is installed, be sure to place the blank in the B position. The instrument always uses the B position to collect the baseline.

❖ To collect a baseline scan

1. Press **Run Test**.
2. Place the blank in the B position.

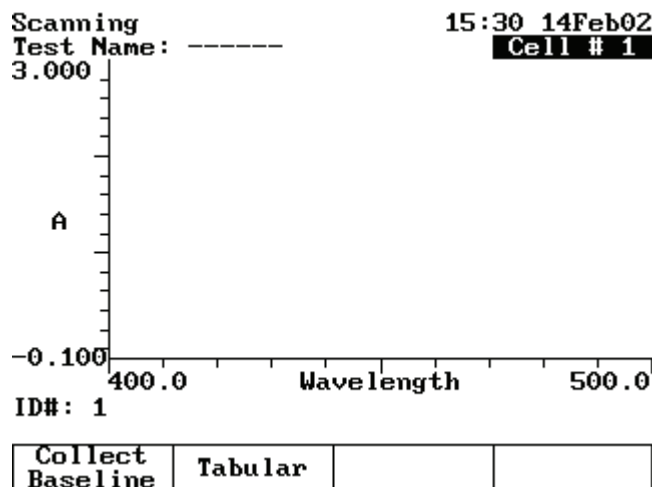

3. Press **Collect Baseline**.

While the spectrophotometer is measuring the baseline, a status message appears indicating the progress of the baseline scan. After the baseline is measured, this message disappears.

Note To switch between tabular and graphical displays, press **Graph/Tabular**.

Scanning a Sample

Note If a 6-Position Cell Holder is installed, be sure to place the sample in cell position #1. The instrument always uses cell position #1 to scan the sample.

❖ To scan a sample

1. Press **Run Test**.

If a 6-Position Cell Holder is installed, place the sample in cell position #1.

2. Press **Measure Sample**.

Note To switch between tabular and graphical displays, press **Graph/Tabular**.

Note If Auto Save Data is ON, you must enter a Data File Name before you can access Run Test or Measure Samples.

14 Scanning

Viewing and Manipulating Scan Data

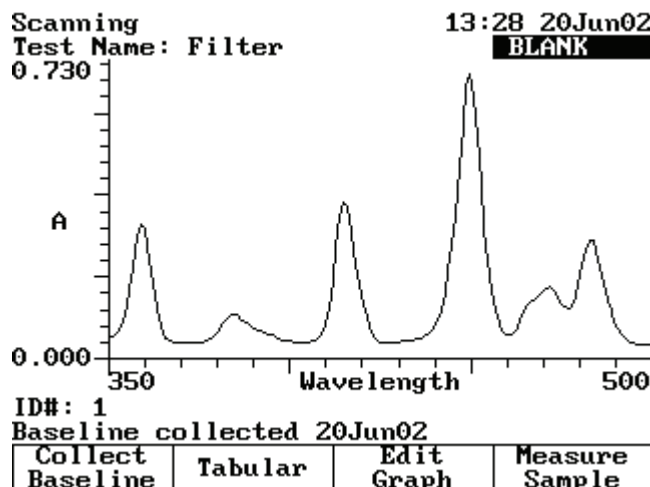

Viewing and Manipulating Scan Data

The Scanning application lets you view and manipulate results in graphical or tabular form.

When working with graphical scan data, press **Edit Graph** before performing other functions on the data.

The edit graph screen provides these capabilities:

- [Rescaling Graphical Scan Data](#)
- [Determining Peak Height Using a 3-point Net Equation](#)
- [Performing Calculations on the Scan Data](#)
- [Labeling Peaks and Valleys](#)

Rescaling Graphical Scan Data

You can modify the scale of your scan data plot automatically or manually. When you select Auto Scale, the instrument scales the X- and Y-axes so all the data appears on the plot. When you select Manual Scale, you select specific minimum and maximum values for the axes. When you modify the scale, the instrument recalculates and displays the new data plot.

Press **Edit Scale** to modify the scale. In the edit scale screen, you can:

- Use **Auto Scale** to change the scale and display the new graph.
- Use **Manual Scale** to change the scale and display the new graph.
- Use the cursor to identify specific points along the X-axis.

❖ **To use the Auto Scale function**

With your scan data displayed on the edit scale screen, press **Auto Scale**. The instrument adjusts the minimum and maximum values for the X- and Y-axes so all the data appears on the plot.

❖ **To use the Cursor**

1. With your scan data displayed on the edit scale screen, press **Cursor**.

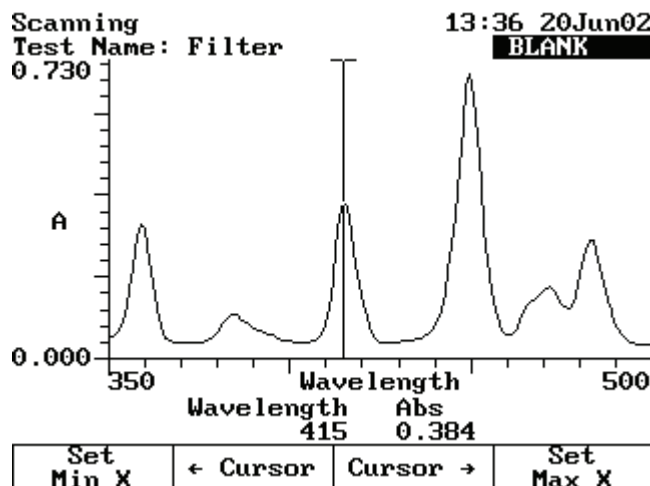

2. Use **Cursor ←** to move to the desired minimum wavelength value. Press **Set Min X** to redraw the plot using the new minimum wavelength value.
3. Repeat using **Cursor →** and **Set Max X** to set the new maximum wavelength.

❖ **To use the Manual Scale function**

1. Press **Manual Scale** to display the manual scale options.

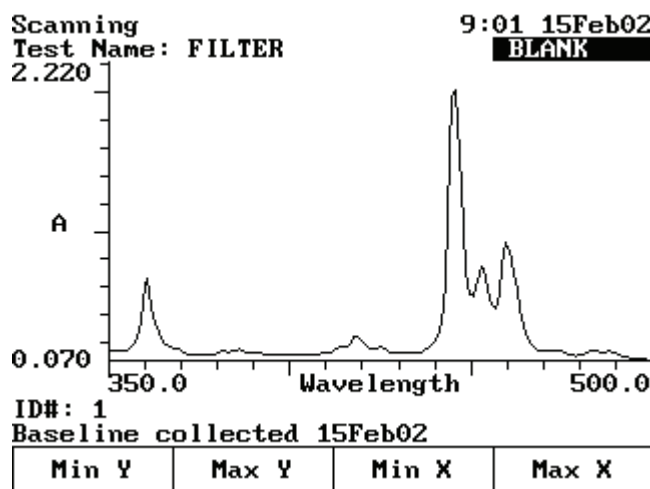

2. To set the minimum or maximum value for the X- or Y-axis, press **Min Y**, **Max Y**, **Min X** or **Max X**.

14 Scanning

Viewing and Manipulating Scan Data

3. Enter the correct value and then press **Min Y**, **Max Y**, **Min X** or **Max X** to accept it.

The instrument redraws the plot using the entered minimum and maximum values.

Performing Calculations on the Scan Data

You can modify your graph by performing calculations on the data. In the Edit Graph screen, press **Math**.

The Math screen provides these capabilities:

- Labeling Peaks and Valleys
- Smoothing Data
- Calculating the Area Under a Curve
- Determining Peak Height Using a 3-point Net Equation

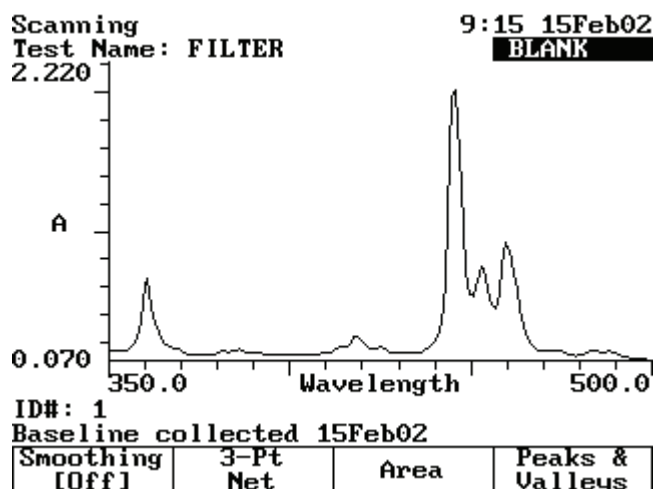

Labeling Peaks and Valleys

❖ To label valleys and peaks

1. With your scan displayed on the edit graph screen, press **Math**.

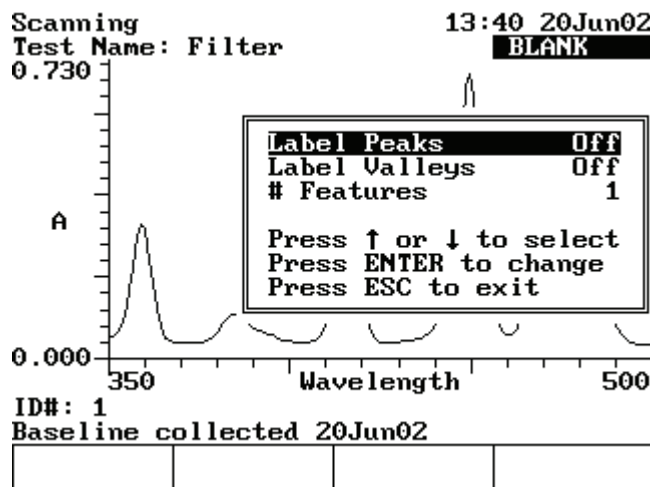

2. Press **Peaks & Valleys** to display the Label Peaks and Valleys window.
3. Select the type of labels to display and press **Enter**.

The instrument labels the selected items on your scan data plot.

Note Up to nine peaks or valleys can be calculated and displayed.

Smoothing Data

If your scan shows sampling noise, you can smooth the data with the smoothing function.

❖ To smooth data

With your scan data displayed on the edit graph screen, press **Smoothing [On]**.

Determining Peak Height Using a 3-point Net Equation

❖ To determine 3-point net measurements

1. With your scan data displayed on the edit graph screen, press **Math**.
2. Press **3-Pt Net**.

The 3-point net measurement screen shows the cursor options and three cursor lines (designated for the left, center and right wavelengths).

14 Scanning

Viewing and Manipulating Scan Data

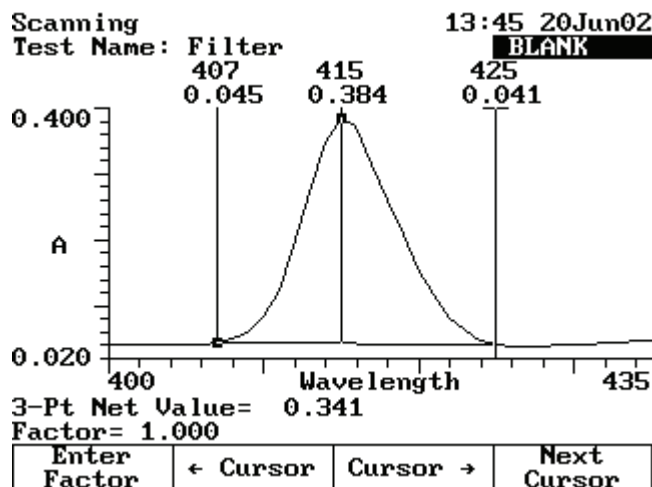

3. Use **Cursor** → and **Cursor** ← to position the left cursor line to the desired wavelength value.

The instrument calculates the 3-point net absorbance for the selected wavelengths.

4. Continue selecting the other wavelengths by pressing **Next Cursor** to activate the center and right cursor lines.

Select the wavelengths with **Cursor** ← and **Cursor** →.

Repeat until all three wavelengths have been selected.

5. Press **Enter Factor** to access the set factor box. Enter the desired factor and press **Enter**.

The instrument calculates the value for the 3-point net absorbance for the selected wavelengths, multiplied by the selected factor.

Calculating the Area Under a Curve

❖ To calculate the area under a curve

1. With your scan data displayed on the edit graph screen, press **Math**.
2. Press **Area** to display the Area Under the Curve measurement screen.

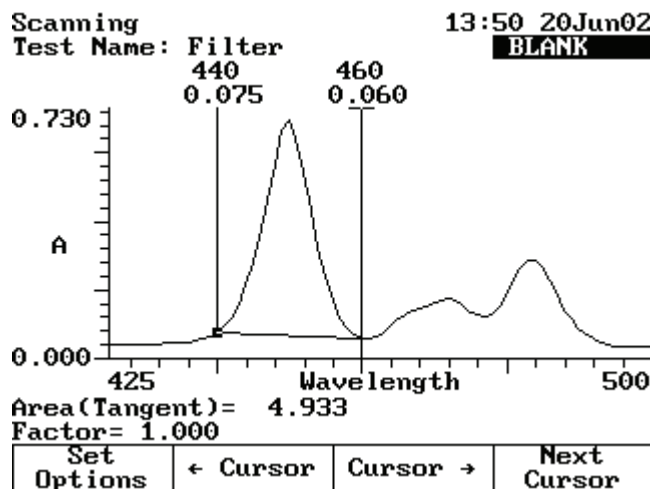

3. Use **Cursor** → and **Cursor** ← to position the left cursor line to the desired wavelength value.

The instrument calculates the area under the curve for the selected wavelengths.

4. Continue selecting the other wavelengths by pressing **Next Cursor** to activate the next cursor line.

Select the wavelength with **Cursor** → and **Cursor** ←.

5. Press **Set Options** to access the set options window.
6. Highlight **Factor**. Enter the desired factor and press **Enter**.
7. Highlight **Calculation baseline**.
8. Press **Enter** to toggle between Zero and Tangent.
9. Press **Esc** to return to the area under a curve screen.

The instrument calculates the area under a curve for the selected wavelengths, factor and calculation method.

Viewing and Rescaling Tabular Scan Data

When working with tabular scan data, you must press **Edit Data** before performing other functions on the data.

14 Scanning

Viewing and Manipulating Scan Data

Scanning 10:05 15Feb02
Test Name: FILTER **BLANK**

| | Wavelength | Abs |
|---|------------|-------|
| → | 350.0 | 0.140 |
| | 351.0 | 0.139 |
| | 352.0 | 0.140 |
| | 353.0 | 0.139 |
| | 354.0 | 0.137 |
| | 355.0 | 0.138 |
| | 356.0 | 0.150 |
| | 357.0 | 0.180 |
| | 358.0 | 0.231 |
| | 359.0 | 0.364 |

ID#: 1
Baseline collected 15Feb02

| Use all data | Graph | Start nm | End nm |
|--------------|-------|----------|--------|
|--------------|-------|----------|--------|

❖ To use all the scan data

With your table of scan data displayed on the edit screen, press **Use All Data**.

❖ To select specific start and end wavelengths

1. With your table of scan data displayed on the edit screen, highlight the appropriate data point in the table.
2. Press **Start nm** or **End nm**.

The instrument highlights the selected data points.

To display the plot using the highlighted data points, press **Graph**.

Multiwavelength

The Multiwavelength application lets you make multiple fixed-wavelength measurements. It is a fast alternative to scanning if the wavelengths of interest are well known.

Use Multiwavelength for:

- [Recalling a Test](#)
- [Setting Up Test Parameters](#)
- [Cell Correction](#)
- [Adding Wavelengths and Factors](#)
- [Deleting Wavelengths and Factors](#)
- [Taking Measurements](#)

To get started, press **Test**, highlight **Multiwavelength** and press **Enter**.

```
Multiwavelength          10:30 22Feb07
                        BLANK
Test Name                -----
Measurement Mode        Absorbance
Sample Positioner       Auto 6
Number of Samples       1
Cell Correction         Off
ID# (0=OFF)            1
```

Press ↑ or ↓ to select item to change.

| | | | |
|---------|-----------|--------------|--|
| Set nms | Save Test | Stored Tests | |
|---------|-----------|--------------|--|

Recalling a Test

❖ To recall a test

1. Press **Stored Tests**.
2. Highlight the test to recall and press **Enter** to display its parameters.

This screen provides these capabilities:

- [Setting Up Test Parameters](#)
- [Cell Correction](#)
- [Saving a Test](#)
- Viewing the list of stored tests
- [Taking Measurements](#)

Setting Up Test Parameters

❖ To set up test parameters

In the Multiwavelength screen, highlight the desired parameter.

See the procedures below for instructions on [adding](#) or [deleting](#) wavelengths and factors.

If you have previously selected the wavelengths to measure, press **Save Test** to save the test or **Run Test** to measure a blank or samples.

If you have not selected the wavelengths, you can add wavelengths and factors as shown below.

Note If Cell Correction is ON, you must run the Setup Correction application before you can access Run Test or Measure Samples.

Note If Auto Save Data is ON, you must enter a Data File Name before you can access Run Test or Measure Samples.

Adding Wavelengths and Factors

Note You can enter factors only when the measurement mode is set to Concentration/Factor.

❖ To add wavelengths and factors

1. Press **Set nms**.

| Multiwavelength | | 4:20pm 5Aug09 | |
|------------------|-------|---------------|--|
| Test Name: ----- | | BLANK | |
| WL# | nm | Factor | |
| 1 | 340.0 | 56.85 | |
| 2 | 532.0 | 630.8 | |
| 3 | 633.0 | 0.052 | |
| 4 | ----- | ----- | |

Page 1
Press ↑ or ↓ to view data

| | | | |
|------|-----------|--|-------------|
| Edit | Add nm | | Run Test |
|------|-----------|--|-------------|

2. Highlight a position for entering the first wavelength and factor pair.
3. Press **Add nm**.
4. Enter the values for the wavelength and factor and press **Enter**.
5. When the values are correct, press **Add nm**.
6. Continue until you have entered all the wavelengths and factors.

Deleting Wavelengths and Factors

❖ To delete wavelengths and factors

1. Press **Set nms**.

Note If no wavelength values have been entered, the wavelength and factor columns will be empty.

2. Highlight the first wavelength and factor pair to delete.
3. Press **Delete nm**.

Taking Measurements

You can access Multiwavelength acquisition from either the Set nms screen shown above or from the Multiwavelength setup screen.

❖ To take measurements automatically (Auto 6 or Auto 3)

1. Press **Run Test** to display the Multiwavelength measurement screen.

Multiwavelength 4:46pm 18Feb02
Test Name: ----- **BLANK**
ID#: 1

| nm | Result |
|-------|--------|
| ----- | Abs |

Insert sample 1
into position 1
Press ENTER to measure

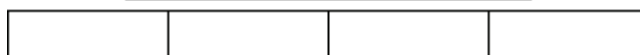

2. Install the blank and samples.
3. Press **Enter**.

❖ **To take measurements manually (using Manual 6 or Single Cell Holder)**

1. With the Multiwavelength screen displayed and the parameters set, press **Run Test**.
2. Install the blank and samples.

If a 6-Position Cell Holder is installed, place the blank in the B position. The holder can hold five samples.

3. Press **Measure Blank**.

If a 6-Position Cell Holder is installed, it moves to the B position to measure the blank and returns to its previous position.

4. With the list of wavelengths (and factors) displayed, press **Measure Samples** to measure and display the absorbance at each wavelength.

If you set the measurement mode to Concentration/Factor, the calculated concentration at each wavelength also appears.

If a 6-Position Cell Holder is installed, press **Cell Position** to reposition the cell holder and measure the rest of the samples manually.

Absorbance Ratio

The Absorbance Ratio application lets you measure the absorption ratio of two different wavelengths. Reference wavelength correction is available to eliminate the effects of a sample matrix. Typically used in quality control applications, an absorbance ratio provides a convenient and quick diagnostic test for sample quality.

Use Absorbance Ratio for:

- [Recalling a Test](#)
- [Setting Up Test Parameters](#)
- [Cell Correction](#)
- [Measuring a Blank](#)
- [Measuring Samples](#)

To get started, press **Test**, highlight **Absorbance Ratio** and press **Enter**.

Recalling a Test

```

Absorbance Ratio          10:32 20Feb02
                          BLANK
Test Name                  456[Saved]
Wavelength 1              260.0nm
Wavelength 2              280.0nm
Ref. Wavelength Correction Off
Sample Positioner         Auto 6
Number of Samples         5
More parameters...
  
```

```

Press ↑ or ↓ to select item to change.
┌──────────┬──────────┬──────────┬──────────┐
│           │ Save     │ Stored   │ Run      │
│           │ Test    │ Tests   │ Test    │
└──────────┴──────────┴──────────┴──────────┘
  
```

❖ To recall a test

1. In the Absorbance Ratio screen, press **Stored Tests**.

2. Highlight the test to recall and press **Enter**.

This screen provides these capabilities:

- [Setting Up Test Parameters](#)
- [Cell Correction](#)
- [Saving a Test](#)
- Viewing the list of stored tests
- [Measuring a Blank](#)

Setting Up Test Parameters

❖ To set up test parameters

1. In the Absorbance Ratio screen, highlight the desired parameter.
2. When the parameters are set, press **Save Test** to save the test or **Run Test** to measure a blank or samples.

Note If Cell Correction is ON, you must run the Setup Correction application before you can access Run Test or Measure Samples.

Note If Auto Save Data is ON, you must enter a Data File Name before you can access Run Test or Measure Samples.

Measuring Samples

```
Absorbance Ratio          13:14 14Feb02
Test Name: -----      BLANK
ID#  Abs  Abs  Abs
    660.0 640.0 Ref.WL  Result
    ---  ---  ---  ---  ---
```

Insert samples 1 - 5
into positions 1 - 5
Press ENTER to measure

| | | | |
|--|--|--|--|
| | | | |
|--|--|--|--|

❖ To measure samples automatically (using Auto 6 or Auto 3)

1. Install the blank and samples.

2. Press **Enter**.

❖ **To measure samples manually (using Manual 6 or Single Cell Holder)**

1. In the Absorbance Ratio screen, press **Run Test**.

2. Install the blank and sample.

A 6-Position Cell Holder can hold five samples.

3. Press **Measure Blank**.

If a 6-Position Cell Holder is installed, it moves to the B position to measure the blank and returns to its previous position.

4. Press **Measure Sample**.

If a 6-Position Cell Holder is installed, press the cell position buttons to reposition the cell holder and measure the rest of the samples manually.

16 Absorbance Ratio

Measuring Samples

Absorbance Difference

The Absorbance Difference application lets you measure the difference in absorption at two different wavelengths. Reference wavelength correction is available to eliminate the effects of a sample matrix. Typically used in quality control applications, an absorbance difference application provides a convenient and quick diagnostic test for sample quality.

Use Absorbance Difference for:

- [Recalling a Test](#)
- [Setting Up Test Parameters](#)
- [Cell Correction](#)
- [Measuring a Blank](#)
- [Measuring Samples](#)

To get started, press **Test**, highlight **Absorbance Difference** and press **Enter**.

```

Absorbance Difference      12:59pm 3Jan02
                           BLANK
Test Name                  -----
Wavelength 1              546.0nm
Wavelength 2              546.0nm
Ref. Wavelength Correction Off
Factor 1                   1.000
Factor 2                   1.000
Units                      ppm
Sample Positioner         Auto 6
Number of Samples         1

More parameters...

Press ↑ or ↓ to select item to change.

|  |      |        |      |
|--|------|--------|------|
|  | Save | Stored | Run  |
|  | Test | Tests  | Test |

```

Recalling a Test

❖ To recall a test

1. In the Absorbance Ratio screen (see [“Using the Absorbance Ratio Screen”](#) on page 76), press **Stored Tests**.

2. Highlight the test to recall and press **Enter**.

Using the Absorbance Ratio Screen

Use this screen for:

- [Setting Up Test Parameters](#)
- [Cell Correction](#)
- [Saving a Test](#)
- Viewing the list of stored tests
- [Measuring a Blank](#)
- [Measuring Samples](#)

Setting Up Test Parameters

❖ To set up test parameters

1. In the Absorbance Ratio screen, highlight the parameter to set.
2. When the parameters are set, press **Save Test** to save the test or **Run Test** to measure a blank or samples.

Note If Cell Correction is ON, you must run the Setup Correction application before you can access Run Test or Measure Samples.

Note If Auto Save Data is ON, you must enter a Data File Name before you can access Run Test or Measure Samples.

Measuring Samples

Absorbance Difference 13:29 14Feb02
Test Name: TEST 9 **BLANK**

| ID# | Abs 429.0 | Abs 630.0 | Abs Ref.WL | Result ppm |
|-------|--------------|--------------|---------------|---------------|
| ----- | ----- | ----- | ----- | ----- |

Insert samples 1 - 5
into positions 1 - 5
Press ENTER to measure

| | | | |
|--|--|--|--|
| | | | |
|--|--|--|--|

❖ **To measure samples automatically (using Auto 6 or Auto 3)**

1. In the Absorbance Difference screen, press **Run Test**.
2. Install the blank and samples.
3. Press **Enter**.

❖ **To measure samples manually (using Manual 6 or Single Cell Holder)**

1. In the Absorbance Difference screen, press **Run Test**.
2. Install the blank and samples.

A 6-Position Cell Holder can hold five samples.

3. Press **Measure Blank**.

If a 6-Position Cell Holder is installed, it moves to the B position to measure the blank and returns to its previous position.

Absorbance Difference 13:39 14Feb02
Test Name: TEST 9 **Cell # 1**

| ID# | Abs 429.0 | Abs 630.0 | Abs Ref.WL | Result ppm |
|-------|--------------|--------------|---------------|---------------|
| ----- | ----- | ----- | ----- | ----- |

| | | | |
|--------------------------|--|--|--|
| Measure Blank | | | |
|--------------------------|--|--|--|

17 Absorbance Difference

Measuring Samples

4. Press **Measure Sample**.

If a 6-Position Cell Holder is installed, press the position buttons to reposition the cell holder and measure the rest of the samples manually.

3-Point Net

The 3-Point Net application lets you determine the height of a peak based on a sloping baseline drawn between two wavelengths on either side of the peak. This type of analysis is beneficial when the precise peak height is needed for a particular assay. A factor can be multiplied by the measured peak height to give the concentration of the measured analyte in the appropriate concentration units.

Use 3-Point Net for:

- [Recalling a Test](#)
- [Setting Up Test Parameters](#)
- [Cell Correction](#)
- [Taking Measurements](#)

To get started, press **Test**, highlight **3-Point Net** and press **Enter**.

```

3-Point Net                10:11 15Feb02
                           BLANK
Test Name                  BILIRUBIN
Wavelength 1              545.0nm
Wavelength 2              546.0nm
Wavelength 3              547.0nm
Factor                    1.000
Units                     C
Sample Positioner         Auto 6
Number of Samples         1

More parameters...

```

Press **↑** or **↓** to select item to change.

| | | | |
|--|--------------|-----------------|-------------|
| | Save Test | Stored Tests | Run Test |
|--|--------------|-----------------|-------------|

Note If Cell Correction is ON, you must run the Setup Correction application before you can access Run Test or Measure Samples.

Note If Auto Save Data is ON, you must enter a Data File Name before you can access Run Test or Measure Samples.

Recalling a Test

❖ To recall a test

1. Press **Stored Tests**.
2. Highlight the test to recall and press **Enter** to display its parameters.

This screen provides these capabilities:

- [Setting Up Test Parameters](#)
- [Cell Correction](#)
- [Saving a Test](#)
- Viewing the list of stored tests
- [Taking Measurements](#)

Setting Up Test Parameters

❖ To set up test parameters

1. Highlight the desired parameter.
2. When the parameters are set, press **Save Test** to save the test or **Run Test** to measure a blank or samples.

Note If Cell Correction is ON, you must run the Setup Correction application before you can access Run Test or Measure Samples.

Note If Auto Save Data is ON, you must enter a Data File Name before you can access Run Test or Measure Samples.

Taking Measurements

❖ To take measurements automatically (Auto 6 or Auto 3)

1. With the 3-Point Net Setup screen displayed and the parameters set, press **Run Test** to display the 3-Point Net measurement screen.

```

3-Point Net          10:25 15Feb02
Test Name: BILIRUBIN  BLANK
ID#  Abs  Abs  Abs  Result
-----
429.0 515.0 630.0  C
  
```

| |
|--|
| Insert sample 1 into position 1 Press ENTER to measure |
|--|

| | | | |
|--|--|--|--|
| | | | |
|--|--|--|--|

2. Install the blank and samples.
3. Press **Enter**.

❖ **To take measurements manually (using Manual 6 or Single Cell Holder)**

1. Press **Run Test**.

```

3-Point Net          9:26 4Feb02
Test Name: 3_PTNET   Cell # 1
ID#  Abs  Abs  Abs  Result
-----
630.0 660.0 680.0  µg/mL
  
```

| | | | |
|--------------------------|--|--|--|
| Measure Blank | | | |
|--------------------------|--|--|--|

2. Install the blank and samples.
If a 6-Position Cell Holder is installed, place the blank in the B position. The holder can hold five samples.
3. Press **Measure Blank**.
If a 6-Position Cell Holder is installed, it moves to the B position to measure the blank and returns to its cell position.
4. Press **Measure Sample**.
If a 6-Position Cell Holder is installed, press the cell position buttons to reposition the cell holder and measure the rest of the samples manually.

18 3-Point Net

Taking Measurements

Concentration Measurements—Standard Curve Application

The Standard Curve application lets you perform a quantitative analysis experiment using a multipoint calibration curve. A calibration curve is composed of standards of well-known concentration. A fit of this standard curve is used to measure the concentration of samples.

Use Standard Curve for:

- Creating a standard curve (set up the parameters and then measure the standards for the curve)
- [Cell Correction](#)
- [Measuring Samples](#)
- Viewing calibration curve data: select between graphical and tabular displays
- [Editing a Standard Curve](#): change the number of standards, select a different curve fit or delete points from the curve.
- Viewing and saving sample data measured using the standard curve

To get started, press **Test**, highlight **Standard Curve** and press **Enter**.

```

Standard Curve          15:28 4Feb02
                        BLANK
Test Name              AMMONIA
Date Standards Measured
Wavelength            660.0nm
Ref. Wavelength Correction Off
Curve Fit             Linear
Number of Standards   5
Units                 ppm
Sample Positioner     Auto 6
Number of Samples     1
  
```

More parameters...

Press ↑ or ↓ to select item to change.

| Run Standards | Save Test | Stored Tests | |
|---------------|-----------|--------------|--|
| | | | |

Recalling a Standard Curve

❖ **To recall a standard curve**

1. Press **Stored Tests**.
2. Highlight the test to recall and press **Enter**.

Setting the Parameters for a Standard Curve

❖ **To set the parameters for a standard curve**

1. Place the standards in their cell positions.
2. Set parameters for measuring the standards.

See “[Parameters](#)” on [page 117](#) for a complete list.

- a. Enter the **Test Name**, **Wavelength**, **Reference Wavelength Correction** and **Reference Wavelength**.
- b. Select the **Curve Fit**, **Units** and **Sample Positioner**.
- c. Set **Number of Standards** and **Number of Samples**.
- d. Enter the low and high limits.
- e. Select the settings for **Statistics** and **AutoPrint**.
- f. Run **Cell Correction**.

Measuring the Standards for a Standard Curve

❖ **To measure standards automatically (using Auto 6 or Auto 3)**

1. Install the blank and standards.
2. When the parameters are correct, press **Run Standards**.

Standard Curve
Test Name: AMMONIA

15:39 4Feb02

BLANK

| Std # | Conc. ppm | Abs 660.0nm |
|-------|-----------|-------------|
| 1 | 0.120 | ----- |
| 2 | 0.200 | ----- |
| 3 | ----- | ----- |
| 4 | ----- | ----- |
| 5 | ----- | ----- |

Entry:
Enter a number (0.001 to 9999)

| | | | |
|--|--|--|--|
| | | | |
|--|--|--|--|

- Set **Entry concentration** and press **Enter**.
- Press **Measure Standards**.

The **Standards screen** shows the absorbance of each standard, along with the slope, intercept and correlation coefficient of the standard curve.

❖ **To measure standards manually (using Manual 6 or Single Cell Holder)**

- Install the blank and standards.
- When the parameters are correct, press **Run Standards**.

Standard Curve
Test Name: AMMONIA

12:50 14Feb02

BLANK

| Std # | Conc. mg/L | Abs 660.0nm |
|-------|------------|-------------|
| 1 | 25.00 | ----- |
| 2 | 45.00 | ----- |
| 3 | 55.00 | ----- |
| 4 | 75.00 | ----- |
| 5 | 100.0 | ----- |

Page 1, Standards 1 - 5

| | | | |
|---------------|-----------|----------------|--|
| Measure Blank | Save Test | Edit Standards | |
|---------------|-----------|----------------|--|

- Set **Entry concentration**.
- Press **Measure Blank**.

If a 6-Position Cell Holder is installed, it moves to the B position to measure the blank and returns to its previous position.

- Press **Measure Standards**.

If a 6-Position Cell Holder is installed, press the cell position buttons to reposition the cell holder and measure the rest of the standards manually.

When all of the standards have been measured, the Standards screen (see “Using the Standards Screen” on page 86) shows the absorbance of each standard, along with the slope, intercept and correlation coefficient of the standard curve.

Using the Standards Screen

Here is an example of the Standards screen showing measurement results:

| Standard Curve | | 15:50 4Feb02 | |
|--------------------|------------|--------------|--|
| Test Name: AMMONIA | | Cell # 5 | |
| Std # | Conc . ppm | Abs 660.0nm | |
| 1 | 0.120 | 0.087 | |
| 2 | 0.200 | 0.140 | |
| 3 | 0.250 | 0.152 | |
| 4 | 0.400 | 0.268 | |
| 5 | 0.500 | 0.312 | |

| | | | |
|-------------|---------|--------------|-------|
| Curve Fit | | Linear | |
| Slope = | 0.6091 | Std Dev = | 0.011 |
| Intercept = | 0.01272 | Corr Coeff = | 0.995 |

| | | | |
|-------------------------|-----------|----------------|----------|
| Page 1, Standards 1 - 5 | | | |
| View Graph | Save Test | Edit Standards | Run Test |

You can use this screen for:

- Displaying a graph of the standard curve data (press **View Graph**)
- [Saving a Test](#) (press **Save Test**)
- [Editing a Standard Curve](#) (press **Edit Standards**)
- [Measuring Samples](#) (press **Run Test**)

Measuring Samples

❖ To measure samples automatically using the calibration curve (using Auto 6 or Auto 3)

1. Press **Run Test**.
2. Install the blank and samples.
3. Press **Enter**.

The Standard Curve screen shows the absorbance and concentration of each sample.

To switch between tabular and graphical displays, press **View Graph/Tabular**.

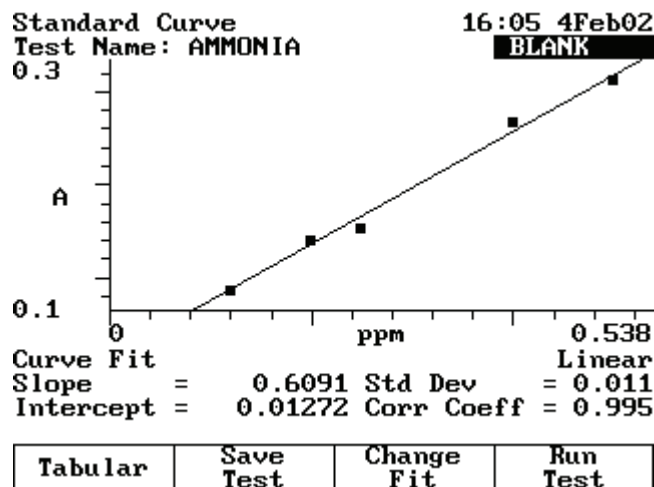

❖ **To measure samples manually (using Manual 6 or Single Cell Holder)**

1. Press **Run Test**.
2. Install the blank and samples.
3. Press **Measure Blank**.

If a 6-Position Cell Holder is installed, it moves to the B position to measure the blank and returns to its previous position.

4. Press **Measure Samples**.

If a 6-Position Cell Holder is installed, press the cell position buttons to reposition the cell holder and measure the rest of the samples manually.

When the instrument has measured all the samples, the Standards screen shows the absorbance and concentration of each sample.

Editing a Standard Curve

You may edit the concentration of any standard on a standard curve. In addition, you may change the number of standards, select a different curve fit or delete points from the curve.

19 Concentration Measurements—Standard Curve Application

Editing a Standard Curve

Standard Curve 11:31am 21Jan01
Test Name: STANDARDCURVE

| Std # | Conc. mg/L | |
|-------|------------|---------------------------|
| 1 | 25.00 | Edit Concentration |
| 2 | 45.00 | Add Standard |
| 3 | 55.00 | Delete |
| 4 | 75.00 | Clear Measurements |
| 5 | 100.0 | Reset Standards |

Press ↑ or ↓ to select
Press ENTER

Curve Fit Linear
Slope = 0.002877 Std Dev = 0.017
Intercept = 0.002364 Corr Coeff = 0.985
Page 1 of 0, Standards 1 - 5
Press ↑ or ↓ to view data

| | | | |
|--|--|--|--|
| | | | |
|--|--|--|--|

❖ To edit the concentration of a standard

1. With the standard curve displayed, highlight the standard to edit and press **Edit Standards**.
2. With **Edit Concentration** highlighted, press **Enter**.
3. Press **Edit Conc** or a number key.
4. Enter the concentration value in the **Entry** field.
5. Press **Enter**.

❖ To add a standard

1. With the standard curve displayed, press **Edit Standards**.
2. Highlight **Add Standard**.
3. Enter the concentration value of the additional standard in the **Entry** field.
4. Press **Enter**.
5. Press **Measure Standards** to remeasure all the standards.

❖ To delete a standard

1. With the standard curve displayed, highlight the standard to delete and press **Edit Standards**.
2. Highlight **Delete Standard** and press **Enter**.

❖ To clear measurements

1. With the standard curve displayed, press **Edit Standards**.
2. Highlight **Clear Measurements** and press **Enter**.

All absorbance measurements are removed from the screen.

❖ **To reset standards**

1. With the standard curve displayed, press **Edit Standards**.
2. Highlight **Reset Standards** and press **Enter**.

All standards and measurements are removed from the screen.

❖ **To select a different curve fit for a standard curve**

Note To change the curve fit for a standard curve, you must display the standard curve as a graph, not as a table.

1. With the standard curve you want to edit displayed as a graph, press **Change Fit**.

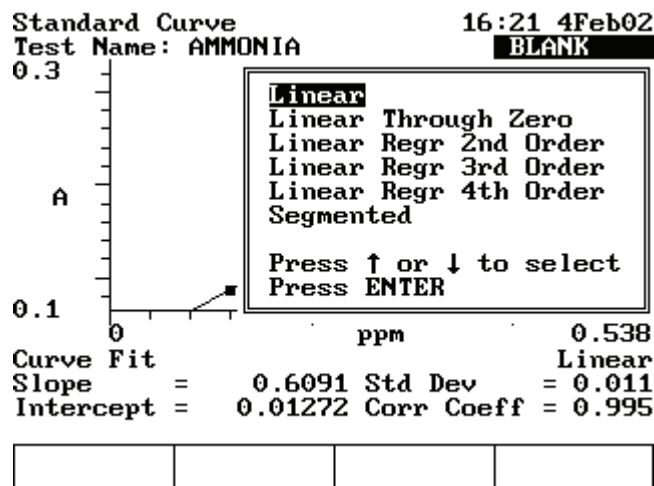

2. Highlight the curve fit to use for the standard curve and press **Enter**.

The instrument applies the selected curve fit to the data and displays the new fit.

19 Concentration Measurements—Standard Curve Application

Editing a Standard Curve

Kinetics

The Kinetics application lets you measure the change in the sample absorbance as a function of time. The local control software allows the determination of a linear rate over a particular region, which can be defined after the data acquisition. Frequently used in enzymatic kinetics, a factor can be multiplied by the slope of the linear rate fit to determine activity.

Computer software control lets you greatly expand the kinetics capabilities of your instrument:

- Multicell parallel kinetics lets you monitor up to five reactions simultaneously. Extended kinetics data acquisition exceeds the 400 data point limit of the embedded software.
- Software control streamlines the use of more sophisticated computer applications to analyze kinetics data after collection.

Use Kinetics for:

- [Recalling a Test](#)
- [Setting Up Test Parameters](#)
- [Cell Correction](#)
- [Measuring a Blank](#)
- [Measuring Samples](#)
- [Recalling and Recalculating Graphical Kinetics Results](#)
- [Rescaling and Recalculating Tabular Kinetics Results](#)
- [Modifying the scale of the plot](#)

You can work with graphical or tabular data and perform the same functions with either. However, the location of the function keys depends on the display type.

Note The Kinetics application lets you measure only one sample at a time.

Note The Kinetics application lets you collect up to 400 data points per run. When setting test parameters, select the interval time and total run time accordingly.

To get started, press the **Test** button, highlight **Kinetics** and press **Enter**.

Recalling a Test

❖ To recall a test

1. In the Kinetics screen, press **Stored Tests**.
2. Highlight the test to recall and press **Enter**

| | | | |
|--|--------------|-----------------|-------------|
| Kinetics | | 4:17pm 5Aug09 | |
| | | BLANK | |
| Test Name ----- | | | |
| Measurement Mode | Absorbance | | |
| Wavelength | 546.0nm | | |
| Ref. Wavelength Correction | Off | | |
| Delay Time (min:sec) | 0:00 | | |
| Interval Time (min:sec) | 0:01 | | |
| Total Run Time (hr:min:sec) | 0:05:00 | | |
| Measure Blank | Once | | |
| Display Result (Rate * Factor) | On | | |
| More parameters... | | | |
| Press ↑ or ↓ to select item to change. | | | |
| | Save Test | Stored Tests | Run Test |

This screen provides these capabilities:

- [Setting Up Test Parameters](#)
- Setting up Cell Correction
- [Saving a Test](#)
- Viewing the list of stored tests
- [Measuring a Blank](#)
- [Measuring Samples](#)

Setting Up Test Parameters

❖ To set up test parameters

1. In the Kinetics screen, highlight the desired parameter.

| Kinetics | | 4:17pm 5Aug09 | |
|--|--------------|-----------------|-------------|
| BLANK | | | |
| Test Name ----- | | | |
| Measurement Mode | Absorbance | | |
| Wavelength | 546.0nm | | |
| Ref. Wavelength Correction | Off | | |
| Delay Time (min:sec) | 0:00 | | |
| Interval Time (min:sec) | 0:01 | | |
| Total Run Time (hr:min:sec) | 0:05:00 | | |
| Measure Blank | Once | | |
| Display Result (Rate * Factor) | On | | |
| More parameters... | | | |
| Press ↑ or ↓ to select item to change. | | | |
| | Save Test | Stored Tests | Run Test |

| Parameter | Description |
|------------------------------------|--|
| Delay Time | Enters the time from Test Initiation to first measurement; allows for sample equilibration Adv. |
| Interval Time | Enters the time between repeated readings |
| Measure Blank (as function key) | Selects the frequency of zeroing the instrument Once or Every Reading |

- When the parameters are set, press **Save Test** to save the test or **Run Test** to measure a blank or sample.

Note If Cell Correction is ON, you must run the Setup Correction application before you can access Run Test or Measure Samples.

Note If Auto Save Data is ON, you must enter a Data File Name before you can access Run Test or Measure Samples.

Measuring Samples

Note If a 6-Position Cell Changer is installed, place the blank in position B and the sample in cell position #1. The instrument always uses cell position #1 to scan the sample.

❖ To measure samples

- In the Kinetics screen, press **Run Test**.
- If a 6-Position Cell Holder is installed, place the blank in position B and the sample in position #1.
- Press **Measure Sample**.

After the measurement, the kinetics data and rate appear.

- If a Single Cell Holder is installed, press **Measure Blank** to measure the blank, insert your sample and then press **Measure Sample**.

After the measurement, the kinetics data and rate appear.

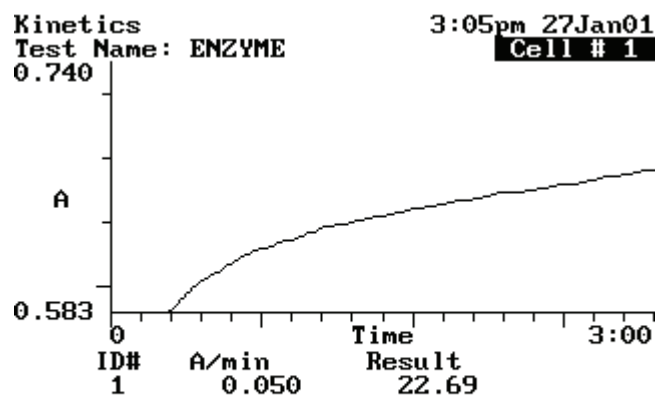

| | | | |
|--|---------|------------|----------------|
| | Tabular | Edit Graph | Measure Sample |
|--|---------|------------|----------------|

To switch between tabular and graphical displays, press **Graph/Tabular**.

On a graphical display you can press **Edit Graph** and then press **Cursor** to move the cursor line from one position to another on the plot. As the cursor moves, the rate and result values indicate the values for the point where the cursor is located.

Recalling and Recalculating Graphical Kinetics Results

The Kinetics application lets you view and manipulate results in graphical or tabular form. When your results are displayed, you can modify the range (start and stop time) and the instrument recalculates the reaction rate.

When working with graphical kinetics results, you need to press **Edit Graph** before you can rescale and recalculate.

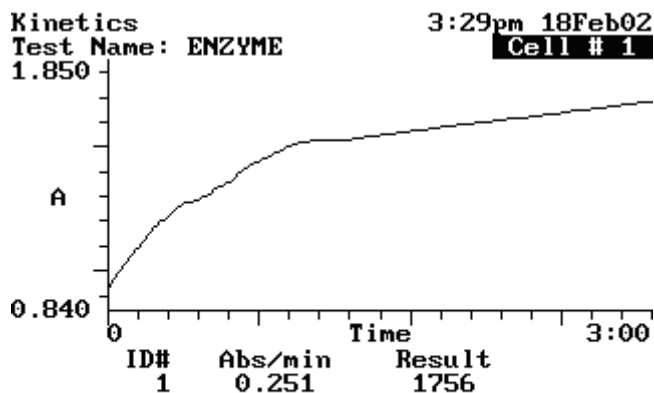

| Cursor | Manual Scale | Auto Scale | Save Data |
|--------|--------------|------------|-----------|
| | | | |

You can modify the scale of your kinetics data plot automatically or manually. When you select **Auto Scale**, the instrument automatically scales the X- and Y-axes so all the data appears on the plot. When you select **Manual Scale**, you select specific minimum and maximum values for the X- and Y-axes. Whenever you modify the scale, the instrument recalculates and displays the new reaction rate and result.

The edit screen lets you:

- Use Auto Scale to change the scale, display the new graph and recalculate the results
- Use Manual Scale to change the scale, display the new graph and recalculate the results
- Use the cursor to select new minimum or maximum values for the X-axis and recalculate the results

❖ To use Auto Scale

With your kinetics data displayed on the Edit Graph screen, press **Auto Scale**.

The instrument adjusts the minimum and maximum values for the X- and Y-axes so all the data appears on the plot. The instrument also recalculates the results, using all the data, and displays them.

❖ To use Manual Scale

1. With your kinetics data displayed on the edit screen, press **Manual Scale** to display the manual scale options.

20 Kinetics

Recalling and Recalculating Graphical Kinetics Results

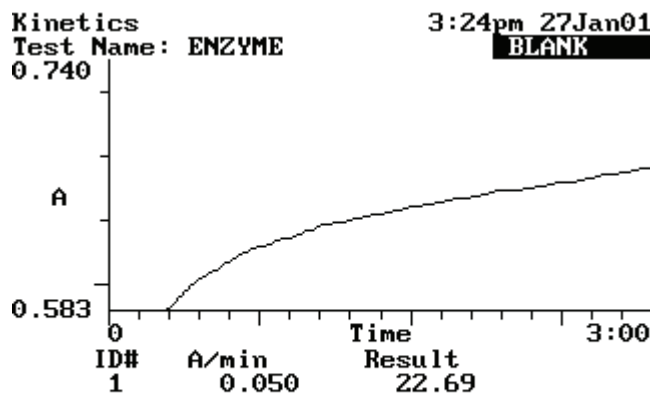

| Min Y | Max Y | Min X | Max X |
|-------|-------|-------|-------|
|-------|-------|-------|-------|

2. Enter the appropriate minimum or maximum value for the X- or Y-axis and press **Min Y**, **Max Y**, **Min X** or **Max X** to accept it.

The instrument redraws the plot using the entered minimum and maximum values and displays the recalculated rate and result.

3. Continue until you have entered all the values you want to change.

❖ To use the Cursor function

1. With your kinetics data displayed on the edit screen, press **Cursor** to display the cursor options.

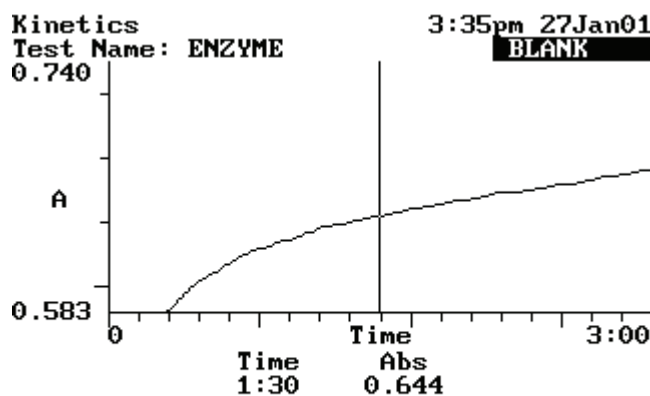

| Set Min X | Cursor ← | Cursor → | Set Max X |
|-----------|----------|----------|-----------|
|-----------|----------|----------|-----------|

2. Press **Cursor ←** or **Cursor →** to position the cursor line on the appropriate point on the graph.

The data for the selected point appears.

3. When the cursor line is in the correct position, press **Set Min X** or **Set Max X** to accept the selected point.

The instrument redraws the plot using the selected minimum and maximum values and displays the recalculated rate and result.

Rescaling and Recalculating Tabular Kinetics Results

When working with tabular kinetics results, you must press **Edit Data** before you can rescale and recalculate.

After collecting kinetics data, you can use all the data for the rate calculation or select specific start and end times. When you modify the start and end times or select all the data, the instrument recalculates and displays the new reaction rate and result.

The edit screen lets you:

- Use all the data to recalculate the results
- Select specific start and end times for the rate calculation and recalculate the results

```

Kinetics                               12:57 30Jan01
Test Name: KINETICS                     Cell # 1
-----
HH:MM:SS  Abs      Delta    Lin
-----
-> 0:00    0.417    -----  ---
   0:10    0.471    0.054    ---
   0:20    0.510    0.039    L
   0:30    0.534    0.024    L
   0:40    0.550    0.016    L
   0:50    0.559    0.010    L
   1:00    0.568    0.008    L
   1:10    0.574    0.007    L

      ID#   min/Abs   Result
      1     0.000     0.013

Press ↑ or ↓ for more data...
Use all data | Graph | Start Time | End Time
  
```

❖ To use all the data to calculate the reaction rate

With your table of kinetics data displayed on the edit screen, press **Use All Data**.

The instrument calculates and displays the rate.

❖ To select specific start and end times for the rate calculation

1. With your kinetics data displayed on the edit screen, highlight the appropriate data point in the table.
2. Press **Start Time** or **End Time** to display the recalculated rate and result.

20 Kinetics

Rescaling and Recalculating Tabular Kinetics Results

Performance Verification

Performance Verification lets you check the performance of your instrument with these tests:

- Wavelength Accuracy - Internal
- Wavelength Accuracy - Standard
- Wavelength Repeatability
- Resolution
- Photometric Accuracy
- Noise
- Stray Light
- Internal Printer Test

Run the appropriate tests regularly and maintain a log of results to help document the reliability of the instrument and indicate potential performance issues.

Note If a printer is installed and turned on, the instrument automatically prints test results. You can also press **Print** to print another copy of the results.

Accessing the Performance Verification Tests

❖ To access the Performance Verification tests

1. Press **Tests**.
2. Highlight **Performance Verification** and press **Enter**.

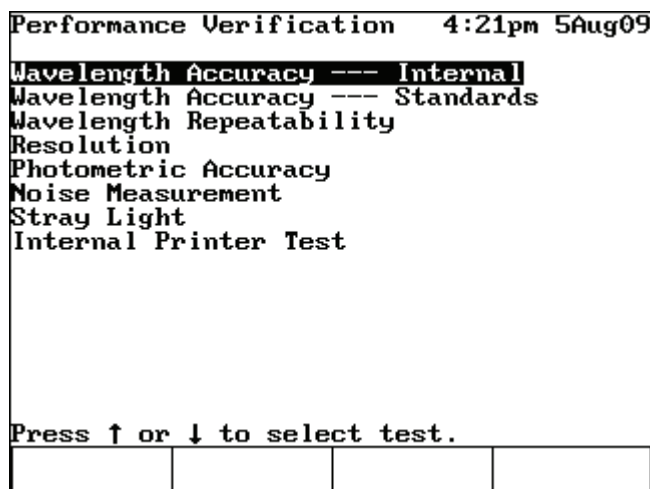

Troubleshooting Checklist

If a Performance Verification test fails, follow the instructions below to diagnose common problems.

If a test continues to fail after you have tried all these recommendations, follow the troubleshooting list for the test being run (included with the description of each test).

Make sure:

- You follow the instructions for the test properly.
- Filters and standards are clean.
- The sample compartment door is closed during the test.
- The sample compartment is clear of obstructions.
- The cell holder assembly is installed properly. If the 6-Position Cell Holder is installed, run the test once with the sample compartment door open to verify that the 6-Position Cell Holder is moving smoothly.
- No problems are indicated by the power-on diagnostics after you turn the instrument power OFF and then ON.
- The lamp is ON.
- The lamp compartment is clear of obstructions.

WARNING Do not open the lamp compartment unless the instrument power is OFF.

WARNING Do not turn the instrument power ON unless the lamp compartment is closed.

Wavelength Accuracy - Internal

This test locates the peaks of the internal xenon lamp and displays the expected and measured wavelengths for the peaks.

A xenon lamp has strong, fundamental lines at 229 nm, 529 nm and 883 nm. These lines are an essential property of xenon and serve as a fundamental standard.

When running the internal standard test, remember that:

- The wavelengths and tolerance values are preset and cannot be changed.
- The cell holder should be empty.

❖ To run the Wavelength Accuracy - Internal test

1. Highlight **Wavelength Accuracy - Internal** and press **Enter**.
2. Press **Start Test**.

The results indicate pass or fail for each wavelength.

| Performance Verification | | 16:13 2Mar07 | |
|--|------------------|----------------|---------------|
| Wavelength Accuracy --- Internal | | | |
| Expected nm | Tolerance ±nm | Measured nm | Result |
| 247.5 | ± 1 | 248.0 | Pass |
| 529.0 | ± 1 | 529.3 | Pass |
| 824.2 | ± 1 | 824.4 | Pass |
| Make sure the Blank position is empty. Press Start Test | | | |
| | | | Start Test |

If the test fails, follow these guidelines:

- Repeat the test twice to verify that the test is failing consistently.
- Contact technical support for more troubleshooting advice.

Wavelength Accuracy - Standard

This test measures the absorbance of a wavelength accuracy standard and compares the location of the peaks with precisely known values at up to five wavelengths. By default, wavelength accuracy tests are performed in absorbance mode; however, this test may also be performed in %T mode. Typical wavelengths and tolerances are included in the firmware, but these values can be changed to match the calibration certificate included with your standards.

When running the Wavelength Accuracy test, remember:

- You need Wavelength Accuracy standards designed to measure the wavelength accuracy at the specified wavelengths.
- Use an empty cell holder as the blank.
- Measure the standards in the order they are listed on the test screen.
- You can measure the wavelength standard at only five wavelengths.

❖ **To run the Wavelength Accuracy - Standards test**

Highlight **Wavelength Accuracy - Standards** and press **Enter**.

Performance Validation 13:33 1Feb02
Wavelength Accuracy --- Standards

| Expected nm | Tolerance ±nm | Measured nm | Result |
|----------------|------------------|----------------|--------|
| 399.0 | ± 2 | | |
| 525.0 | ± 2 | | |

Place Standard 1 in position 1

Press **Start Test**

or

Press **ESC** to save test

| | | | |
|--|-------------------|----------------------|-----------------------|
| | Add nm | Delete nm | Start Test |
|--|-------------------|----------------------|-----------------------|

❖ **To add a wavelength**

1. Press **Add nm** and enter the wavelength value in the **Entry** field.
2. Press **Add nm** again to add the wavelength to the list.
3. Enter the tolerance for the entered wavelength in the **Entry** field.
4. Press **Enter**.

❖ **To delete a wavelength**

1. Highlight the appropriate wavelength.
2. Press **Delete nm**.

❖ **To run the test**

1. Verify that the wavelengths and tolerances are set correctly.
2. Press **Start Test**.

The results indicate pass or fail for each wavelength.

If the test fails, follow these guidelines:

- Repeat the test twice to verify that the test is failing consistently.
- Make sure the target and tolerance values you entered for the calibrated wavelength are the same as the values on the calibration certificate for the standard.

Wavelength Repeatability

This test measures the ability of the spectrophotometer to return to an identical wavelength in a repeatable manner. The test uses the internal xenon lamp.

A xenon lamp has a strong, fundamental line 529 nm. This line is an essential property of xenon and serves as a fundamental standard.

When running the internal standard test, remember that:

- The wavelength and tolerance values are preset and cannot be changed.
- The cell holder should be empty.

❖ To run the Wavelength Repeatability test

1. Highlight **Wavelength Repeatability** and press **Enter**.
2. Press **Start Test**.

The results indicate pass or fail for each wavelength.

| Performance Verification | | 16:33 2Mar07 | |
|--|---------|--------------|---------------|
| Wavelength Repeatability | | | |
| Minimum | Maximum | Peak-to-Peak | Result |
| 529.2 | 529.3 | 0.1 | Pass |
| Make sure the Blank position is empty. Press Start Test | | | |
| | | | Start Test |

If the test fails, follow these guidelines:

- Repeat the test twice to verify that the test is failing consistently.
- Contact technical support for more troubleshooting advice.

Resolution

This test measures the ability of the spectrophotometer to resolve adjacent features in a spectrum. The test is performed using a 0.02% (v/v) solution of toluene in hexane and requires a hexane blank.

When running the internal standard test, remember that the wavelengths and tolerance values are preset and cannot be changed.

❖ To run the Resolution test

1. Highlight **Resolution** and press **Enter**.

Ensure that hexane is in the blank position and toluene in hexane is in cell 1.

| Performance Verification | | 16:37 2Mar07 | |
|------------------------------------|---------|--------------|------------|
| Resolution | | | |
| Maximum | Minimum | Ratio | Result |
| 0.100 | 0.037 | 2.672 | Pass |
| Place Hexane in the Blank position | | | |
| Place Toluene in Hexane in Cell 1 | | | |
| Press Start Test | | | |
| | | | Start Test |

2. Press **Start Test**.

The results indicate pass or fail for each wavelength.

If the test fails, follow these guidelines:

- Repeat the test twice to verify that the test is failing consistently.
- Contact technical support for more troubleshooting advice.

Photometric Accuracy

This test measures the absorbance (or %T) of a set of standards and compares the results with specified tolerances. The wavelength absorbencies and tolerances are preset, but you should change them to the values on the calibration certificate included with your standards.

Note You can display the tolerances for this test in either absorbance or %Transmittance.

When running the Photometric Accuracy test, remember:

- You need Photometric Accuracy standards calibrated to known absorbance values at specified wavelengths.
- Measure the standards in the order they are listed on the test screen.
- You can use one to five standards.

❖ **To display the Photometric Accuracy screen**

1. Highlight **Photometric Accuracy**.
2. Press **Enter**.

| Performance Verification | | 16:46 2Mar07 | | | |
|--|-------|--------------|------------|------------|--------|
| Photometric Accuracy | | | | | |
| # | nm | Expected %T | Tol. ±%T | Meas. %T | Result |
| 1 | 590.0 | 50.000 | ± 1.200 | | |
| 2 | 590.0 | 10.000 | ± 1.200 | | |
| Place Standards 1 - 2 in positions 1 - 2 | | | | | |
| Change to Abs | | Add Std | Delete Std | Start Test | |

Selecting the Mode

To switch between absorbance and %Transmittance, press **Change to %T** (or **Change to ABS**) until the appropriate mode appears.

Adding Standards

You will need to set three values whenever you add a standard: the wavelength, the absorbance (or %Transmittance) and the tolerance value.

❖ **To add a standard**

1. Press **Add Std** and enter the wavelength value in the **Entry** field.
2. Press **Enter** or **Add nm** to add the wavelength to the list.
3. Enter the absorbance or %T value for the entered wavelength in the **Entry** field.
4. Press **Enter**.
5. Enter the tolerance for the entered wavelength in the **Entry** field.
6. Press **Enter**.

The test screen displays the values you just entered for that standard.

7. Press **Start Test** to begin the measurement or **Press Esc** to save the test.

Deleting Standards

❖ **To delete a standard**

1. Highlight the appropriate standard.
2. Press **Delete Std.**

Running the Test

In the Photometric Accuracy screen, make sure the wavelengths, absorbance (or %T) values and tolerances are set correctly.

❖ **To run the Photometric Accuracy test**

Press **Start Test**.

The results indicate pass or fail for each wavelength.

Performance Validation 11:44 15Feb02
Photometric Accuracy

| # | nm | Expected %T | Tol. ±%T | Meas. %T | Result |
|---|-------|----------------|-------------|-------------|--------|
| 1 | 590.0 | 10.1 | ± 1.2 | 10.1 | Pass |
| 2 | 590.0 | 9.4 | ± 1.2 | 9.4 | Pass |

Place Standards 1 - 2 in positions 1 - 2

Press Start Test

or

Press ESC to save test

| | | | |
|--------------------------|--------------------|-----------------------|-----------------------|
| Change to Abs | Add Std | Delete Std | Start Test |
|--------------------------|--------------------|-----------------------|-----------------------|

If the test fails, follow these guidelines:

- Repeat the test twice to verify that the test is failing consistently.
- Follow the guidelines provided with the standard reference materials.
- For more troubleshooting advice contact our sales or service representative in your area or use the information at the beginning of this document to contact us.

Noise

This test measures the amount of noise at 340 nm.

All test parameters are determined by instrument specifications and cannot be changed by the user. When running the noise test, remember:

- Perform the 0A measurement with the cell holder empty. Optionally you can perform the 2A measurement with a 2A filter.

❖ To run the Noise Measurement test

1. Highlight **Noise Measurement**.
2. Press **Enter**.

```
Performance Validation      11:54 15Feb02
Noise Measurement
```

```
@0A      Peak-to-Peak  Meas.  Result
          Tolerance    Abs
230.0nm ≤0.002        0.000  Pass
340.0nm ≤0.001        0.000  Pass
```

```
@2A      Peak-to-Peak  Meas.  Result
          Tolerance    Abs
230.0nm ≤0.003        0.000  Pass
340.0nm ≤0.002        0.000  Pass
```

```
Make sure the Blank position is empty.
Place 2A filter in Cell Position 1
Press Start Test
```

| | | | |
|--|--|--|-----------------------|
| | | | Start Test |
|--|--|--|-----------------------|

3. With the Blank position empty, insert the 2A filter in position #1.

Ignore the test results at 2A if you do not have a filter installed in position #1.

4. Press **Start Test**.

The results of the test indicate pass or fail for each wavelength.

If the test fails, follow these guidelines:

- Repeat the test twice to verify that the test is failing consistently.
- Make sure the instrument is warmed up for at least 30 minutes, with the standby mode feature turned off.
- For more troubleshooting advice contact our sales or service representative in your area or use the information at the beginning of this document to contact us.

Stray Light

This test measures the stray light at selected wavelengths and compares the measurements with expected values. The wavelengths and expected values are preset and cannot be changed. Running the stray light test takes about 30 seconds.

When running the stray light test, remember:

- You need Stray Light standards designed to measure stray light at 220 nm, 340 nm and 400 nm (i.e., must have ≤ 0.1 %T at the wavelength of interest).
- Position B should be empty.
- Use position #1 for the 220 nm stray light standard (SRE 220 or equivalent).
- Use position #2 for the 340 nm stray light standard (SRE 340 or equivalent).
- Use position #3 for the 400 nm stray light standard (SRE 400 or equivalent).

Running the Test

In the Stray Light screen, make sure the wavelengths and tolerances are set correctly.

❖ To run the Stray Light test

1. Highlight **Stray Light**.
2. Press **Enter**.
3. Press **Start Test**.

The results indicate pass or fail for each wavelength.

If the test fails, follow these guidelines:

- Repeat the test twice to verify that the test is failing consistently.
- Make sure all the filters being used are specifically designed to measure stray light at the specific wavelengths.
- Verify that the filters are placed in the correct cell positions.
- For more troubleshooting advice contact our sales or service representative in your area or use the information at the beginning of this document to contact us.

Internal Printer Test

This test lets you verify that the internal printer is functional. To run the test, you will need to have an internal printer installed. Running the internal printer test takes no more than 20 seconds after you press Stop.

❖ **To run the Internal Printer test**

1. From the Utility screen, verify that the internal printer is installed properly and is selected.

If necessary, press **Utility** and then select the internal printer.

2. In the Performance Verification screen, highlight **Internal Printer Test**.

3. Press **Enter**.

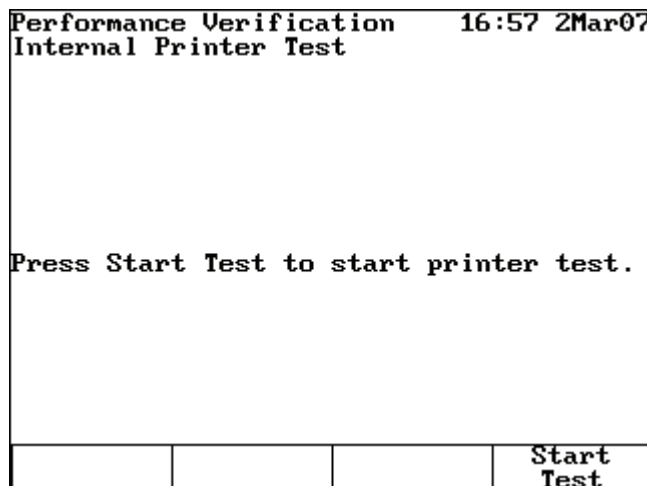

4. Press **Start Test**.

You can press **Stop Test** to stop the test.

The test print routine appears on the printed results.

If the test fails, follow these guidelines:

- Make sure the internal printer is the selected as the printer device on the Utility screen.
- Make sure the internal printer is installed correctly. (Return to the main screen and press **Enter**. If the paper does not move, the printer may not be installed correctly.)
- Make sure the thermal paper is threaded with the thermal side toward the printer head (the outside surface of the roll is the thermal surface).
- For more troubleshooting advice contact our sales or service representative in your area or use the information at the beginning of this document to contact us.

21 Performance Verification

Internal Printer Test

Maintenance

The spectrophotometer is durable and reliable, so routine maintenance is minimal. This section explains:

- [Routine Care](#)
- [Changing the Fuse](#)



WARNING Operating the instrument with the cover off exposes the operator to potentially dangerous voltages and ultraviolet (UV) radiation. Therefore, we recommend that only authorized service representatives perform procedures requiring removal of the instrument cover and replacement of electrical components. To protect both yourself and the instrument, be sure to contact an authorized service representative to perform any service procedure you do not feel comfortable performing.

Routine Care

Routine care for the spectrophotometer does not require a lot of time. To help minimize maintenance time and increase the life and performance of your instrument, please follow these guidelines:

- Always replace the dust cover when the instrument is not turned on to prevent dust from accumulating in and on the instrument.
- Do not use or store the instrument in a corrosive environment.
- Gently wipe the outside of the instrument, including the keypad, with a soft cloth to remove any dust or spills. Water, isopropyl alcohol and other common laboratory cleaning agents may be used if necessary.
- Always clean up spills as soon as they occur to prevent or minimize damage to the instrument. If concentrated acids or bases, or any hydrocarbon materials, are spilled on the instrument, clean up the affected area immediately.

Cleaning and Maintaining Cells

Carefully check the condition of the cuvettes and other cells used to measure samples. If they are chipped, cracked or scratched, it is important to discard the damaged cell(s) and replace them with new ones.

Ensuring your cuvettes are clean both inside and out is important to the quality of your results for two reasons: 1) contaminating material may absorb light resulting in falsely high absorbance readings; and 2) contaminants in the cell may react chemically with subsequent reagents or standards introduced into the cell.

Cleaning methods depend to some extent on the nature of the contaminating material. It is important to identify the residual material in the cell that needs to be removed. Refer to the following table for suggestions on cleaning methods, solvents and material.

| Solvents | Examples | Suggested Cleaning Methods |
|----------|-------------------------------------|---|
| Aqueous | Protein, Biologics, DNA | <ul style="list-style-type: none">• Warm water with detergent• Dilute nitric acid (<10%) rinse• Copious water rinse |
| Aqueous | Salt solutions | <ul style="list-style-type: none">• Dilute nitric acid (<10%) rinse• Copious water rinse |
| Aqueous | Basic solutions | <ul style="list-style-type: none">• Warm water with detergent• Dilute nitric acid (<10%) rinse• Copious water rinse |
| Organic | Hydrocarbons, small molecules, oils | <ul style="list-style-type: none">• Rinse with organic solvent• Warm water with detergent• Dilute nitric acid (<10%) rinse• Copious water rinse |
| Organic | Alcohol solutions | <ul style="list-style-type: none">• Rinse with similar alcohol, acetone, or other solvent• Copious water rinse |

| Solvents | Examples | Suggested Cleaning Methods |
|----------|-------------------------------------|--|
| Organic | Acidic solutions | <ul style="list-style-type: none"> • Rinse with organic solvent • Warm water with detergent • Dilute nitric acid (<10%) rinse • Copious water rinse |
| Organic | Hydrocarbons, small molecules, oils | <ul style="list-style-type: none"> • Rinse with organic solvent • Warm water with detergent • Dilute nitric acid (<10%) rinse • Copious water rinse |

IMPORTANT Keeping the cell clean is very important for long cell life.

- Never store cuvettes long term in a water or solvent bath between uses. If the solvent you are using dries, impurities in the water or solvent may be deposited on the inside of the cell, causing permanent damage.
- Use only lens cleaning tissue/paper or fine soft cloth to wipe optical surfaces. Most paper products (such as facial tissues, paper towels, etc.) contain wood fibers that can damage the cell material.
- At the end of the day, ensure that all cells are well cleaned and stored in a suitable container after drying.

| Term | Definition |
|---------------------|--|
| Dilute acid | Dilute nitric acid (<10%) |
| Acid | Hydrochloric (5M) acid or nitric acid (5M) (see the Note below) |
| Solvent rinse | Rinse with the solvent that was originally used to solvate your analyte |
| Copious water rinse | Use a pure water (e.g., deionized, distilled, RO) and rinse at least 10 times |
| Detergent | Use a neutral pH detergent (Triton® X-100), if available, to dilute acid wash; water rinse to remove residue |

Note Do not use 5M nitric acid on an Anti-reflection mirror coated cell.

IMPORTANT Using an ultrasonic cleaning bath for your cells is not recommended. Each bath generates a different frequency; therefore, if your bath operates at the resonant frequency of a cell, the cell will break. If a cell was cleaned in an ultrasonic bath, the warranty is void by the manufacturer.

IMPORTANT Do not dry cells in an oven.

Micro flowcells can be kept clean by:

- Flushing well with a solvent after use.
- Aspirating dilute acid, base, non-filming detergent or Clorox® through the cell in short bursts.
- Storing with distilled water in the cell.

Cleaning the Windows of the Sample Compartment

Do not use acetone or abrasive materials to clean the windows of the sample compartment. Instead, use a non-abrasive laboratory cleaning solution (such as a commercial cell cleaning solution), distilled water or alcohol.

Use the liquid and a soft, lint-free cloth to clean the windows. Do not apply too much pressure or the surface of the windows may be damaged. Be sure to remove all fingerprints.

Changing the Fuse

The fuse is located in the power entry module located at the center of the back panel of the instrument.

- 120 VAC, 2.5 A, Slo Blo
- 240 VAC, 1.25 A, Slo Blo (2 required)

IMPORTANT The instrument fuse must be replaced with the same type and rate.

IMPORTANT If the fuse fails repeatedly, it may indicate a serious problem with the instrument. Contact technical support as soon as possible.

❖ To change the fuse

1. Turn off and unplug the instrument from the wall outlet or power strip.
2. Position the instrument so you can access the power entry module on the back of the instrument.
3. Remove the power cord.
4. Insert a flat-blade screwdriver into the notch on the fuse cover and pry off the cover.

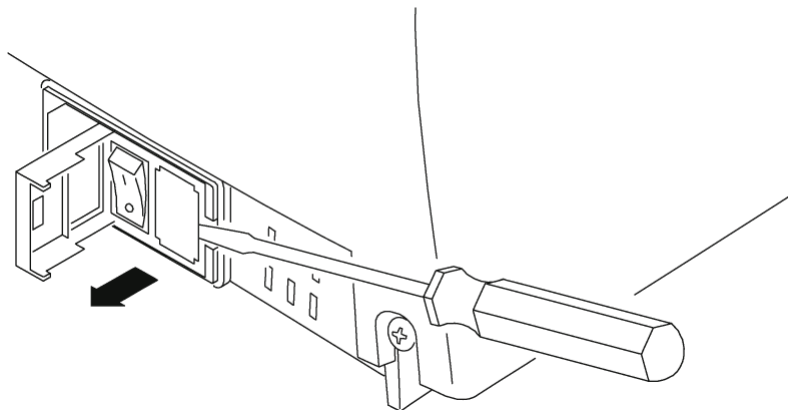

5. Use a flat-blade screwdriver to remove the fuse holder.

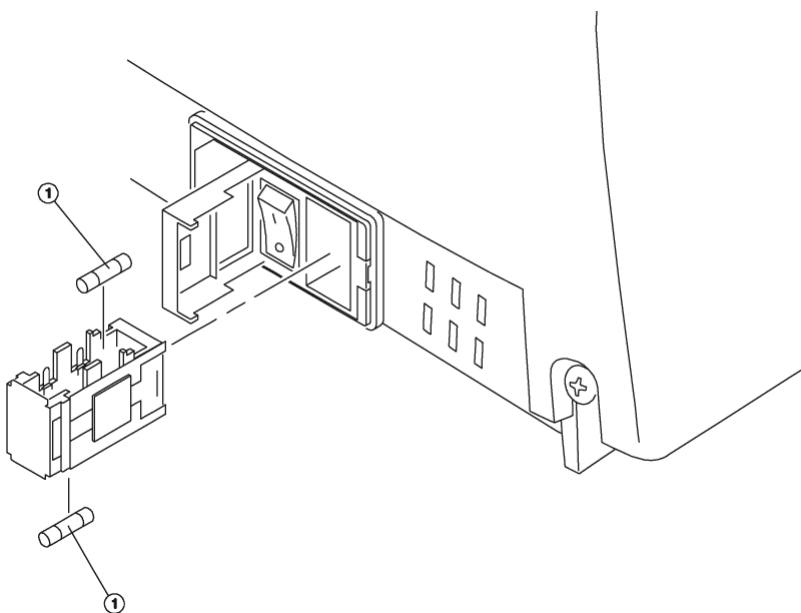

6. Unsnap both fuses to remove them.
7. Insert the new fuses, pushing them in so they snap into place.
8. Replace the fuse cover.
9. Replace the power cord.
10. Plug the instrument back in to the wall outlet or power strip and turn on the power.

Note If the fuse blows again, contact your distributor or technical support.

22 Maintenance

Changing the Fuse

Parameters

| Parameter | Description |
|---------------------|---|
| + - x ÷ | Enters math operators when in Calculator mode (Utility) |
| % Formamide | Enters percentage of formamide contained in the sample (Oligos tests) |
| % GC | Calculates percentage of GC pairs contained in the sample (Oligos tests) |
| %Mismatch | Enters the Mismatch value to calculate T _m (Oligos tests) |
| % of lamp life used | Displays the estimated percentage of lamp life used (based on a typical lamp life of five years) (Utility) |
| 3-Pt Net | Lets you calculate peak height from the tangential baseline in the graph (Scanning) |
| Absorbance | Enters the absorbance value |
| Accept Name | Accepts the displayed Name entry (Test Name and Edit [Units]) |
| Add Character | Adds a highlighted character to the Name entry (Test Name and Edit [Units]) |
| Add nm | Lets you add a wavelength and factor to the list in Multiwavelength tests and some Performance Verification tests |
| Area | Lets you calculate area under the peak in the graph (Scanning) |
| AutoPrint | Turns the automatic printout on or off |
| Autoscale | Rescales the graph to the original ranges of the X- and Y-axes (Kinetics, Scanning) |
| Base Sequence | Sequence of bases contained in the sample (Oligos – calc factor tests) |

| Parameter | Description |
|--|--|
| Baseline Expiration | Enters the time when the baseline for scan tests will need to be collected again (Utility) |
| Beeper | Turns the audible signal for key presses on and off (Utility) |
| Calculation Baseline | Selects the zero baseline or the tangential baseline to calculate area under the peak in the graph (Scanning) |
| Calculator | Enables the calculator mode (Utility) |
| Cell Correction | Selects the option to automatically correct for variances in absorption between the cuvettes (all test types) |
| Cell Position # | Displays the position placed in the light path (only with auto turret) |
| Change Mode Change to Abs Change to %T | Switches measurement modes (Basic A-%T-C and some Performance Verification tests) |
| Collect Baseline | Starts the collection of the baseline (Scanning only) |
| Concentration | Sets the concentration value |
| Conc of Standard | Displays the entered concentration value (Adv A-%T-C) |
| Correction Mode | Selects the mode for cell correction (Discrete nms or Scan) |
| Cursor | Goes to Cursor tracking mode to view data points in the graph (Kinetics, Scanning) |
| Cursor → ← Cursor | Moves the cursor right or left on the graph and displays the data of each point (Kinetics, Scanning) |
| Curve Fit | Selects the type of line fit calculation (Standard Curve tests) |
| Data File Name | Allows entry of a name for the data file when AutoSave = ON |
| Date Cell Correction | Displays the date when cell correction data on cuvettes was last collected |
| Date Standards Measured | Displays the date when standards were last measured with this instrument (Standard Curve tests) |

| Parameter | Description |
|---------------------|---|
| Date/Time Setup | Enters the current date and time settings for the instrument (Utility) |
| Delay Time | Enters the time from Test Initiation to first measurement; allows for sample equilibration (ADV. A-%T-C and Kinetics) |
| Delete Character | Deletes the last character of Name entry (Test Name and Edit [Units]) |
| Delete File | Deletes a test or data file from the Stored Tests Directory (Utility) |
| Delete Name | Deletes the entire name to allow a new entry (Test Name and Edit [Units]) |
| Delete nm | Removes a wavelength and factor from the list (Multiwavelength and some Performance Verification tests) |
| Diluent Volume | Enters the volume of diluent added before measurement (Dilution Multiplier in some Bio Tests) |
| Dilution Multiplier | Displays the factor used to correct for sample dilution |
| Display Activity | Indicates whether results should include protein concentration |
| DNA $\epsilon(260)$ | Calculates the extinction coefficient |
| DNA Factor | Enter the factor to calculate DNA concentration (DNA Bio Tests) |
| Edit | Lets you change a wavelength or factor in the list (Multiwavelength and some Performance Verification tests) |
| Edit Curve | Lets you manipulate the graph (Kinetics) |
| Edit Data | Lets you select a portion of the data in a table for recalculation of a result (Kinetics and Scanning) |
| Edit Graph | Lets you manipulate the graph (Scanning) |
| Edit Scale | Lets you change the graph axis scales and view individual data points (Scanning) |

| Parameter | Description |
|--------------------------|--|
| Factor | Enters a factor to convert a datum to a result Abs x Factor 1 = Concentration Result Abs/min x Factor 2 = Kinetics Result Can be entered or calculated from concentration and absorbance values in ADV A-%T-C |
| Factor 1 | Enters a factor to convert a datum to a result Abs(WL1) x Factor = Result (Abs Ratio, Abs Diff, Multiwavelength tests) |
| Factor 2 | Enters a factor to convert a datum to a result Abs(WL2) x Factor = Result (Abs Ratio, Abs Diff, Multiwavelength tests) |
| Factor 3-31 | Enters a factor to convert a datum to a result Abs (WL3-31) x Factor = Result (Multiwavelength tests) |
| Graph | Displays the graph of collected data (Kinetics, Scanning) |
| ID # | Enters the numeric identifier for measurement; autoincrements during the test until turned off (set to 0) |
| Instrument Serial Number | Displays the serial number of the instrument (Utility) |
| Intercept | Enters where the line crosses the Y-axis (Abs where conc=0) |
| Interval | Enters the wavelength range between data points (Scanning tests only) |
| Interval Time | Enters the time between repeated readings (Kinetics only) |

| Parameter | Description | | | | | | | | | | | | | | | | | | | | | | | | | | | | |
|--------------------------------------|--|------------|-----------|------------|-----------|---|----|----|-----|---|----|----|-----|---|-----|-----|---|---|-----|-----|---|---|-----|-----|---|---|-----|-----|---|
| Linearity Value | <p>Enters a linearity value (Kinetics only)</p> <p>To help determine the linearity of the reaction during the measurement, the instrument offers a linearity parameter. This is the difference between the changes in the absorbance of two measurements as shown in the following example:</p> <table border="1"> <thead> <tr> <th>Time</th> <th>Abs</th> <th>ΔA</th> <th>Linearity</th> </tr> </thead> <tbody> <tr> <td>1</td> <td>.1</td> <td>--</td> <td>---</td> </tr> <tr> <td>2</td> <td>.2</td> <td>.1</td> <td>---</td> </tr> <tr> <td>3</td> <td>.29</td> <td>.09</td> <td>P</td> </tr> <tr> <td>4</td> <td>.38</td> <td>.09</td> <td>P</td> </tr> <tr> <td>5</td> <td>.46</td> <td>.08</td> <td>P</td> </tr> <tr> <td>6</td> <td>.52</td> <td>.06</td> <td>F</td> </tr> </tbody> </table> <p>Linearity is the ΔA between ΔA calculations.</p> <p>P=Pass and F=Fail</p> | Time | Abs | ΔA | Linearity | 1 | .1 | -- | --- | 2 | .2 | .1 | --- | 3 | .29 | .09 | P | 4 | .38 | .09 | P | 5 | .46 | .08 | P | 6 | .52 | .06 | F |
| Time | Abs | ΔA | Linearity | | | | | | | | | | | | | | | | | | | | | | | | | | |
| 1 | .1 | -- | --- | | | | | | | | | | | | | | | | | | | | | | | | | | |
| 2 | .2 | .1 | --- | | | | | | | | | | | | | | | | | | | | | | | | | | |
| 3 | .29 | .09 | P | | | | | | | | | | | | | | | | | | | | | | | | | | |
| 4 | .38 | .09 | P | | | | | | | | | | | | | | | | | | | | | | | | | | |
| 5 | .46 | .08 | P | | | | | | | | | | | | | | | | | | | | | | | | | | |
| 6 | .52 | .06 | F | | | | | | | | | | | | | | | | | | | | | | | | | | |
| Load Test | Loads the highlighted test from the Stored Tests Directory into active memory and sets the instrument to the test parameters (Utility) | | | | | | | | | | | | | | | | | | | | | | | | | | | | |
| Lock/Unlock | Used to protect stored tests from accidental deletion or alteration; asks for a password to allow the user to lock or unlock the file (Utility) | | | | | | | | | | | | | | | | | | | | | | | | | | | | |
| Low/High Limits | Enters the lowest and highest acceptable results, outside of which the result is flagged as “Low” or “High” (Adv. A-%T-C, Std Curve, Abs Ratio, Abs Diff, Kinetics, 3-Pt Net and some Bio Tests) | | | | | | | | | | | | | | | | | | | | | | | | | | | | |
| Math | Accesses manipulation functions of the graph (Scanning) | | | | | | | | | | | | | | | | | | | | | | | | | | | | |
| Measure Blank (as function key) | Initiates measurement of the blank | | | | | | | | | | | | | | | | | | | | | | | | | | | | |
| Measure Blank (as test parameter) | <p>Selects the frequency of zeroing the instrument</p> <p>Once or Every Reading (Kinetics)</p> | | | | | | | | | | | | | | | | | | | | | | | | | | | | |

| Parameter | Description |
|----------------------------|---|
| Measurement Mode | Selects the type of photometric data reported for a measurement (Abs, %T, Conc) (in A-%T-C, Kinetics, Scanning, Multiwavelength) |
| Measure Samples | Initiates measurement of samples |
| Max, X | Enters a maximum X-value to manually rescale the graph (Kinetics, Scanning) |
| Max, Y | Enters a maximum Y-value to manually rescale the graph (Kinetics, Scanning) |
| Min, X | Enters a minimum X-value to manually rescale the graph (Kinetics, Scanning) |
| Min, Y | Enters a minimum Y-value to manually rescale the graph (Kinetics, Scanning) |
| Molarity of cation | Enters the molarity of Na ⁺ in the incubation mixture (T _m calculation in Oligos tests) |
| Next Cursor | Selects a cursor point in functions using more than one cursor setting: Scan-Area and Scan-3-Pt Net calculations in the graph (Scanning) |
| Number of bases | Enters the number of bases in the oligonucleotide (Oligos tests) |
| Number of Matched Cuvettes | Enters the number of cuvettes that will be run in the Correction Program (maximum of 5) |
| Number of Samples | Enters the number of samples to be measured in the test (Not available in Kinetics or Scanning) |
| Number of Standards | Enters the number of standards to be measured for the standard curve |
| Printer | Selects the output mode (internal, RS-232, Parallel) (Utility) |
| Printout Contrast | Lets you improve visibility of internal printer hardcopy by changing the darkness of the print (Utility) |
| Protein Factor | Enters the factor to calculate Protein concentration (DNA Bio Tests) |
| Ref. Wavelength | Enters a reference wavelength value; for each reported measurement, measures the analytical wavelength and reference wavelength. Reported measurement = Abs@Analytical WL - Abs@Reference WL |
| Ref. Wavelength Correction | Turns reference wavelength correction on or off |

| Parameter | Description |
|-------------------|---|
| Run Corr. | Initiates the collection of cuvette data for cell correction |
| Run Standard | Goes to the Standards entry screen |
| Run Test | Goes to the data collection screen (all tests) |
| Sample Positioner | Selects the type of Positioner 1 Cell = no movement (zeros and measures sample in same position) (Not available in Kinetics and Scanning) Manual 6 = cell changer moved by buttons (always zeros on position B, then returns to set position to start measurement) (Not available in Kinetics and Scanning) Auto 3 = turret auto moved - B, 2, 4 (always zeros on position B, then goes to position 2 to start measurement) (Not available in Kinetics and Scanning) Auto 6 = turret auto moved - B,1,2,3,4,5 (always zeros on position B, then goes to position 1 to start measurement) |
| Sample Volume | Enters the total volume of sample (under Dilution Multiplier in some Bio Tests) |
| Save Test | Saves all parameters of the current test in internal memory for later recall (all tests) |
| Scan speed | Selects the speed (nm/min) for a scan – Slow, Medium, Fast (Scanning tests only) |
| Screen Contrast | Lets you improve visibility of the display by changing the contrast between the background and text (Utility) |
| Select Test | Tags the highlighted test name with “>” to include the test in the SmartStart menu (Utility Stored Tests Directory) |
| Set Max. X | Sets the cursor position in the graph as the minimum X and the maximum X values for recalculating rate (Kinetics) |
| Set Min. X | |
| Set nms | Lets you enter and edit the wavelength and factor values |
| Set Options | Selects the factor entry or the baseline to calculate area under the peak in the graph (Scanning) |
| Setup correction | Initiates the procedure to collect the data necessary to correct for absorbance differences between cuvettes (all test types) |

| Parameter | Description |
|-------------------------|--|
| Slope | Enters $\Delta\text{Abs}/\Delta\text{Concentration}$ value (Standard Curve test type) |
| Smoothing | Turns data smoothing on and off (Scanning) |
| Software Revision | Displays the version of firmware in the instrument (Utility) |
| SRE tolerance | Acceptable minimum stray light |
| Standard Concentrations | Enters the concentration of standards used to generate the standard curve for the test |
| Standby | Selects the time since the last keystroke or instrument activity; powers down the unit to save lamp life (Utility) |
| Start wavelength | Enters the beginning wavelength for a scan (Scanning tests only) |
| Statistics | Turns stats on or off; if ON, calculates the average and Std Dev of results; Statistics registers are cleared when Statistics = OFF and/or when instrument is OFF, and/or when test parameters are changed, and/or when test is saved (or resaved) (in all test types except Kinetics, Scanning, Multiwavelength) |
| Std Concentration | Enters the concentration of the analyte in the standard solution |
| Stop wavelength | Enters the ending wavelength for a scan (Scanning tests only) |
| Stored Tests Directory | Displays the list of tests stored in the instrument (Utility) |
| Tabular | Displays the list of collected data (Kinetics, Scanning) |
| Test Name | Lets the user enter an alphanumeric name (maximum of 16 characters) for the test; the name will be included on the data printout and, if the test is saved, will be displayed in the Utility Test Directory screen (available in all tests) |
| Tm value | Calculates the melting temperature (Oligos tests) |
| Total Run Time | Enters the time from the Run initiation to the end of the test; equals Delay Time + Interval Times + Measurement Times (Kinetics) |

| Parameter | Description |
|---------------|---|
| Units | Selects or creates units labels for results (all stored tests except Abs Ratio, Scanning, Cell Growth) |
| Unselect Test | Removes the ">" tag of the highlighted test name to remove the test from the SmartStart menu (Utility Stored Tests Directory) |
| Wavelength | Enters values for the analytical wavelengths |

Calculations for Software

| Calculation | Calculation(s) | Graphs |
|-------------------------------------|---|--------|
| Standard Curves | | |
| Partial sums | $SX = \sum x_i$ $SY = \sum y_i$ $SXX = \sum x_i^2$ $SYY = \sum y_i^2$ $SXY = \sum x_i y_i$ $SQX = \sum (x_i - \bar{x})^2 = N * SXX - SX^2$ $SQY = \sum (y_i - \bar{y})^2 = N * SYY - SY^2$ $SSXY = \sum (x_i - \bar{x})(y_i - \bar{y}) = N * SXY - SX * SY$ <p>Where: x_i = Concentration of i^{th} standard y_i = Absorbance of i^{th} standard N = number of standards</p> | |
| Linear regression (general case) | $A = A(c)$ <p>Where: A = absorbance c = concentration A(c) is defined by an equation of the form:</p> $A(c) = a_4 c^4 + a_3 c^3 + a_2 c^2 + a_1 c + a_0$ <p>Where: a_0 = Y-axis intercept $a_1 \dots a_4$ = coefficients</p> <p>(The coefficients are computed using the least squares method.)</p> | |

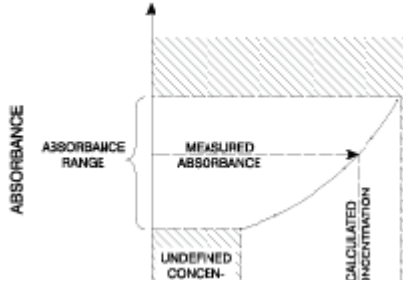
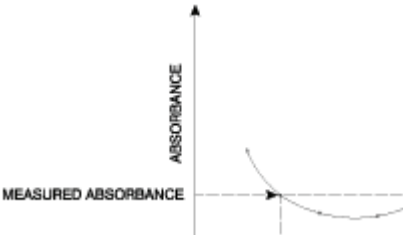
| Calculation | Calculation(s) | Graphs |
|--------------------------------|--|---|
| Linear regression through zero | $A = a_1 \cdot (c)$ <p>Where: A = absorbance c = concentration a_1 = slope</p> <p>The slope is calculated as:</p> $a_1 = SXY/SXX$ <p>This model requires:</p> <ul style="list-style-type: none"> • Slope is not equal to zero or infinity • At least one standard data point with concentration >0 • The absorbance of the 0 concentration blank = 0A | |
| Segmented model | <p>The segmented model requires:</p> <ul style="list-style-type: none"> • Data for at least two standard data points with different concentrations and absorbances • Slopes of all segments must be ascending (positive) or descending (negative) | |
| Validity of standard curves | $A(c_1) > A(c_2) \text{ for all } c_1 > c_2$ <p>or</p> $A(c_1) < A(c_2) \text{ for all } c_1 > c_2$ <p>Where: A = absorbance c_1, c_2 = concentration</p> |  <p>Valid nonlinear standard curve</p> |
| | <p>If this is not the case, there will be more than one solution within the specified domain, and the message “Curve cannot be used to determine sample concentrations – it may produce ambiguous results” will appear when the curve is viewed.</p> |  <p>Invalid nonlinear standard curve</p> |

| Calculation | Calculation(s) | Graphs |
|---|---|--------|
| Statistics (Linear regression general case) | $\sigma = \sqrt{\frac{\sum (y_i - \bar{y}_i)^2}{N - n - 1}}$ <p>Where: N = Degree of polynomial</p> $r = \frac{ SSXY }{\sqrt{SQX * SQY}}$ <p>The calculation for the correlation coefficient applies only to first order linear regression curves (first degree polynomials).</p> | |
| Linear regression through zero model | $\sigma = \sqrt{\frac{SYY - (a_1 * SXY)}{N - 1}}$ | |
| Absorbance ratio | $\frac{Abs\lambda_1}{Abs\lambda_2} \quad \text{or} \quad \frac{Abs\lambda_1 - Abs_{ref}}{Abs\lambda_2 - Abs_{ref}}$ | |
| Absorbance Difference | <p>Result =</p> $Abs\lambda_1 * factor \ 1 - Abs\lambda_2 * factor \ 2$ <p>or</p> $(Abs\lambda_1 - Abs\lambda_{ref}) * factor \ 1 - (Abs\lambda_2 - Abs\lambda_{ref}) * factor \ 2$ | |

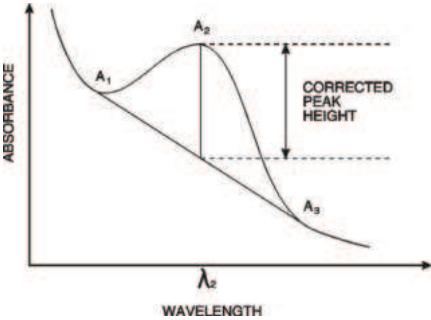
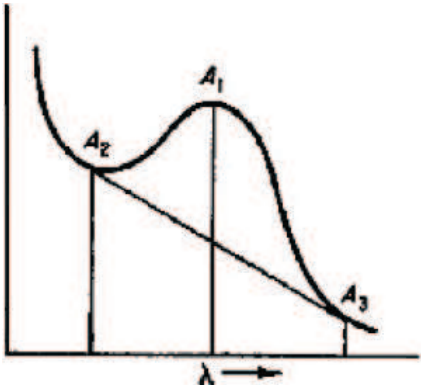
| Calculation | Calculation(s) | Graphs |
|-------------------------------|--|--|
| 3-Point Net | Baseline corrected absorbance = $A_2 - \left(A_3 + \left([A_1 - A_2] * \frac{\lambda_3 - \lambda_2}{\lambda_3 - \lambda_1} \right) \right)$ |  <p>3-Point Net Absorbance sample curve</p> |
| 3-Point Net (ASTM E169-04) | Baseline corrected absorbance = $A_1 - \left(A_3 + \left([A_2 - A_3] * \frac{\lambda_3 - \lambda_1}{\lambda_3 - \lambda_2} \right) \right)$ |  |

Calculations for Oligo Calculator

| Calculation | Entry Parameters | Formula | Displayed Units |
|--|--|--|--|
| # of bases | Repetitive sequence of A, T (or U), G and C | Count total number of bases entered. | Length = # of bases |
| %GC content | Use AT (U) GC sequence entered above | $\%GC = \frac{\# \text{ of } (G + C) \text{ bases} \times 100}{\text{total \# of AT (or U)GC}}$ | Percentage |
| Molecular weight | # units A, # units T, # units G, # units C # units U | If entry does not include U: $MW = (312.2 \times A) + (303.2 \times T) + (329.2 \times G) + (289.2 \times C) + 18.02$ If entry does include U: $MW = (329.2 \times A) + (306.2 \times U) + (345.2 \times G) + (305.2 \times C) + 18.02$ | Molecular weight = x Da/M |
| Absorptivity ϵ (260) | # units A, # units T, # units G, # units C # units U | If entry does not include U: $\epsilon_{260} = (15,200 \times A) + (8,400 \times T) + (12,010 \times G) + (7,050 \times C)$ If entry does include U: $\epsilon_{260} = (15,200 \times A) + (9,900 \times U) + (12,010 \times G) + (7,050 \times C)$ | Extinction coefficient = $M^{-1}cm^{-1}$ |
| Conversion Factor | N/A | Molecular Weight x 10^3 Extinction Coefficient | $\mu\text{g/mL}$ |
| Calculation of T_m : Oligos up to 20 bases in length | # units A, # units T, # units G, # units C | $T_m = 2(A + T) + (G + C)$ | $^{\circ}\text{C}$ |

25 Calculations for Oligo Calculator

| Calculation | Entry Parameters | Formula | Displayed Units |
|---|---|---|---------------------|
| Calculation of T_m : DNA-DNA hybrids | <ul style="list-style-type: none"> # units A, # units T # units G, # units C M = molarity of cation Fraction GC = fraction of G and C % form = % formamide in the sample L = # of base pairs P = % mismatching | $T_m = 81.5C + 16.6 \log(\text{Na}^+) / (1 + 0.7(\text{Na}^+) + 0.51(\%GC) - 500/L - P - 0.63(\% \text{ formamide}))$ | °C |
| Calculation of T_m : DNA-RNA hybrids | <ul style="list-style-type: none"> # units A, # units T # units G, # units C M = molarity of cation Fraction GC = fraction of G and C % form = % formamide in the sample L = # of base pairs P = % mismatching | $T_m = 67^\circ\text{C} + 16.6 \log(\text{Na}^+) / (1 + 0.7(\text{Na}^+) + 0.8(\%GC) - 500/L - P - 0.5(\% \text{ formamide}))$ | °C |
| Calculation of T_m : RNA-RNA hybrids | <ul style="list-style-type: none"> # units A, # units T # units G, # units C M = molarity of cation Fraction GC = fraction of G and C % form = % formamide in the sample L = # of base pairs P = % mismatching | $T_m = 78^\circ\text{C} + 16.6 \log(\text{Na}^+) / (1 + 0.7(\text{Na}^+) + 0.7(\%GC) - 500/L - P - 0.35(\% \text{ formamide}))$ | °C |
| Conversion from | <p>$\mu\text{g}/\text{ml}$ and molecular weight from Oligo (calc factor) test</p> | $\text{pmol}/\mu\text{L} = \frac{\mu\text{g} / \text{mL} \times 1000}{\text{DNA Mol. Wt.}}$ | pmol/ μL |