

SPECTROPHOTOMETER CM-3600A

INSTRUCTION MANUAL



Before using this instrument,
please read this manual.



KONICA MINOLTA



LAB Online Exhibition



Safety Symbols

The following symbols are used in this manual or CM-3600A to prevent accidents which may occur as a result of incorrect use of the instrument.



Denotes an instruction regarding a safety warning or note.
Read the instruction carefully to ensure safe and correct use.



Denotes an instruction regarding the risk of electric shock.
Read the instruction carefully to ensure safe and correct use.



Denotes an instruction regarding the risk of fire.
Read the instruction carefully to ensure safe and correct use.



Denotes a prohibited action.
This action must never be performed.



Denotes an instruction.
This instruction must be strictly adhered to.



Denotes a prohibited action.
Never disassemble the instrument.



Denotes an instruction.
Be sure to disconnect the AC adapter from the AC outlet.



This symbol indicates A.C.



This symbol indicates D.C.



This symbol indicates class II protection against electric shock.

Trademarks











- Windows® is a registered trademark of Microsoft Corporation in the United States and other countries.







Notes on this Manual

- Copying or reproduction of all or part of the contents of this manual without KONICA MINOLTA's permission is strictly prohibited.
- The contents of this manual are subject to change without prior notice.
- Every effort has been made in the preparation of this manual to ensure the accuracy of its contents. However, should you have any questions or find any errors, please contact your retailer or a KONICA MINOLTA-authorized service facility.
- KONICA MINOLTA will not accept any responsibility for consequences arising from the use of the instrument.

Safety Precautions

To ensure correct use of this instrument, read the following points carefully and adhere to them. After you have read this manual, keep it in a safe place where it can be referred to anytime a question arises.

 WARNING		(Failure to adhere to the following points may result in death or serious injury.)
 <p>Do not use the instrument in places where flammable or combustible gases (gasoline, etc.) are present. Doing so may cause a fire.</p>	 <p>Do not disassemble or modify the instrument or the AC adapter. Doing so may cause a fire or electric shock.</p>	
 <p>Always use the AC adapter supplied as a standard accessory or the optional AC adapter, and connect it to an AC outlet of the rated voltage and frequency. If an AC adapter other than those specified by KONICA MINOLTA is used, it may result in damage to the unit, fire or electric shock.</p>	 <p>Take special care not to allow liquid or metal objects to enter the instrument. Doing so may cause a fire or electric shock. Should liquid or metal objects enter the instrument, turn the power OFF immediately, disconnect the AC adapter plug from the AC outlet, and contact the nearest Konica Minolta-authorized service facility.</p>	
 <p>If the instrument will not be used for a long time, disconnect the AC adapter plug from the AC outlet. Accumulated dirt or water on the prongs of the AC adapter's plug may cause a fire and should be removed.</p>	 <p>The instrument should not be operated if it is damaged or the AC adapter is damaged, or if smoke or odd smells occur. Doing so may cause a fire. In such situations, turn the power OFF immediately, disconnect the AC adapter plug from the AC outlet and contact the nearest Konica Minolta-authorized service facility.</p>	
 <p>Do not forcibly bend, twist, or pull the AC adapter power cable. Do not scratch or alter the power cable or place heavy objects on it. Doing so may damage the power cable and cause a fire or electric shock.</p>	 <p>Always hold the plug itself when disconnecting the AC adapter plug from the AC outlet. Pulling on the power cable may damage it and cause a fire or electric shock.</p>	
 <p>Insert the power plug fully and securely. Incomplete inserting may cause fire or electric shock.</p>	 <p>Do not insert or disconnect the AC adapter plug from an AC outlet with wet hands. Doing so may cause electric shock.</p>	

 CAUTION		(Failing to adhere to the following points may result in injury or damage to the instrument or other property.)
 <p>Do not perform measurement with the specimen measuring port directed towards your eyes. Doing so may damage your eyes.</p>	 <p>Do not place the instrument on an unstable or sloping surface. Doing so may result in its falling or overturning, causing injury. Be careful not to drop the instrument when carrying it.</p>	
 <p>Be careful not to get your hand caught in the openable section of the instrument. Doing so may result in injury.</p>	 <p>Make sure that the AC outlet is located near the instrument and that the AC adapter plug can be connected to and disconnected from the AC outlet easily.</p>	
	 <p>When cleaning, disconnect the power plug. Connecting may cause electric shock.</p>	

INTRODUCTION

This spectrophotometer is designed for spectral measurement of color and color differences in various industries. It can measure both reflected and transmitted color with high accuracy.

■ Packing Materials

General Packing Materials

Keep all packing materials (cardboard box, cushioning material, plastic bags, etc.) in a safe place. The CM-3600A is a precision measuring instrument. They can be used to protect the instrument from impact and vibration during shipment to Konica Minolta for maintenance. Should they be lost or damaged, contact the nearest Konica Minolta-authorized service facility.

Protective Cap for Sample Holder

The CM-3600A is delivered with no target mask attached. To protect the specimen measuring port, a protective cap is attached to the sample holder. This protective cap must be removed before using the CM-3600A. When you transport the CM-3600A to another place, the protective cap must be attached. Keep the protective cap in a safe place.

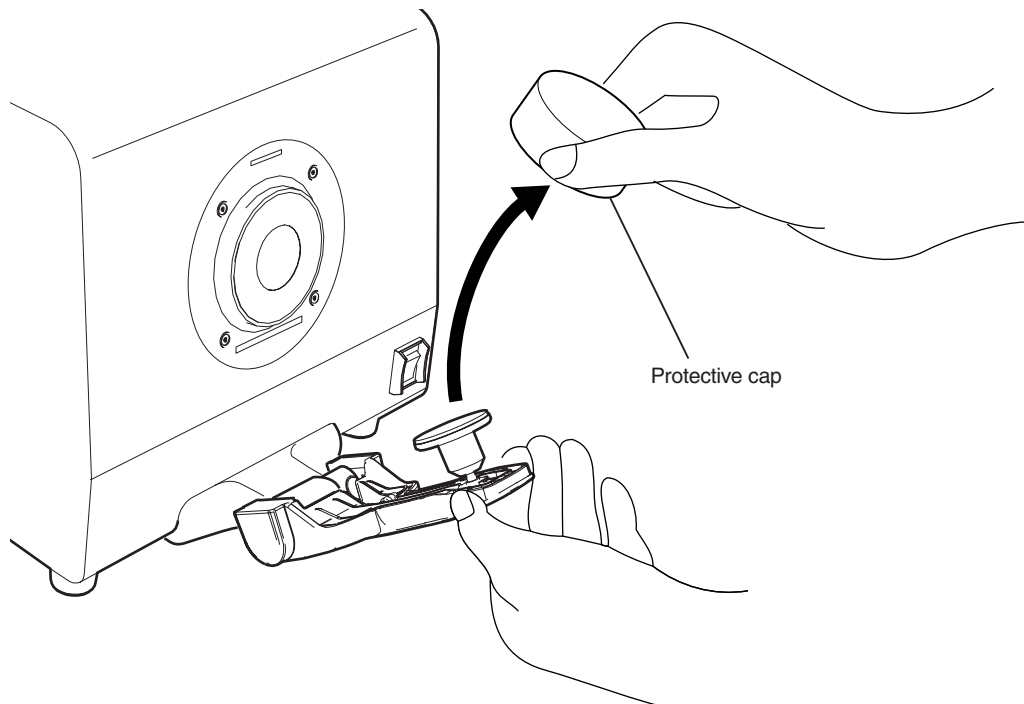

■ Notes on Use

Be sure to use this instrument properly. Use of this instrument in ways other than those specified in this manual may result in risk of injury, electric shock, instrument damage, or other problems.

Operating Environment

- Use the CM-3600A at an ambient temperature between 13°C and 33°C and relative humidity 80% or less (at 33°C) with no condensation. Be sure to use the instrument within this range. Do not use it in areas of rapid temperature changes.
- Do not leave the CM-3600A in direct sunlight or near sources of heat, such as stoves, etc. The internal temperature of the instrument may become much higher than the ambient temperature in such cases.
- Do not use the CM-3600A in areas where dust, cigarette smoke or chemical gases are present. Doing so may cause deterioration in performance or a breakdown.
- Do not use the CM-3600A near equipment which produces a strong magnetic field (such as speakers, etc.).
- The CM-3600A belongs to installation category I products (equipment which is powered by an AC adapter connected to commercially available power).
- The CM-3600A belongs to pollution degree 2 products (equipment which may cause temporary electrical hazards due to contamination or condensation or products which are used in such an environment).
- Do not use the CM-3600A at altitudes higher than 2,000 m.
- The CM-3600A and the AC adapter supplied as a standard accessory have been designed exclusively for indoor use. They should never be used outdoors because rain or other factors may damage the instrument.

Measurement

- Make sure no dirt or dust get into the specimen measuring port.
- When using the instrument for long periods of time, the measurement value may change depending on changes in the environment. Therefore, in order to achieve accurate measurements, we recommend that white calibration be done regularly using the White Calibration Plate.

White Calibration Plate

- The calibration data for the White Calibration Plate was measured at 23°C.
To achieve the highest accuracy when measuring absolute values (colorimetric values), calibration and measurement should be performed at 23°C.
- Do not allow the White Calibration Plate to get scratched or stained with such as fingerprints.
- Do not move the White Calibration Plate while it has been caught by the sample holder. Doing so may damage the White Calibration Plate.
- When the White Calibration Plate is not in use, be sure to close the cover so that the White Calibration Plate is not exposed to ambient light.

Target Mask

- Do not touch the Target Mask's inner surface (black-coated surface) by hand, scratch it or make it dirty.
- When not in use, Target Masks should be stored in the accessory case (CM-A215) so that they will not be exposed to ambient light.

Power Source

- Make sure that the power switch is set to OFF (" I ") when the CM-3600A is not in use.
- Always use the AC adapter supplied as a standard accessory (AC-A308) and connect it to an AC outlet of the rated voltage and frequency.
- Use an AC power supply of the rated supply voltage (within $\pm 10\%$).
- Do not connect the AC adapter to an overloaded electrical circuit. In addition, do not wrap or cover the AC adapter with cloth or other material while in use. Doing so may cause an electric shock or fire.

System

- Do not subject the CM-3600A to strong impact or vibration. Doing so may cause deterioration of performance or breakdown.
- The specimen measuring port and integrating sphere are extremely precise components, and great care should be taken to prevent them getting dirty or exposing them to impacts. When the CM-3600A is not in use, be sure to attach a target mask to the measuring port to prevent entry of foreign matter.
- The CM-3600A may cause interference if used near a television, radio, etc.
- Since the CM-3600A uses a microcomputer, external magnetic noise may cause malfunction. In this case, turn the power OFF, and wait 30 minutes, and then turn it ON again.

About Transmittance Measurement

- Do not spill a specimen or other liquid on the instrument. If any liquid is spilled on the instrument, wipe it off immediately with a soft, dry cloth.

■ Notes on Storage

- The CM-3600A should be stored at temperatures between 0°C and 40°C, and at a relative humidity of 80% or less (35°C) without condensation. Do not store the instrument in areas subject to high temperatures, high humidity, sudden changes in temperature, or where freezing or condensation may occur, because these circumstances may cause a breakdown. It is recommended to store the CM-3600A with a drying agent at a temperature around 20°C.
- Do not leave the CM-3600A inside a car such as in the trunk. Otherwise, the temperature and/or humidity may exceed the allowable range for storage during midsummer or midwinter, resulting in a breakdown.
- Keep the packing materials used for shipment and use them to transport the CM-3600A. This protects the instrument from sudden changes in temperature, vibration, and shock.
- Do not store the CM-3600A in areas where dust, cigarette smoke or chemical gases are present. Doing so may cause deterioration in performance or a breakdown.
- Entry of dust into the specimen measuring port will hinder accurate measurement. When the instrument is not in use, you must close the transmittance chamber cover and cover the instrument with the supplied Dust Cover to prevent the entry of dust into the integrating sphere.
- The White Calibration Plate may become discolored if left exposed to light. Therefore, make sure to close the cover when it is not in use so that the White Calibration Plate is not exposed to ambient light during storage.
- The Target Masks may discolor if they are left exposed to light. When they are not in use, keep them in a safe place to prevent exposure to light and to protect them from scratches and dust. And store them in the accessory case (CM-A215).
- Take care not to leave the CM-3600A for a long period of time with a target mask attached. The sample holder may stick to the target mask.
- Be sure to keep all packing materials (cardboard box, cushioning material, plastic bags, etc.). They can be used to protect the instrument during transportation to the service facility for maintenance (re-calibration etc.).

■ Notes on Cleaning

- If the CM-3600A becomes dirty, wipe it with a soft, clean dry cloth. Never use solvents such as thinner or benzene.
- If the White Calibration Plate becomes dirty, wipe it with a soft, clean dry cloth. If dirt is difficult to remove, wipe it off with a cloth dampened with commercially-available lens cleaning solution. Then remove the solution with a cloth dampened with water, and leave the plate to dry.
- If the inner surface (black-coated surface) of the Target Masks, or the inside of the integrating sphere, get dirty, contact a Konica Minolta-authorized service facility.
- Should the CM-3600A break down, do not try to disassemble and repair it by yourself. Contact a Konica Minolta-authorized service facility.

■ Disposal Method

- Make sure that the CM-3600A and its accessories and packing materials are either disposed of or recycled correctly in accordance with local laws and regulations.

CONTENTS

Safety Precautions	1
INTRODUCTION	2
Packing Materials	2
Notes on Use.....	3
Notes on Storage.....	5
Notes on Cleaning.....	5
Disposal Method.....	5
CONTENTS.....	6

Using the CM-3600A

Standard Accessories.....	8
Optional Accessories.....	9
System Diagram	10
Names and Functions of Parts.....	11
Measurement Procedure.....	12
Flow of Preparation and Measurement	12
Connecting a Personal Computer.....	13
Connecting the AC Adapter.....	14
Turning Power ON and OFF.....	15
Attaching a Target Mask.....	16
Notes on Use of Target Mask	16
Attaching the Zero Calibration Box	17
Notes on Use of Zero Calibration Box	17
Attaching the White Calibration Plate.	18
Notes on Use of White Calibration Plate	18
Updating White Calibration Data	18
Attaching the Transmittance Zero Calibration Plate (Optional Accessory) ...	19
Notes on Use of Transmittance Zero Calibration Plate	19
Performing 100% calibration	20
Setting up instrument for 100% calibration to air.. 20	
Setting up instrument for 100% calibration to water.....	20
Setting a Specimen	21
Removing the Sample Holder.....	21
Reflectance measurement	22
About opacity measurements.....	22
Transmittance measurements	23
About haze measurements.....	23

Cleaning the CM-3600A and Accessories....	24
Zero Calibration Box and White Calibration Plate	24
Target Mask.....	24
Inside Integrating Sphere	24
Receiving Window	24
Error Message.....	25
TROUBLESHOOTING GUIDE.....	27

Explanations

Illumination/Observation System.....	30
Measuring Reflected Colors	30
Measuring Transmitted Colors.....	30
Illumination and Measurement Areas ...	31
Target Mask.....	31
Measurement Area.....	31
System Configuration	31
Overview of Simultaneous Measurement of SCI/SCE.....	32
SCI/SCE SIMULTANEOUS MEASUREMENT	32
Fluorescent Measurement.....	33
WHEN FLUORESCENT CALIBRATION IS PERFORMED:.....	33
CALCULATING FLUORESCENT REFLECTANCE.....	33
WHEN FLUORESCENT CALIBRATION IS NOT PERFORMED	33
UV CUT LIGHT SOURCES.....	33
Dimensions	34
Specifications	35



Using the CM-3600A

Standard Accessories

White Calibration Plate **CM-A139**

Used to perform white calibration for measurement of reflectance and to perform measurement of transmittance. A CD-ROM containing white calibration data and software for writing the white calibration data are supplied with this accessory.

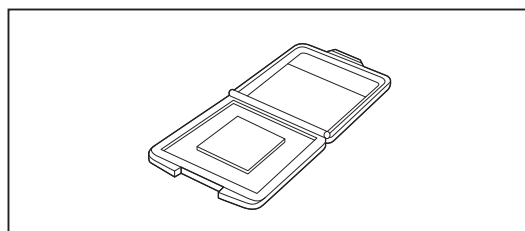

Target Mask **CM-A105** **CM-A106** **CM-A107**

Used to change the illumination area (measurement aperture) according to the specimen. Measurement and illumination (aperture area at specimen surface) areas for each target mask are as follows:

CM-A105 (LAV) : $\varnothing 25.4$ mm / $\varnothing 30$ mm

CM-A106 (MAV) : $\varnothing 8$ mm / $\varnothing 11$ mm

CM-A107 (SAV) : $\varnothing 4$ mm / $\varnothing 7$ mm

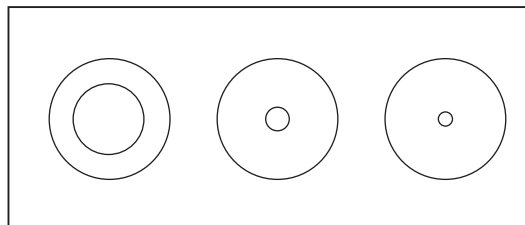

Zero Calibration Box **CM-A104**

Used to perform zero calibration for measurement of reflectance and to perform haze measurement at measurement of transmittance.

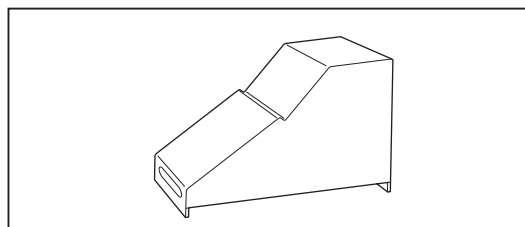

AC Adapter **AC-A308**

Used to supply power from an AC outlet to the CM-3600A.

Input: 100 to 240 V \sim 50/60 Hz

Output: 8 V --- 1.5 A

Plug design: \oplus \ominus Center-negative

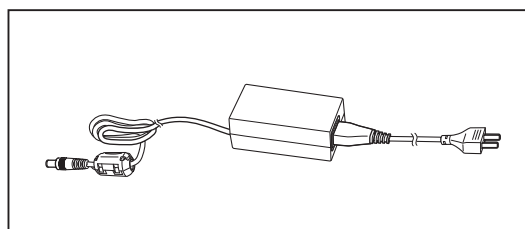

USB Cable (3 m) **IF-A21**

Used to connect the instrument to a personal computer (PC).

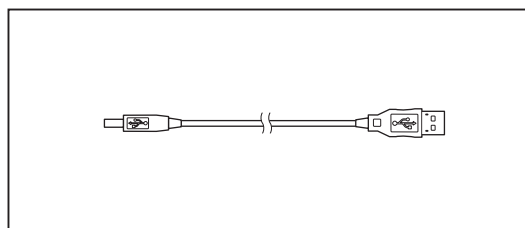

Accessory Case **CM-A215**

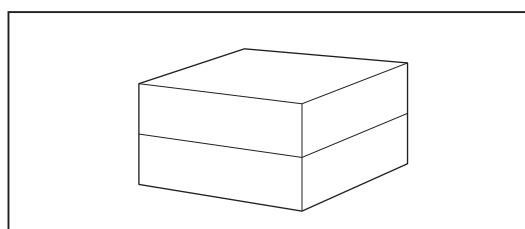

Dust Cover **CM-A110**

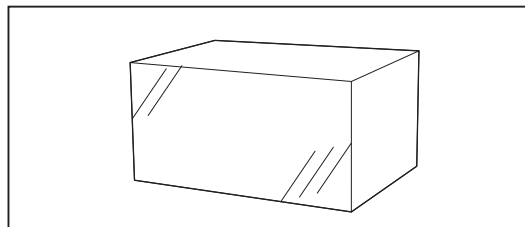

Optional Accessories

Software

SpectraMagic™ NX CM-S100w

This software provides various functions (e.g., data processing and file management) and allows the user to operate the CM-3600A using a personal computer.

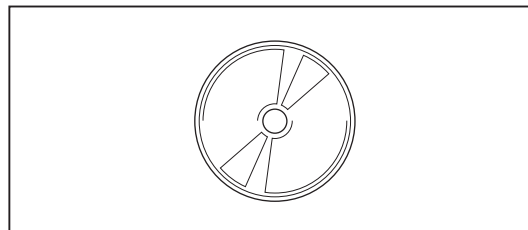

Transmittance Specimen Holder CM-A96

Used to hold the specimen for measurement of transmittance. It can hold specimens up to 22.5 mm (7/8 in.) thick.

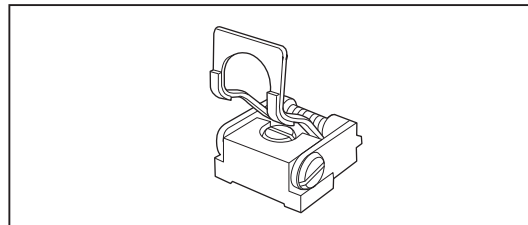

Plastic Cell

CM-A130 (optical path length 2mm)

CM-A131 (optical path length 10mm)

CM-A132 (optical path length 20mm)

This disposable plastic container is used to hold liquid specimens.

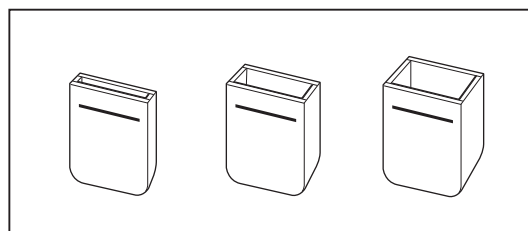

Cell

CM-A97 (optical path length 2mm)

CM-A98 (optical path length 10mm)

CM-A99 (optical path length 20mm)

This glass container is used to hold liquid specimens.

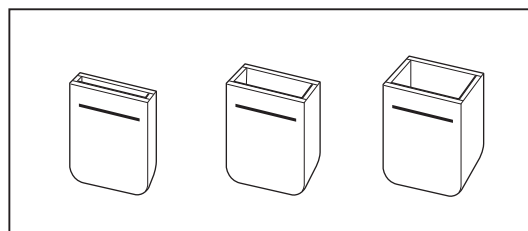

Transmittance Zero Calibration Plate CM-A100

Used when performing zero calibration for transmittance measurements.

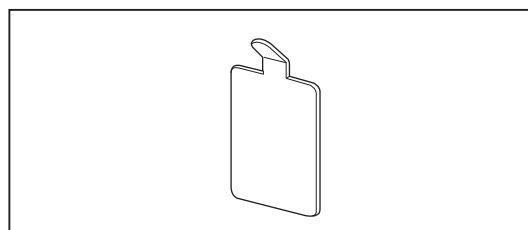

USB Cable (5 m) IF-A22

Used to connect the instrument to a personal computer (PC).

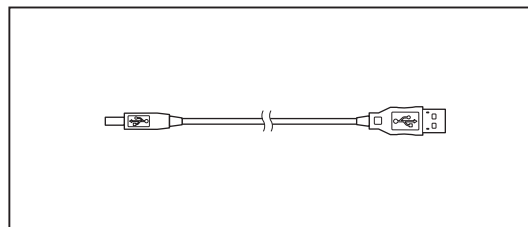

System Diagram

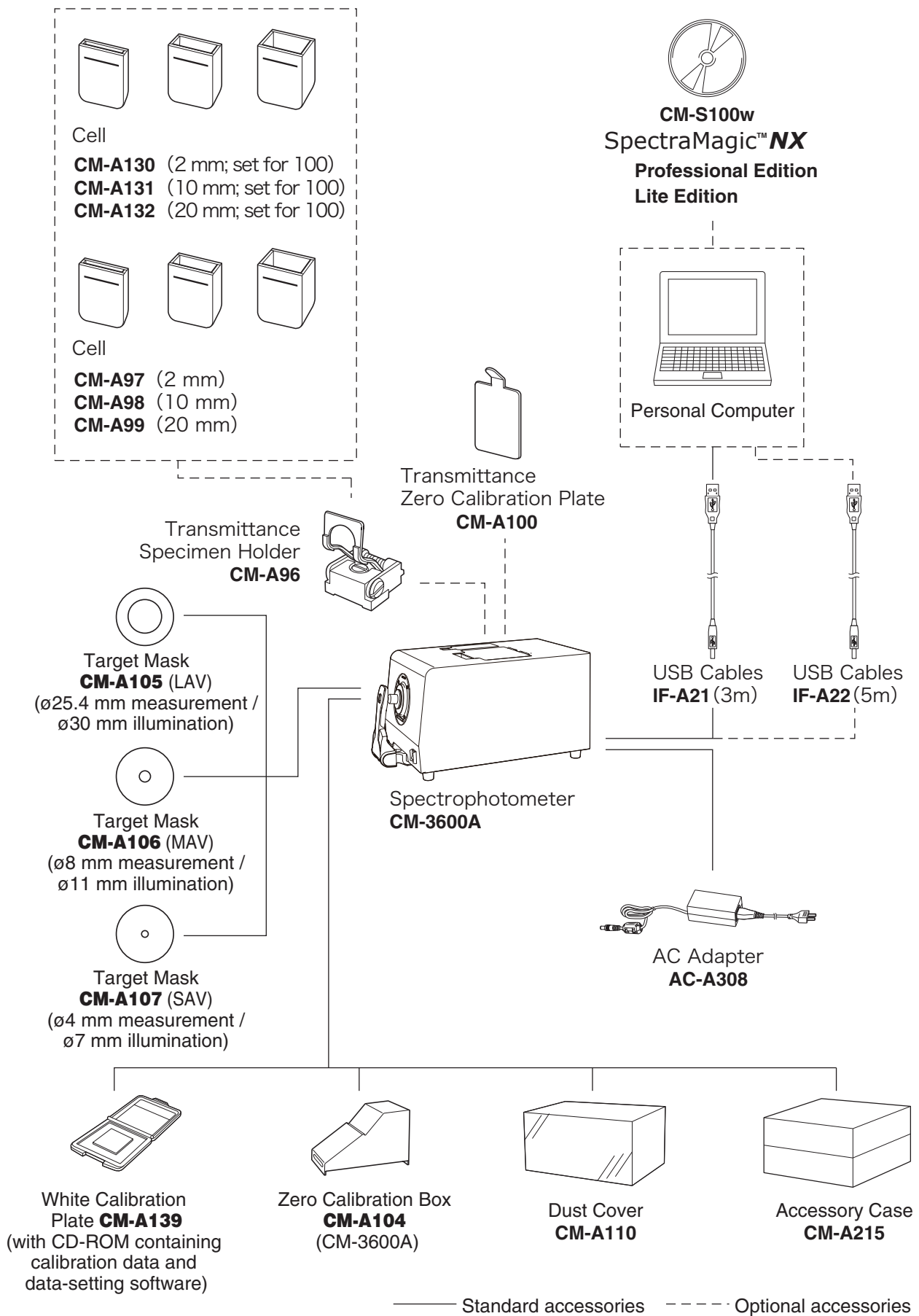

Names and Functions of Parts

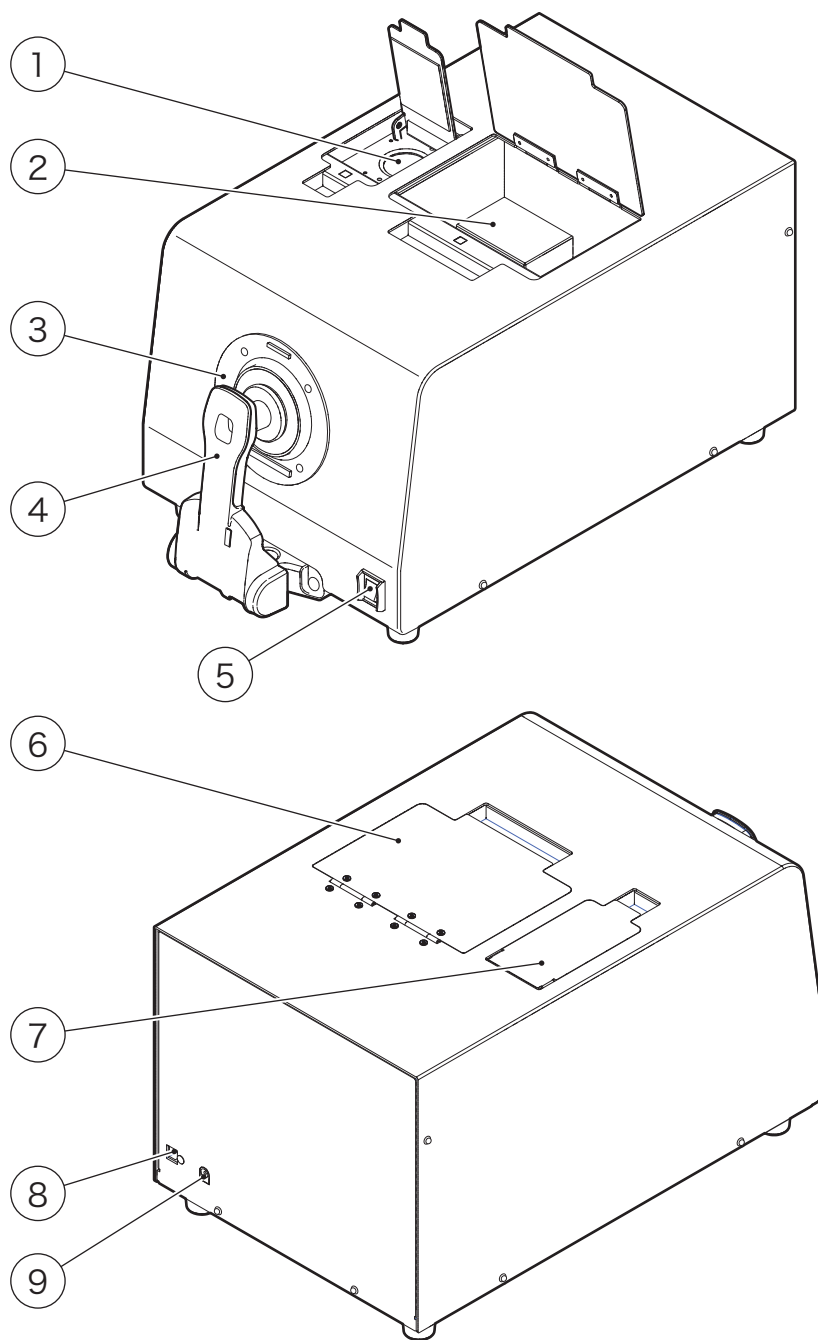

- ① ViewfinderUsed to locate the position of the specimen for measurement of reflectance.
- ② Transmittance chamberPlace the specimen in this chamber to perform measurement of transmittance.
- ③ Target maskSelect a suitable target mask (for $\varnothing 30$ mm (LAV), $\varnothing 11$ mm (MAV) and $\varnothing 7$ mm (SAV) illumination) according to the specimen and attach it to the CM-3600A.
- ④ Sample holder.....Used to hold the specimen, white calibration plate or zero calibration box.
- ⑤ Power switch.....Used to turn power ON and OFF.
- ⑥ Transmittance chamber cover ...Covers the transmittance chamber used for transmittance measurements.
- ⑦ Viewfinder coverOpen this cover to check the position of the specimen for measurement of reflectance.
- ⑧ USB connection terminal.....Used to connect the instrument to a PC with the supplied USB cable (IF-A21 or IF-A22).
- ⑨ AC adapter input socket.....Used to connect the AC adapter supplied with the CM-3600A.

Measurement Procedure

- This manual explains how to prepare the CM-3600A and how to set a specimen.
- The CM-3600A is controlled by a PC to perform measurements.
- For a description of measuring method using SpectraMagic™ NX (optional), refer to the SpectraMagic™ NX instruction manual.

■ Flow of Preparation and Measurement

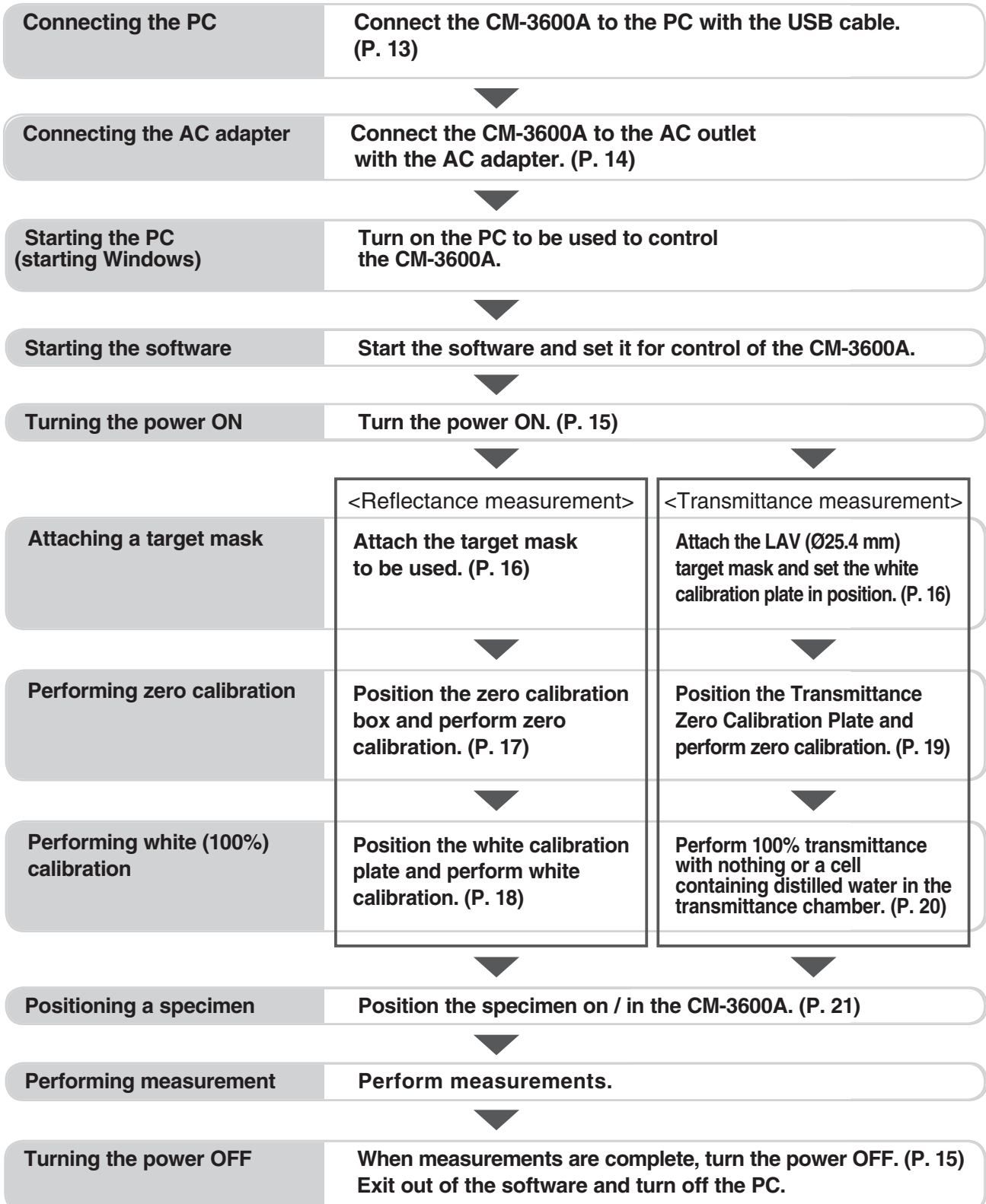

Connecting a Personal Computer

Connect the instrument to a PC with the supplied USB cable IF-A21 (3 m).

Memo

- To connect the instrument with a PC, it is recommended that you use software that enables connection and operation of the instrument (such as the optional Color Management Software SpectraMagic™ NX).
 - The USB communication port of the instrument conforms to USB 1.1.
- To connect the instrument to a PC, you need to install the USB driver dedicated to the CM-3600A. Install the USB driver supplied with the software that enables connection and operation of the instrument.
 - The instrument is not designed to be powered via the USB cable. You need to connect the AC adapter.
 - Make sure that the USB connector plug is oriented correctly and connected securely.
 - When connecting/disconnecting the USB cable, be sure to hold the connector plug. Do not pull on or forcibly bend the cable. Otherwise, wire breakage may result.
 - Make sure that the cable has sufficient length. Putting tension on the cable may cause connection failure or wire breakage.
 - To connect the USB cable connector, check the shape of the receptacle (connection terminal) and insert the connector fully until it is secured.

Operating Procedure

In general, a USB cable can be connected/disconnected while the instrument is turned ON; however, you need to turn OFF the instrument in the procedure below. See P. 14 for how to connect the AC adapter and P. 15 for how to switch the power on and off.

- 1. Turn OFF the instrument (Press the “○” side of the Power switch.).**

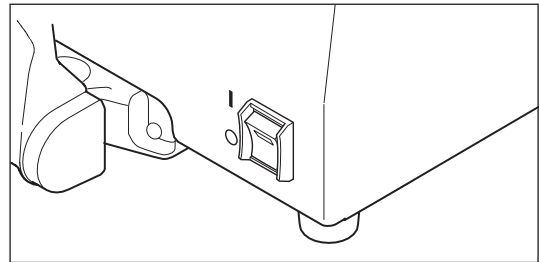

- 2. Connect the B connector of the USB cable to the USB connection terminal (B type) of the instrument.**

- Fully insert the connector and ensure secure connection.

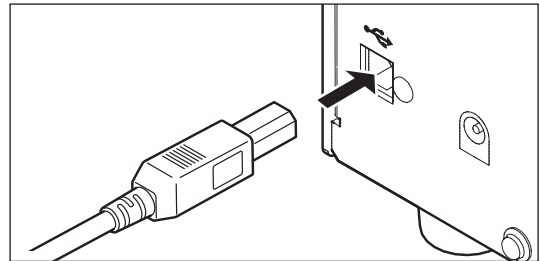

- 3. Connect the A connector of the USB cable to the USB port of the PC.**

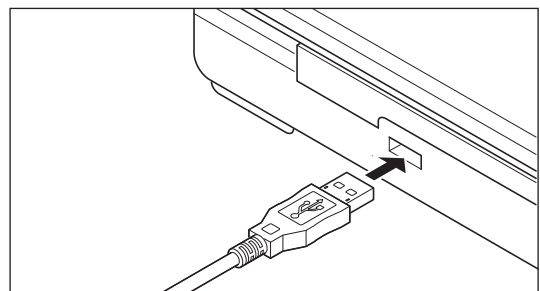

- 4. Connect the AC adapter and turn ON the instrument (Press the “I” side of the Power switch.).**

- When you are prompted to install the USB driver, specify the USB driver included with the software or the white calibration data CD and complete the installation.
- When using the optional Color Management Software SpectraMagic™ NX, refer to the SpectraMagic™ NX Installation Guide.
- After installation of the USB driver has finished, switch the instrument off for a few seconds and then switch it back on.

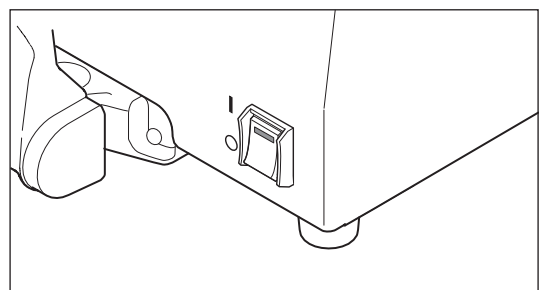

Connecting the AC Adapter



WARNING



Always use the AC adapter supplied as a standard accessory or specified replacement AC adapter with the CM-3600A, and connect it to an AC outlet of the rated voltage and frequency. Failure to do so may damage the CM3600A or the AC adapter, causing a fire or electric shock.



If the CM-3600A will not be used for a long time, disconnect the AC adapter from the AC outlet. Accumulated dirt or water on the prongs of the AC adapter's plug may cause a fire and should be removed.



Do not insert or disconnect the AC adapter with wet hands. Doing so may cause electric shock.



Insert the power plug fully and securely. Incomplete inserting may cause fire or electric shock.



Do not disassemble or modify the AC adapter. Doing so may cause a fire or electric shock.



Do not unplug or plug in the AC adapter with the instrument's power switch set to ON. Doing so may cause malfunction.

Connecting Procedure

- 1. Make sure that the power switches of both CM-3600A and host PC are set to OFF ("O").**

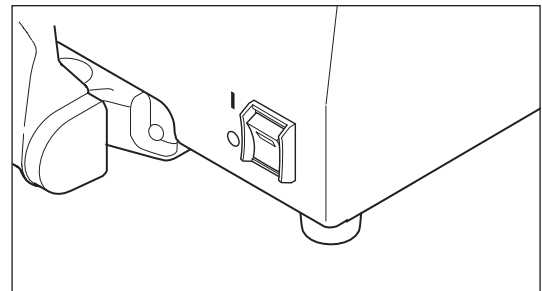

- 2. Insert the output plug of the AC adapter into the AC adapter input socket on the rear of the CM-3600A.**

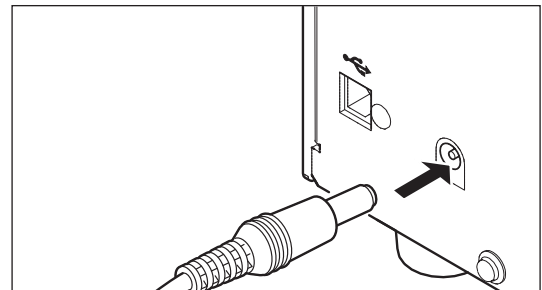

- 3. Insert the input plug of the AC adapter into an AC wall outlet.**

- The AC Adapter AC-A308 supplied as the standard accessory must be used.
- Before disconnecting the AC adapter, the power switch must be set to OFF ("O").

Turning Power ON and OFF



WARNING



The CM-3600A should not be operated if the CM-3600A or the AC adapter is damaged, or smoke or strange odors occur. Doing so may result in a fire. In such situations, turn the power OFF immediately, disconnect the AC adapter from the AC outlet, and contact the nearest Konica Minolta-authorized service facility.

Procedure

- 1. To turn the power ON and to light the lamp on the power switch, set the power switch to ON (" I ").**

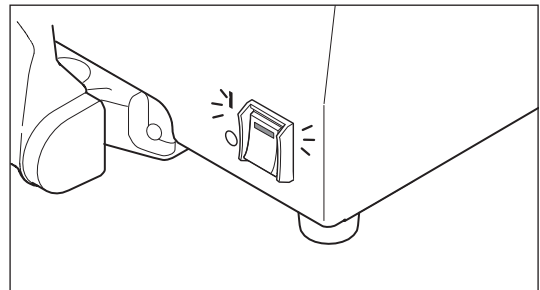

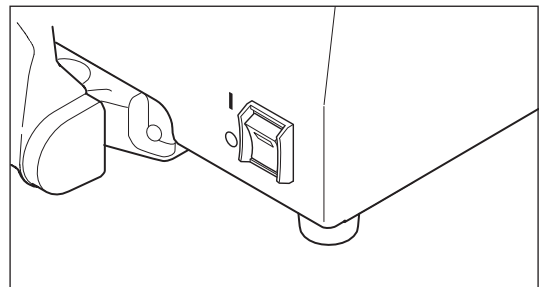

- 2. To turn the power OFF, set the power switch to OFF (" O ").**



Attaching a Target Mask

WARNING

-  Do not place the CM-3600A on an unstable or sloping surface. Doing so may result in its falling or overturning, causing injury. Take care not to drop the CM-3600A when carrying it.
-  Be careful around openings in the CM-3600A. Failure to do so may result in fingers being trapped causing injury.

The CM-3600A allows you to select a target mask from the following three types according to the specimen and your application.

Target mask

CM-A105 (for LAV $\varnothing 25.4\text{mm}$ measurements: illumination area: $\varnothing 30\text{mm}$)

CM-A106 (for MAV $\varnothing 8\text{mm}$ measurements: illumination area: $\varnothing 11\text{mm}$)

CM-A107 (for SAV $\varnothing 4\text{mm}$ measurements: illumination area: $\varnothing 7\text{mm}$)

Procedure

1. Pull the sample holder toward you and keep it open.

-  The sample holder will remain open when opened more than 70 degrees.

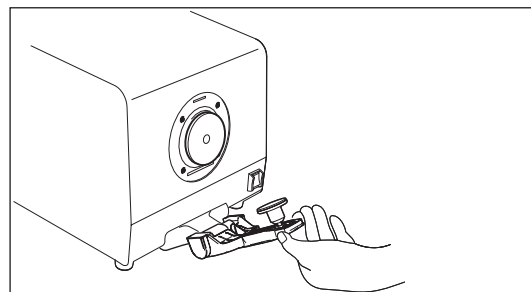

2. Remove the currently attached target mask by pulling it toward you.

- Memo** • The target mask is held on by magnets.

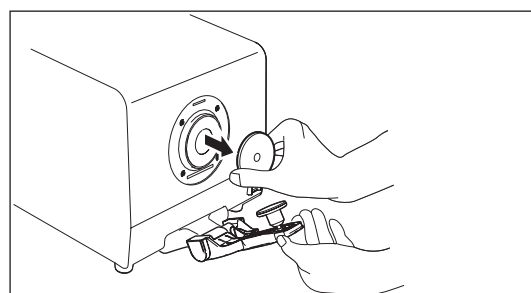



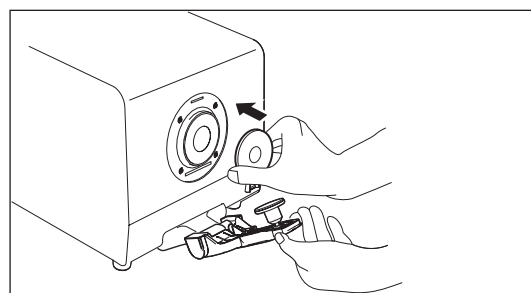

3. Take the desired target mask in your hand, and attach it to the CM-3600A. Make sure that it fits into the concave area around the integrating sphere opening.

- Memo** • When attaching a target mask, make sure that the black-coated side faces the CM-3600A.





4. Release the sample holder to close it.

■ Notes on Use of Target Mask

-  Take care not to scratch or make the inner surface (black-coated surface) of the target masks dirty with such as fingerprints.
-  The target masks may become discolored if left in areas exposed to light. Therefore, make sure that target masks which are currently not in use are kept inside the accessory case (CM-A215) to prevent exposure to light.
-  When not using the CM-3600A, attach one of the target masks or the protective cap to prevent dust entering the integrating sphere.
-  Take care not to leave the CM-3600A for a long period of time with a target mask attached. The sample holder may stick to the target mask.

Attaching the Zero Calibration Box

WARNING

-  Do not perform measurement with the specimen measuring port directed towards your face. Doing so may cause damage to your eyes .
-  Be careful around openings in the CM-3600A. Failure to do so may result in fingers being trapped causing injury.

The zero calibration box is used to perform zero calibration for measurement of reflectance and to perform haze measurement at measurement of transmittance.

- Make sure that there is nothing in the transmittance chamber.
- Before performing zero calibration, attach the target mask to be used for measurements.
- Before performing zero calibration, set the same measurement area, specular component (SCI/SCE), and UV light quantity as when performing zero calibration using the software. In the fluorescent measurement that does not require rigorous accuracy (that does not perform fluorescent calibration), perform measurement under the condition that the UV cut-off filter does not cover the xenon lamp (UV light quantity is 99.9).

Procedure

1. Pull the sample holder toward you and keep it open.

- The sample holder will remain open when opened more than 70 degrees.

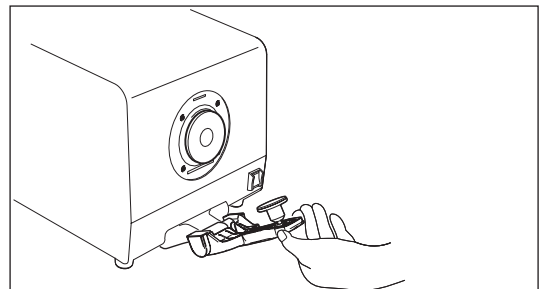

2. Fit the projections of the zero calibration box into the grooves on the CM-3600A and then close the sample holder to hold the box in place.

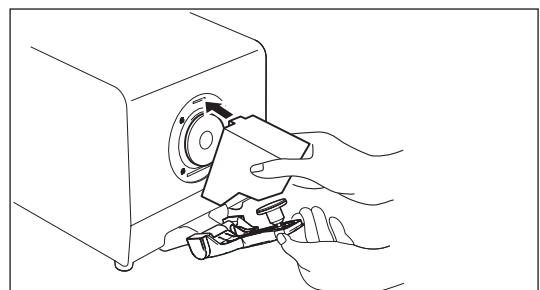



■ Notes on Use of Zero Calibration Box

- Take care not to scratch, touch, or make the inside of the zero calibration box dirty with such as fingerprints.
- If the inside of the zero calibration box gets dirty, wipe it with a soft, clean, dry cloth.
- If dirt is difficult to remove, dampen a cloth with commercially available lens cleaning liquid and wipe the zero calibration box. Then wipe off the liquid with a cloth dampened with water, and leave the box to dry.
- Should the inside of the zero calibration box get so dirty that it cannot be cleaned, replace the box with a new one.

Attaching the White Calibration Plate

CAUTION

-  Do not perform measurement with the specimen measuring port directed towards your face. Doing so may cause damage to your eyes .
-  Be careful around openings in the CM-3600A. Failure to do so may result in fingers being trapped causing injury.

The white calibration plate is used to perform white calibration for measurement of reflectance and to cover the reflectance measuring port when performing transmittance measurements (zero calibration, 100% calibration, measurement).

- Make sure that there is nothing in the transmittance chamber.
- Before performing white calibration, attach the target mask to be used for measurements.
- Before performing **white** calibration, set the same measurement area, specular component (SCI/SCE), and UV light quantity as when performing zero calibration using the software.

In the fluorescent measurement that does not require rigorous accuracy (that does not perform fluorescent calibration), perform measurement under the condition that the UV cut-off filter does not cover the xenon lamp (UV light quantity is 99.9).

Procedure

1. Pull the sample holder toward you and keep it open.

- The sample holder will remain open when opened more than 70 degrees.

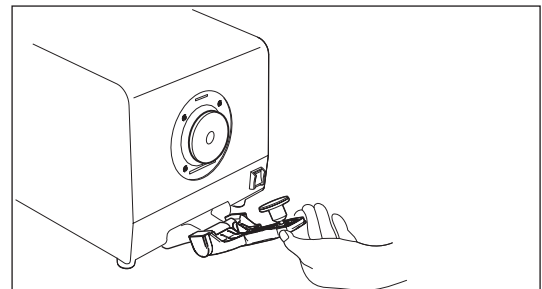

2. Position the white calibration plate so that it is held in place by the sample holder by fitting the sample holder pad into the concave (rear) side of the white calibration plate as shown at right.

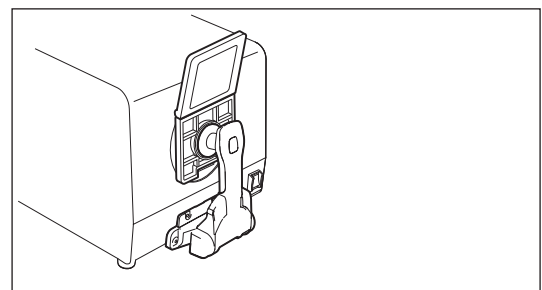

■ Notes on Use of White Calibration Plate

[Memo] • When performing white calibration, the white calibration data for the white calibration plate being used is required. The white calibration data for the white calibration plate included with the instrument is stored in the instrument's memory at the time of shipment.

- The white calibration plate may become discolored if left exposed to light. Therefore, when not in use, make sure that the lid is closed to prevent exposure to light.
- Take care not to scratch, touch, or make the white calibration plate surface dirty with such as fingerprints.
- If the white calibration plate gets dirty, wipe it with a soft, clean, dry cloth.
- If dirt is difficult to remove, dampen a cloth with commercially available lens cleaning liquid and wipe the white calibration plate. Then wipe off the liquid with a cloth dampened with water, and leave the plate to dry.
- Should the white calibration plate get so dirty that it cannot be cleaned, replace the plate with a new one.

■ Updating White Calibration Data

- You may use the "Data Setting Tool software" stored on the CD-ROM accompanying White Calibration Plate CM-A139 or the optional Color Data Software SpectraMagic™ NX to set the white calibration data.

Attaching the Transmittance Zero Calibration Plate (Optional Accessory)

The Transmittance Zero Calibration Plate is used for performing zero calibration for transmittance measurements.

- Before starting transmittance calibration and measurements, attach the LAV ($\varnothing 25.4$ mm) target mask and position the white calibration plate at the reflectance measuring port.
- Before starting transmittance calibration and measurements, set the measurement area to LAV and the specular component to SCI using the software.
- Before starting transmittance calibration and measurements, set the same UV light quantity as when performing measurements using the software. In the fluorescent measurement that does not require rigorous accuracy (that does not perform fluorescent calibration), perform measurement under the condition that the UV cut-off filter does not cover the xenon lamp (UV light quantity is 99.9).

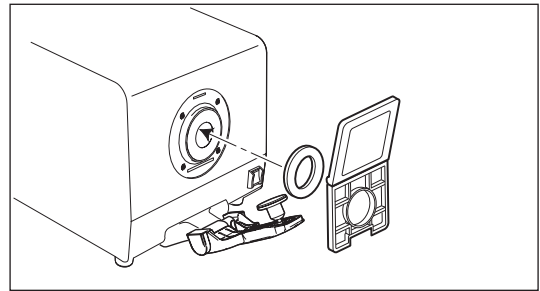

Procedure

1. Open the cover of the transmittance chamber.

2. Position the Transmittance Zero Calibration Plate in the transmittance chamber so that it completely blocks the illumination window.

[Memo] • When using the optional Transmittance Specimen Holder, position the Transmittance Zero Calibration Plate in the holder. For information on installing the optional Transmittance Specimen Holder, refer to the instructions included with it.

3. Close the cover of the transmittance chamber.

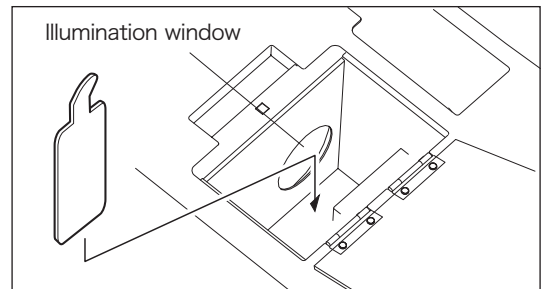

■ Notes on Use of Transmittance Zero Calibration Plate

- Take care not to scratch, touch, or make the surface of the transmittance zero calibration plate dirty with such as fingerprints.
- If the transmittance zero calibration plate gets dirty, wipe it with a soft, clean, dry cloth.
- If dirt is difficult to remove, dampen a cloth with commercially available lens cleaning liquid and wipe the zero calibration plate. Then wipe off the liquid with a cloth dampened with water, and leave the plate to dry.
- Should the transmittance zero calibration plate get so dirty that it cannot be cleaned, replace the plate with a new one.

Performing 100% calibration

Two methods for performing 100% calibration for transmittance measurements are possible:

- 100% calibration to air:

When the specimen to be measured is in sheet or solid form, 100% calibration should be performed with the transmittance chamber empty.

- 100% calibration to water:

When the specimen to be measured is in liquid form and will be measured using a cell (optional accessory), 100% calibration should be performed using distilled (or pure) water in the same size and type cell as will be used for measurements.

- Before starting transmittance calibration and measurements, attach the LAV ($\varnothing 25.4$ mm) target mask and position the white calibration plate at the reflectance measuring port.
- Before starting transmittance calibration and measurements, set the measurement area to LAV and the specular component to SCI using the software.
- Before starting transmittance calibration and measurements, set the same UV light quantity as when performing measurements using the software.

In the fluorescent measurement that does not require rigorous accuracy (that does not perform fluorescent calibration), perform measurement under the condition that the UV cut-off filter does not cover the xenon lamp (UV light quantity is 99.9).

After setting up the instrument as described below for your selected 100% calibration method, perform 100% calibration from your software.

■ Setting up instrument for 100% calibration to air

Procedure

1. Open the cover of the transmittance chamber.
2. Make sure that there is nothing (specimen, cell, Transmittance Zero Calibration Plate, etc.) between the illumination window and the receiving window in the transmittance chamber.

Memo • It is no problem that the optional Transmittance Specimen Holder CM-A96 is installed in the transmittance chamber.

3. Close the cover of the transmittance chamber.

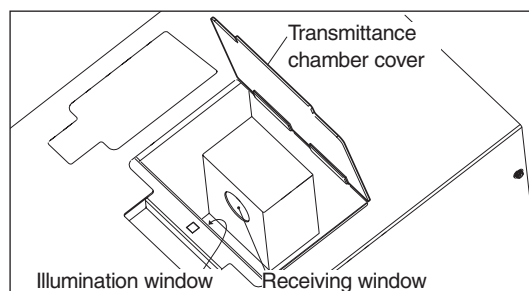
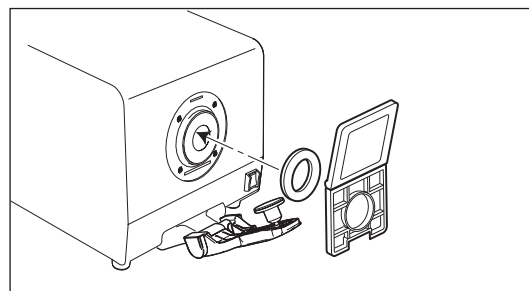

■ Setting up instrument for 100% calibration to water

Procedure

1. Open the cover of the transmittance chamber.
2. Fill the cell with distilled (or pure) water to approximately 2/3 (when using any of the cells available as optional accessories) and position the cell in the optional Transmittance Specimen Holder installed in front of the illumination window inside the transmittance chamber.

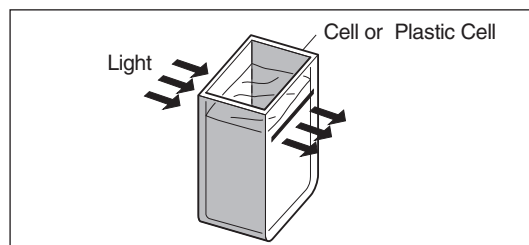

- Although the Transmittance Specimen Holder can be installed in front of either the illumination or receiving window, it is recommended that it is installed in front of the illumination window. In this position, the illumination / observation geometry is diffuse illumination/ 0° viewing angle.
- The cell used for calibration should be the same type and have the same optical path length as the cell which will be used for measurements.
- The cell should be positioned in the optional Transmittance Specimen Holder so that the clear sides of the cell are facing the illumination and receiving windows.
- The level of water in the cell should be above the top of the illumination and receiving windows when the cell is positioned in the optional Transmittance Specimen Holder.

3. Close the cover of the transmittance chamber.

Setting a Specimen



WARNING



Do not use the CM-3600A in places where flammable or combustible gases (gasoline fumes, etc.) are present. Doing so may cause a fire.



Do not disassemble or modify the CM-3600A. Doing so may cause a fire or electric shock.



The CM-3600A should not be operated if it is damaged, or smoke or strange odors occur. Doing so may result in a fire.

In such situations, turn the power OFF immediately, disconnect the AC adapter from the AC outlet, and contact the nearest Konica Minolta-authorized service facility.



CAUTION



Do not perform measurement with the specimen measuring port directed towards your face. Doing so may cause damage to your eyes.



Be careful around openings in the CM-3600A. Failure to do so may result in fingers being trapped causing injury.

■ Reflectance measurement P. 22

To measure the reflectance of a film - or plate-like specimen, the specimen needs to be secured with the sample holder. If the specimen cannot be secured in this way, remove the sample holder and hold the specimen against the measurement aperture.

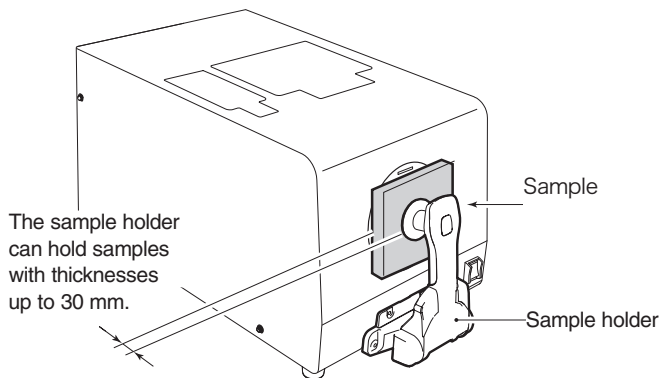

■ Transmittance measurement P. 23

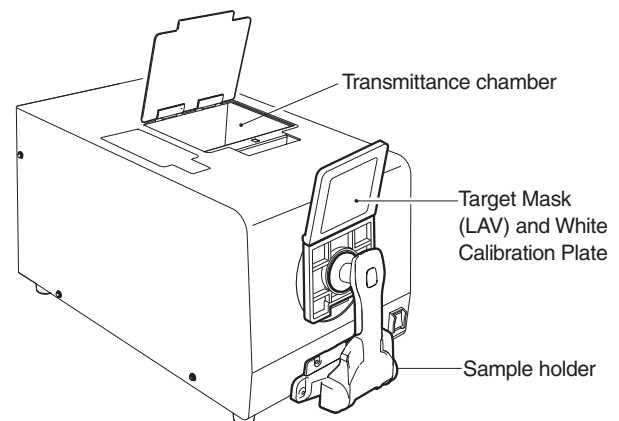

When measuring specimens that are thicker than 30 mm

■ Removing the Sample Holder

Procedure

1. Use a Philips screwdriver to turn the two screws counter-clockwise to remove the sample holder.

- Keep the screws and sample holder in a safe place.

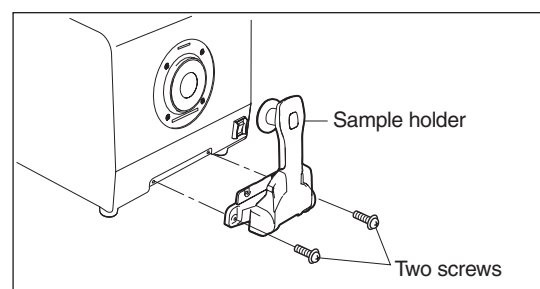

■ Reflectance measurement

- Make sure that there is nothing in the transmittance chamber.
- Before starting reflectance measurements, attach the target mask to be used for measurements.
- Before starting reflectance measurements, set the measurement area, specular component, and UV light quantity using the software.

Procedure

1. Pull the sample holder toward you and keep it open.

- The sample holder will remain open when it is opened more than 70 degrees.

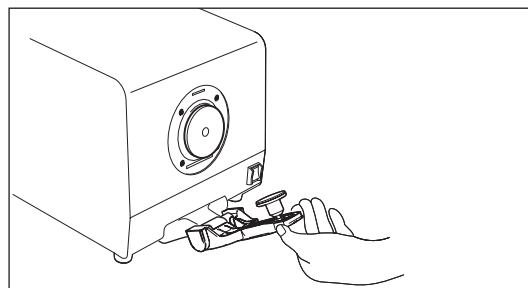

2. Secure the specimen with the sample holder.

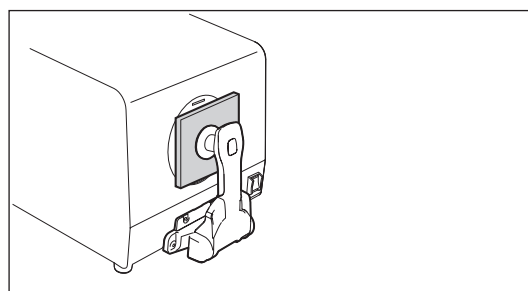

3. Open the viewfinder cover and check the measuring point.

- Memo** • When checking the measuring point while you are seated, position the viewfinder cover at the desired angle so that the image reflected in the mirror inside the viewfinder cover can be observed .
- When the viewfinder cover is opened, the specimen will be illuminated for 60 seconds by a lamp to enable you to check the measuring point.

- Do not exert excessive force on the viewfinder cover while it is open.
- It is not possible to perform measurement if the viewfinder cover is open.

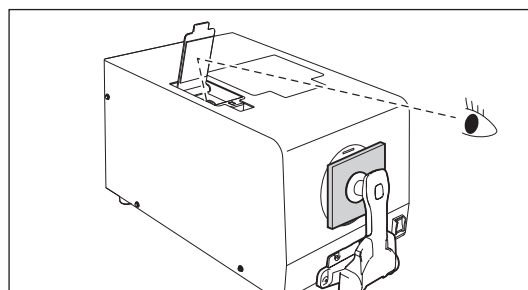

4. Adjust the position of the specimen so that the area to be measured is centered in the measurement aperture and then close the viewfinder cover.

- When adjusting the position of the specimen, the sample holder must be pulled and kept open. This will prevent the sample holder from scratching the surface of the specimen during adjustment.

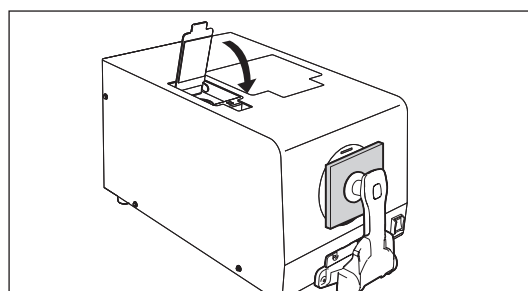

■ About opacity measurements

When using the optional Color Management Software SpectraMagic™ NX, pairs of white-backed and black-backed measurements can be taken and opacity can be calculated.

■ Transmittance measurements

- Before starting transmittance calibration and measurements, attach the LAV ($\phi 25.4$ mm) target mask and position the white calibration plate at the reflectance measuring port.
- Before starting transmittance calibration and measurements, set the measurement area to LAV and the specular component to SCI using the software.
- Before starting transmittance calibration and measurements, set the UV light quantity using the software.

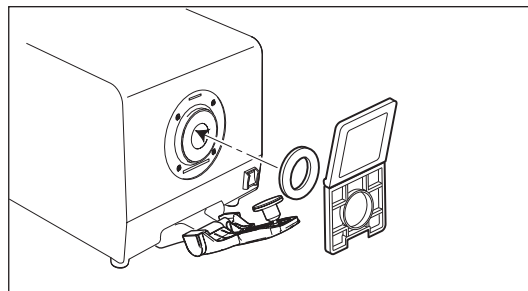

Procedure

1. Open the cover of the transmittance chamber.

2. Place the specimen against the illumination window tightly. (When measuring a liquid specimen, the specimen container must be placed against the illumination window.)

- The specimen must be placed so that the area to be measured entirely covers the entire illumination window.

Memo • Although the specimen can be placed in front of either the illumination or receiving window, it is recommended that it is placed in front of the illumination window. In this position, the illumination/observation geometry is diffuse illumination/ 0° viewing angle. In the position in front of the receiving window, the illumination/observation geometry is approximately $0^\circ : 0^\circ$. It does not strictly satisfy the definition of such as CIE No.15. However, this presents no problem if the values are used as relative values.

- It is recommended that the optional Transmittance Specimen Holder CM-A96 be used to hold the specimen in place.
- In the case of a liquid specimen, use of an optional cell (CM-A97 to 99, A130 to 132) is recommended.
- If you are going to use a container other than the above cells, it must be transparent and constructed in such a way that it can be positioned with opposing surfaces parallel to both illumination and receiving windows.
- Take care not to spill the liquid specimen on the CM-3600A. Should there be any spillage, immediately wipe it with a soft, dry cloth.
- Never measure flammable liquids.
- No measurements must be performed if the specimen or inside and outside of the specimen container is scratched or dirty. If you hold the measuring surface of the specimen with your fingers, it will be marked with fingerprints, so always hold another part of the specimen when setting it in place.
- Air bubbles on the inner surface of the specimen's container will hinder correct measurements, so make sure that all air bubbles are removed before measurement. (Air bubbles sometimes develop even if the container is just left standing still.)
- Correct measurements will be hindered if water drops develop on the specimen or its container due to condensation.
- Liquids containing particles may cause unstable measurements due to precipitation of the particles.

3. Close the cover of the transmittance chamber.

■ About haze measurements

When the White Calibration Plate is positioned over the reflectance measuring aperture, the measurement geometry for transmittance measurements becomes $di:0^\circ$. When the Zero Calibration Box is positioned over the reflectance measuring aperture, the measurement geometry for transmittance measurements becomes $de:0^\circ$.

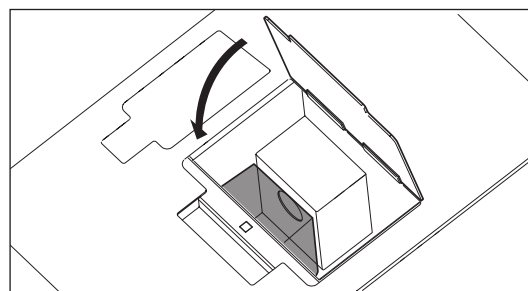
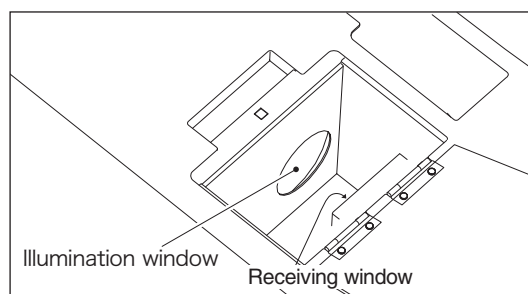
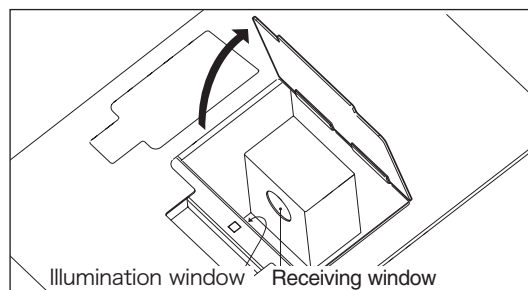

The illumination/observation system does not strictly satisfy the definition of haze (ASTM D 1003). However, this presents no problem if the values are used as relative values.

When using the optional Color Management Software SpectraMagic™ NX, these two types of transmittance measurements ($di:0^\circ$, $de:0^\circ$) with and without specimen can be taken and haze can be calculated.





Cleaning the CM-3600A and Accessories

WARNING

-  Do not disassemble or modify the CM-3600A or AC adapter. Doing so may cause a fire or electric shock.
-  The CM-3600A should not be operated if it is damaged, or if smoke or strange odors occur. Doing so may result in a fire. In such situations, turn the power OFF immediately, disconnect the AC adapter from the AC outlet, and contact the nearest Konica Minolta-authorized service facility.

CAUTION

-  When cleaning, disconnect the power plug. Connecting may cause electric shock.
-  Be careful around openings in the CM-3600A. Failure to do so may result in fingers being trapped causing injury.

■ Zero Calibration Box and White Calibration Plate

Wipe gently with a dry soft cloth. If dirt is difficult to remove, dampen a cloth with commercially available lens cleaning liquid and wipe. Then wipe off the liquid with a cloth dampened with water, and leave it to dry.

- When cleaning, take care not to scratch the zero calibration box or white calibration plate.

■ Target Mask

Use a blower to remove dirt and dust from the target masks.

- Do not touch the black-coated surface of the target masks with fingers or wipe it with a cloth. If the target masks get so dirty that dirt cannot be removed using a blower, contact the nearest Konica Minolta-authorized service facility.

■ Inside Integrating Sphere

1. Make sure that there is nothing placed against the illumination window.

2. Block the receiving window so that no dust or dirt enters.

3. Open the sample holder and remove dust and dirt using a blower.

- Do not touch the white-coated inner surface of the integrating sphere, wipe it with a cloth or place any object against it. If the white-coated surface gets so dirty that dirt cannot be removed using a blower, contact the nearest Konica Minolta-authorized service facility.

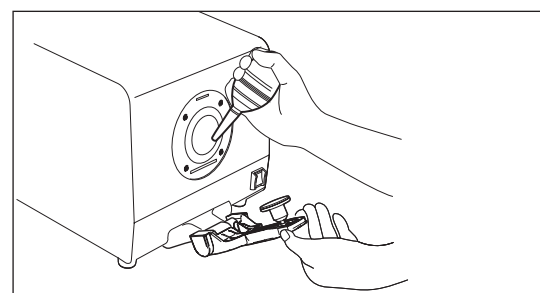
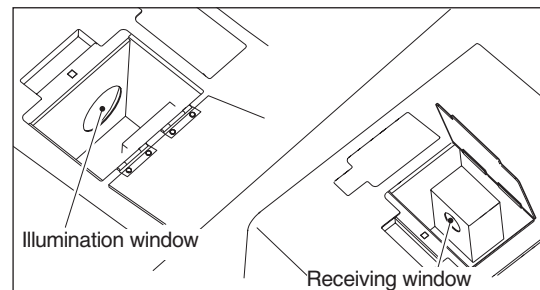

■ Receiving Window

1. Set the measurement area to SAV using your software.

-  **Memo** • This will cause the lens to move closer to the receiving window, making it easier to clean.

2. Use a blower to remove dirt and dust from the receiving window.

- Do not put your fingers into the receiving window or touch any optical lenses.

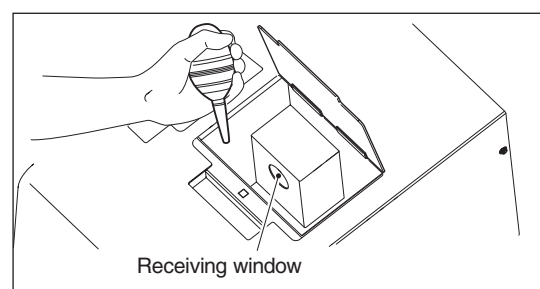

Error Message

The following error messages may appear when you use SpectraMagic® NX CM-S100w, optional color management software, to control the instrument. If you see an error message, follow the instructions shown in the table below. If a problem persists, contact the nearest Konica Minolta-authorized service facility.

Error Message	Problem / possible cause	Action	Refer to page
Time for Periodic Calibration. Please contact the closest Service Center.	It is time to perform periodic calibration.	Contact the nearest KONICA MINOLTA-authorized service facility and request periodic calibration.	—
File Open Error(Incorrect File Extension).	The file extension is incorrect.	Select the file that has the correct file extension.	SpectraMagic™ NX (optional) instruction manual.
Flash not ready.	The illumination unit has not been charged.	Contact a KONICA MINOLTA-authorized service facility.	—
File open error.	The calibration data file cannot be read properly.	Load the original calibration data file again. If the problem persists, contact the nearest Konica Minolta-authorized service facility.	SpectraMagic™ NX (optional) instruction manual.
Flash Error.	The xenon lamp failed to emit light. • Xenon lamp dead • Illumination circuit failure • Sensor failure"	Retry measurement or perform recalibration. If the message persists, contact the nearest Konica Minolta-authorized service facility.	—
Not Calibrated.	Zero calibration and white calibration have not been performed.	Perform zero recalibration and white calibration.	19, 20
Incorrect Calibration Procedure.	The calibration procedure is not correct. The count value is not appropriate for zero (0%) or white (100%) calibration.	Use the zero calibration box for zero calibration and the white calibration plate for white calibration.	17, 18
A/D Error.	A/D conversion failed. • A/D converter failure • Circuit failure"	Turn the power off and then on again. If the message persists, contact the nearest Konica Minolta-authorized service facility	15
EEPROM Error.	The EEPROM may be damaged.	Contact the nearest KONICA MINOLTA-authorized service facility.	
Circuit is not operating properly.	The motor for changing the measurement diameter, adjusting the UV light amount, or switching between SCI and SCE is not working.	Turn the power off and then on again. If the message persists, contact the nearest Konica Minolta-authorized service facility	15
Not Ready.	Charging for flashing the xenon lamp is not complete.	Wait for at least 3 seconds after the last flash. If the message persists, contact the nearest Konica Minolta-authorized service facility.	—

Error Message	Problem / possible cause	Action	Refer to page
Finder port is open.	The viewfinder cover stays open during measurement.	Close the viewfinder cover before measurement.	22
The measured object does not exhibit fluorescence.	UV adjustment is not allowed due to the UV specimen not containing fluorescence.	Perform UV adjustment using a specimen that contains fluorescence.	—
The fluorescent calibration coefficients could not be determined.	The fluorescent calibration coefficient cannot be determined.	Change Standard value or tolerance settings, or use a different Fluorescent Standard; then retry "UV adjustment".	—
No response from instrument	Communication with the instrument failed. <ul style="list-style-type: none"> • The power of the instrument is off. • COM port setting is incorrect. • Communication settings are incorrect. 	Turn on the power of the instrument. Check and correct the COM port and communication settings.	15
Detected instrument disagrees with connected one. Connect again.	The instrument is incorrect.	Connect CM-3600A.	—
File is different to current status.	The measurement conditions in the fluorescent calibration coefficient file (.krd) designated to be read are different from the actual measurement conditions.	Adapt the actual measurement conditions to the measurement conditions in the .krd file or select a file that corresponds with the actual measurement conditions.	SpectraMagic™ NX (optional) instruction manual.
UV adjustment not acceptable.	UV adjustment with a Ganz&Griesser option has not yet included all the required measurements.	Measure the fluorescent sample four times when selecting "Ganz&Griesser 4" or five times when selecting "Ganz&Griesser 5".	SpectraMagic™ NX (optional) instruction manual.

TROUBLESHOOTING GUIDE

If a problem occurs with the Spectrophotometer, please check the following points before requesting service. If the problem continues to occur even after the suggested corrective actions have been taken, contact the nearest Konica Minolta-authorized service facility.

Condition	Checkpoint	Recommended action	Refer to page
Reflectance measurement results seem strange.	Was specimen positioned correctly?	Open the viewfinder cover and check measurement point.	22
	Are the white calibration data correct?	Set the correct white calibration data.	18
	Was white calibration performed correctly?	Attach White Calibration Plate correctly and perform white calibration correctly.	18
	Was zero calibration performed correctly?	Attach Zero Calibration Plate correctly and perform zero calibration correctly.	17
	Is there any obstacle in the transmittance chamber?	Make sure that there is nothing in the transmittance chamber.	22
	Was measurement mode set to reflectance?	By referring to the operation manual of the software, perform the operation correctly.	—
Transmittance measurement results seem strange.	Was specimen positioned correctly?	Position specimen correctly.	23
	Was 100% calibration performed correctly?	Attach White Calibration Plate correctly and perform 100% calibration correctly using the appropriate calibration standard (air or distilled water).	20
	Was zero calibration performed correctly?	Attach White Calibration Plate correctly, block all light from reaching the receptor window, and perform zero calibration correctly.	19
	Was measurement mode set to transmittance?	By referring to the operation manual of the software, perform the operation correctly.	—
Data input/output between the Spectrophotometer and a computer cannot be performed. Commands cannot be input to the Spectrophotometer from a computer.	Is the USB cable connected correctly to both the Spectrophotometer and the computer?	Connect the USB cable correctly between the Spectrophotometer and the computer.	13
	Is the software operating correctly?	By referring to the operation manual of the software, perform the operation correctly.	—
		Set POWER switch of Spectrophotometer to OFF and then set it back to ON.	15



Explanations

Illumination/Observation System

■ Measuring Reflected Colors

The flow of measurement is shown below.

The geometry of the CM-3600A conforms to CIE No.15, ISO 7724/1, ASTM E 1164, DIN 5033 Teil 7, and JIS Z 8722 condition c (diffused illumination/perpendicular viewing system) standards, and offers both di:8° (SCI: specular component included ; Total reflectance) and de:8° (SCE: specular component excluded ; Diffuse reflectance) measurements.

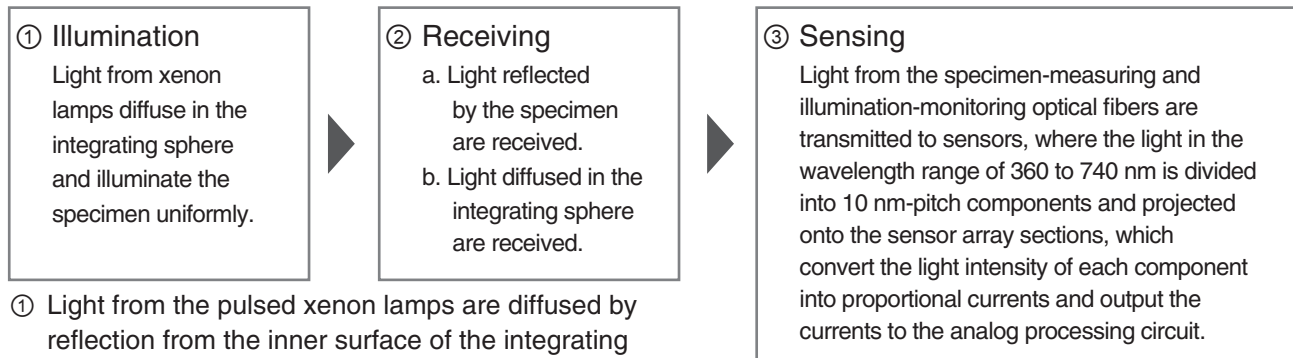

- ① Light from the pulsed xenon lamps are diffused by reflection from the inner surface of the integrating sphere, and finally illuminate the specimen uniformly.
- ② a. The light reflected by the specimen surface at an angle of 8° to the normal to the surface is received by the specimen-measuring optical system and guided to the sensor.
b. The diffused light in the integrating chamber is received by the illumination-monitoring optical fiber and guided to the sensor.
- ③ The light from the specimen-measuring optical fiber and from the illumination-monitoring optical fiber is divided into each wavelength component and projected onto the sensor array sections, which convert the light into proportional currents and output the currents to the analog processing circuit.

[Memo] • By using the outputs from the specimen-measuring sensor and the illumination-monitoring sensor for calculations, compensation for slight differences in the spectral characteristics and intensity of the illumination light is performed (double-beam system).

■ Measuring Transmitted Colors

The flow of measurement is shown below.

The geometry conforms to CIE No. 15, ASTM E1164, DIN 5033 Teil 7, and JIS Z 8722 condition g, and offers di:0° (SCI: Total transmittance) and de:0° (SCE: Diffuse transmittance) measurements.

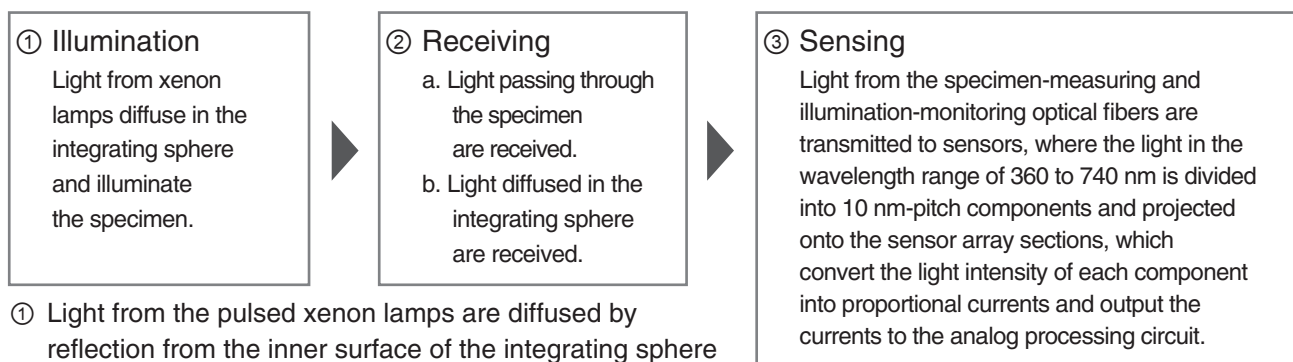

- ① Light from the pulsed xenon lamps are diffused by reflection from the inner surface of the integrating sphere and the surface of the white calibration plate covering the reflectance measurement aperture, and finally illuminate the specimen in the transmittance chamber.
- ② a. The light transmitted by the specimen is received by the specimen-measuring optical system and guided to the sensor.
b. The diffused light in the integrating chamber is received by the illumination-monitoring optical fiber and guided to the sensor.
- ③ The light from the specimen-measuring optical fiber and from the illumination-monitoring optical fiber is divided into each wavelength component and projected onto the sensor array section, which convert the light into proportional currents and output the currents to the analog processing circuit.

[Memo] • By using the outputs from the specimen-measuring sensor and the illumination-monitoring sensor for calculations, compensation for slight differences in the spectral characteristics and intensity of the illumination light is performed (double-beam system).

Illumination and Measurement Areas

The CM-3600A allows you to select a target mask from three types: LAV (for $\varnothing 25.4\text{mm}$ measurements), MAV (for $\varnothing 8\text{mm}$ measurements) and SAV (for $\varnothing 4\text{mm}$ measurements), according to the specimen and your application. Select and attach a suitable target mask (illumination area) for each measurement area.

■ Target Mask

Since the CM-3600A has no target mask detection function, it is not possible for the instrument to determine which target mask has been attached. Thus, when switching from one target mask to another, be sure that the intended target mask is attached and the instrument is properly set from the software. Furthermore, since the target masks are coated in black and measurement is influenced by the condition of this coated surface, do not touch this surface with your hands, scratch it or make it dirty.

■ Measurement Area

When the measurement area is switched from one to another, the condensing lens of the receiving optical system is moved by the motor according to the commands from the software running on a personal computer.

System Configuration

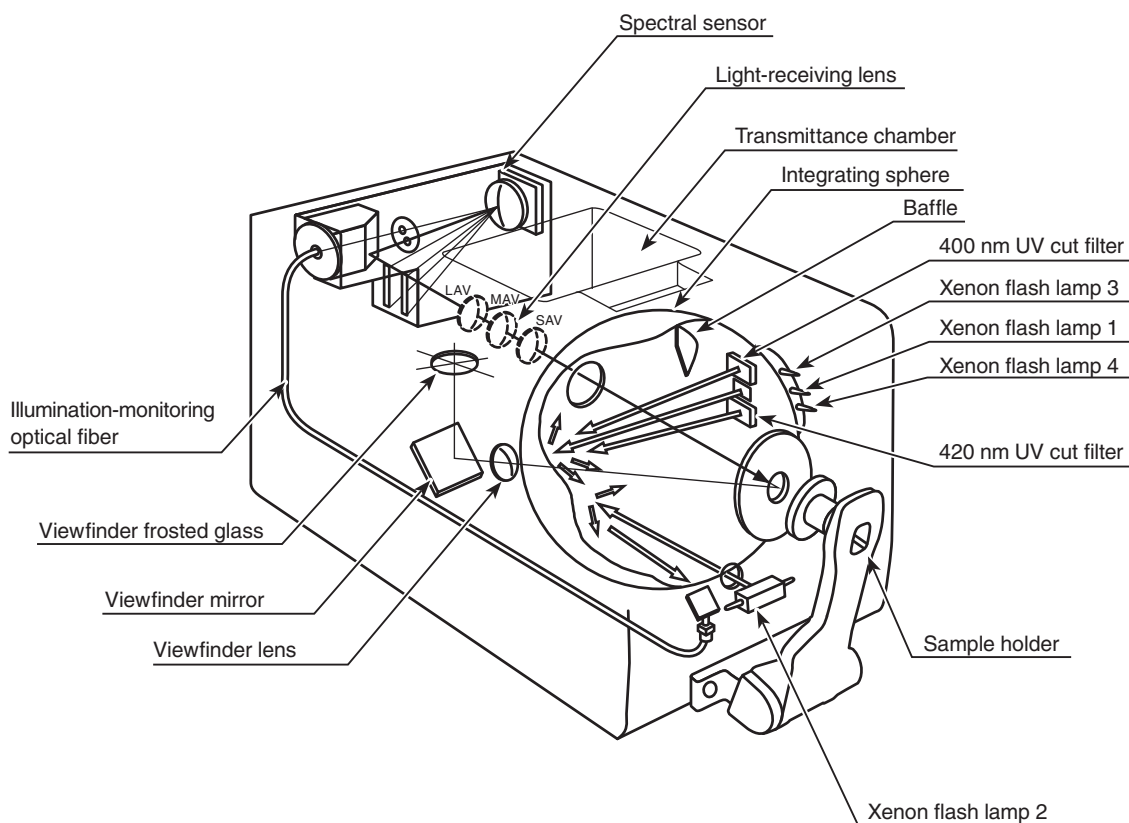

Overview of Simultaneous Measurement of SCI/SCE

The CM-3600A offers simultaneous measurement of SCI (specular component included)/SCE (specular component excluded).

With conventional models, SCI and SCE are switched mechanically by opening and closing an optical trap provided on the integrating sphere. This conventional method requires mechanical switching whenever SCI and SCE need to be switched. In addition, it is not possible to start measurement until switching is completed. The CM-3600A has eliminated mechanical switching and enables acquisition of SCI and SCE data by performing calculations with the measured data obtained using two light sources.

■ SCI/SCE SIMULTANEOUS MEASUREMENT

- Light sources ① and ② are located as illustrated at right. Light source ① flashes first.

Memo / • Light source ① is a normal diffused type, and enables the user to obtain SCI measurement data when it flashes.

- Next, light source ② flashes.

Memo / • Light source ② enables numerical control of specularly reflected light. The data obtained when this light source flashes (i.e., the amount of light on the surface of the specimen) and the one obtained when light source ① flashes can then be used to calculate the SCE measured data.

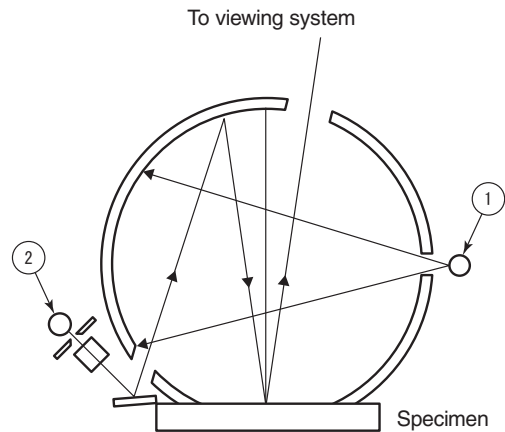

By performing the above measurement and calculation during each measurement, both SCI and SCE measurement data can be obtained simultaneously without the need for mechanical switching.

Fluorescent Measurement

The CM-3600A incorporates two types of xenon lamps as light sources for fluorescent measurements (UV full light source and UV cut light source) and performs numeric calculation of the reflectance when the specimen is illuminated by these two light sources to obtain fluorescent reflectance.

■ WHEN FLUORESCENT CALIBRATION IS PERFORMED:

When SpectraMagic™NX is used, the following four fluorescent calibration methods are available to enable accurate measurement of fluorescent reflectance.

1. Profile mode

Correction coefficients for fluorescent measurement are obtained based on the calibrated reflectance profile of the fluorescent standard plate (the reflectance profile is created by entering reflectance for each wavelength).

2. Tint mode

Correction coefficients for fluorescent measurement are obtained so that the measured CIE Tint value for the fluorescent standard plate is within the specified range (Tint value for the fluorescent standard plate calibrated with a D65 light source is entered).

3. Whiteness (WI) mode

Correction coefficients for fluorescent measurement are obtained so that the measured CIE WI (whiteness index) value for the fluorescent standard plate is within the specified range (WI value for the fluorescent standard plate calibrated with a D65 light source is entered).

4. Tint and WI mode

Correction coefficients for fluorescent measurement are obtained so that the measured CIE Tint and WI values for the fluorescent standard plate are both within the specified range (Tint and WI values for the fluorescent standard plate calibrated with a D65 light source are entered).

■ CALCULATING FLUORESCENT REFLECTANCE

Based on the measured reflectances for the fluorescent standard plate obtained under the UV full light source and under the UV cut light source, the amount of fluorescence is obtained. The correction coefficients for fluorescent measurement are then determined so that the given reference values are satisfied. (Calibration example: Profile mode)

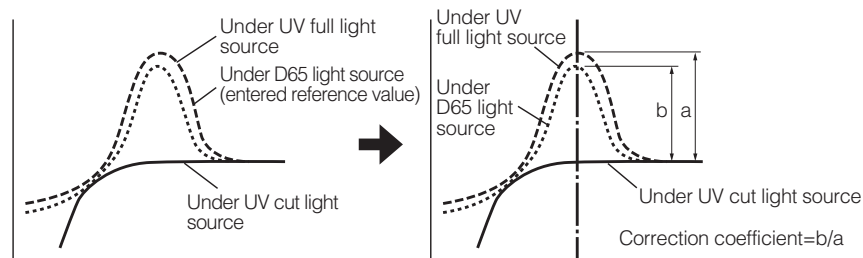

These correction coefficients are then used to obtain the fluorescent reflectance by performing numeric calculations using the measured reflectances under the UV full light source and under the UV cut light source. (The reflectances at cut wavelengths under UV cut light source are set to 0%.)

As a result, the CM-3600A can keep the fluorescent output quantity as close to the standard as possible, without the need for adjusting the quantity of ultraviolet light, which is required in the case of conventional models.

■ WHEN FLUORESCENT CALIBRATION IS NOT PERFORMED

The UV full xenon lamp of the CM-3600A has a spectral distribution similar to that of the D65 light source. Therefore, when high-accuracy fluorescent measurements are not required, normal measurement of reflectance can be used to measure fluorescent reflectance.

■ UV CUT LIGHT SOURCES

With the CM-3600A, UV400 cut light source (with radiation at wavelengths of 390 nm or lower eliminated) and UV420 cut light source (with radiation at wavelengths of 410 nm or lower eliminated) are provided.

Dimensions

(mm)

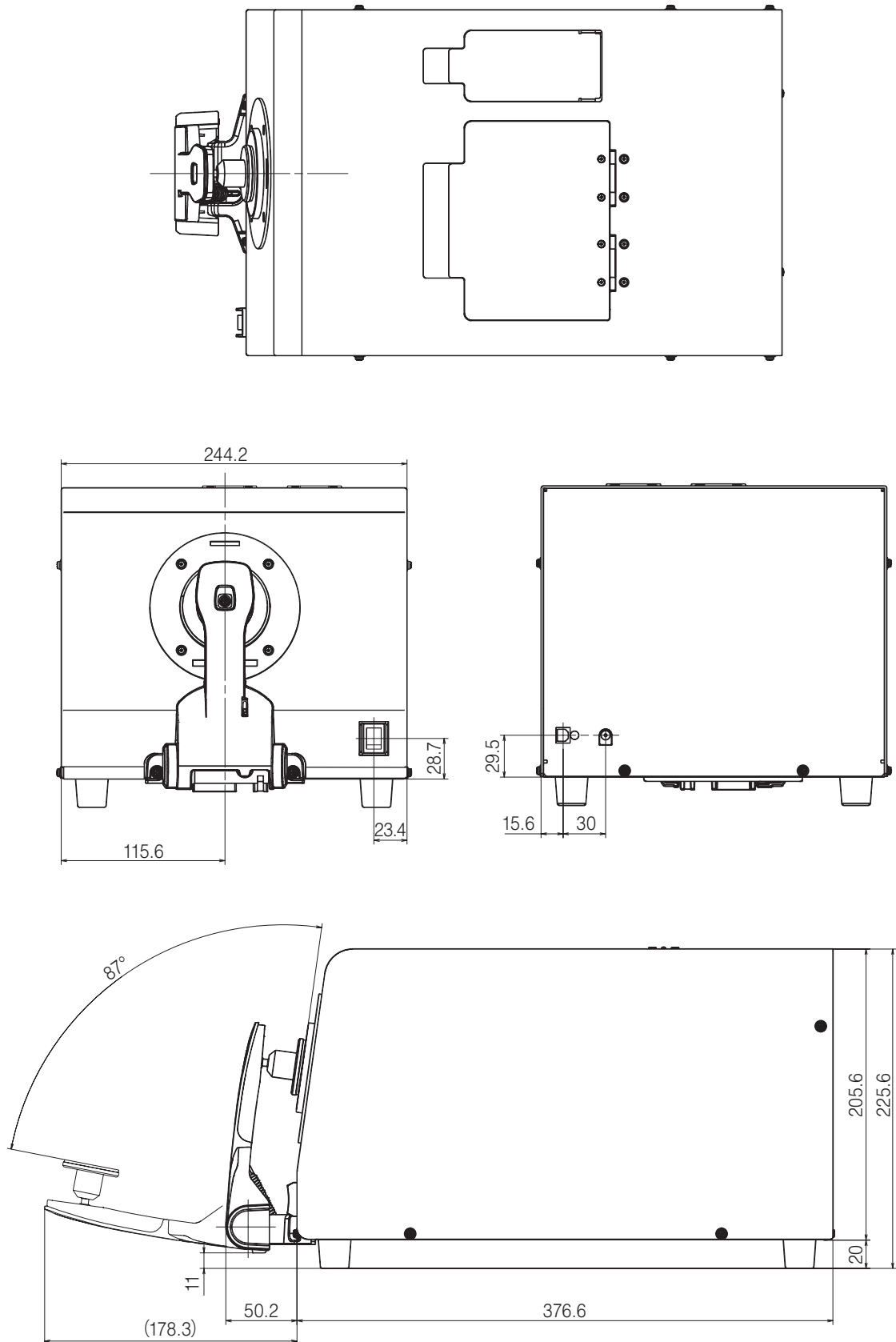

Specifications

Model	CM-3600A
Illumination/ observation system	Reflectance; di:8°, de:8° (diffused illumination, 8-degree viewing), equipped with simultaneous measurement of SCI (specular component included) / SCE (specular component excluded) Conforms to CIE No.15, ISO 7724/1, ASTM E 1164, DIN 5033 Teil 7 and JIS Z 8722 condition c standard. Transmittance : di:0°, de:0° (diffused illumination, 0-degree viewing) Conforms to CIE No.15, ASTM E 1164, DIN 5033 Teil 7 and JIS Z 8722 condition g standard.
Light-receiving element	Silicon photodiode array (dual 40 elements)
Spectral separation device	Diffraction grating
Wavelength range	360 to 740 nm
Wavelength pitch	10 nm
Half bandwidth	Approx.10 nm
Reflectance range	0 to 200%; resolution: 0.01%
Sphere size	ø152 mm
Light source	4 pulsed xenon lamps
Minimum interval between measurements	Normal SCI/ SCE measurement: 4 sec. Transmittance measurement: 3 sec. UV-cut/ UV-adjusted measurement: 5 sec.
Measurement/ illumination area (Selectable)	LAV : ø25.4 mm/ ø30 mm MAV : ø8 mm/ ø11 mm SAV : ø4 mm/ ø7 mm
Repeatability	When white calibration plate is measured 30 times at 10-sec. intervals after white calibration has been performed; Spectral reflectance: Standard deviation within 0.1% Colorimetric values: Standard deviation within ΔE^*_{ab} 0.02
Inter instrument agreement	Mean ΔE^*_{ab} 0.15 (LAV/SCI) Average for 12 BCRA Series II color tiles compared to values measured with master body.
UV adjustment	Instantaneous numerical adjustment
UV cut filter	400 nm cutoff and 420 nm cutoff
Transmittance chamber	Width: 133 mm; depth: approx. 50 mm; measurement dia.: approx. 17 mm Transmittance Specimen Holder (Optional accessory): Sample holder for both plate-shaped and liquid samples (removable)
Interface	USB 1.1
Power	AC100 to 240 V 50/60 Hz (Using included AC adapter)
Operating temperature/ humidity range (*1)	13 to 33°C, relative humidity 80% or less (at 33°C) with no condensation
Storage temperature/ humidity range	0 to 40°C, relative humidity 80% or less (at 35°C) with no condensation
Size (WxHxD)	244 x 205 x 378 mm
Weight	11.5 kg

- The specifications given here are subject to change without prior notice.

MEMO

< CAUTION >

KONICA MINOLTA WILL NOT BE LIABLE FOR ANY DAMAGES RESULTING FROM THE MISUSE, MISHANDLING, UNAUTHORIZED MODIFICATION, ETC. OF THIS PRODUCT, OR FOR ANY INDIRECT OR INCIDENTAL DAMAGES (INCLUDING BUT NOT LIMITED TO LOSS OF BUSINESS PROFITS, INTERRUPTION OF BUSINESS, ETC.) DUE TO THE USE OF OR INABILITY TO USE THIS PRODUCT.



KONICA MINOLTA